

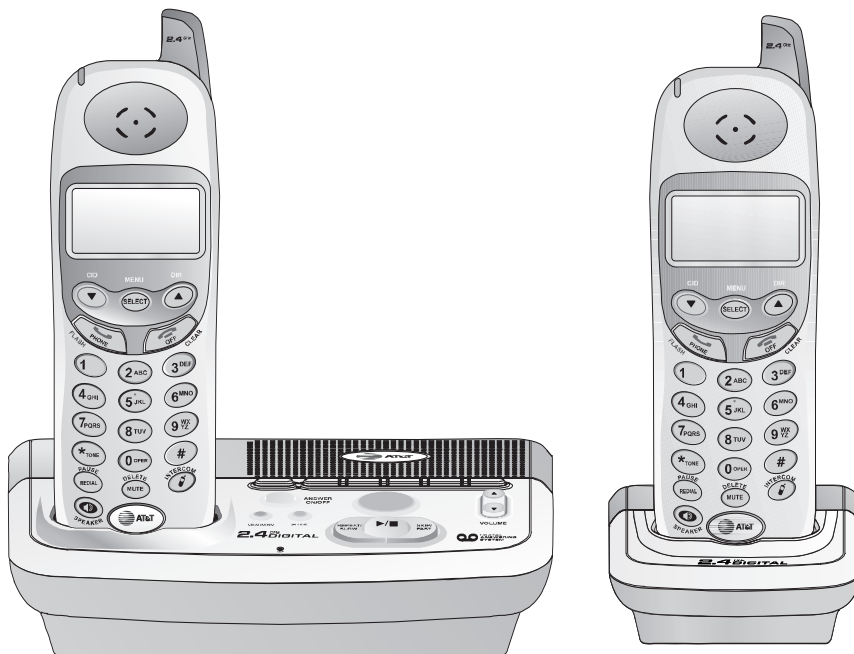

*User Manual (Part 2)*

## **2.4 GHz Cordless Telephone/Answering System E2725B**

**with Caller ID & Call Waiting**



**You must install and charge battery before using the telephone.**

**STOP!**

**See page 7 for easy instructions.**

For customer service or product information, visit our web site at **www.telephones.att.com** or call **1-800-222-3111**.

Please also read **Important Product Information** Enclosed in product package.



**CAUTION:** To reduce the risk of fire or injury to persons or damage to the telephone, read and follow these instructions carefully:

- Use only replacement battery 2419 (Part number 80-5543-00-00) or battery 2420 (SKU 00578. Part number 80-5542-00-00).
- Do not dispose of the battery in a fire, it could explode. Check with local codes for special disposal instructions.
- Do not open or mutilate the battery. Released electrolyte is corrosive and may cause damage to the eyes or skin. It may be toxic if swallowed.
- Exercise care in handling batteries in order not to short the battery with conducting materials such as rings, bracelets, and keys. The battery or conductor may overheat and cause harm.
- Charge the battery provided with or identified for use with this product only in accordance with the instructions and limitations specified in this manual.
- Observe proper polarity orientation between the battery and battery charger.

Do not disassemble your telephone. There are no user-serviceable parts inside. Refer for servicing to qualified service personnel.

User Manual (Part 2)

# 2.4 GHz Cordless Telephone/Answering System E2725B

with Caller ID & Call Waiting



## Table of contents

### Getting Started

- Quick reference guide .....2
- Parts checklist.....4
- Before you begin .....5
- Telephone base installation.....6
- Battery installation & charging .....7
- Wall mounting .....8
- Belt clip & optional headset.....9

### Telephone Operation

- Basic operation.....10
- Options while on calls .....11
- Intercom calls .....12
- Call Forward and Call Transfer .....13
- Handset settings.....14

### Phone book

- About the phone book.....16
- New phone book entries.....17
- Phone book search.....18
- To dial, change or delete entries ...19

### Caller ID Logs

- How Caller ID works .....20

- To review your call log.....21

### Answering System Operation

- Answering system operation .....22
- Day and time announcements .....23
- Outgoing announcements.....24
- Announce Only mode .....25
- Changing feature options.....26
- Message playback .....27
- Recording and playing memos .....28
- Message window displays.....29
- Remote access.....30

### Appendix

- Screen icons, indicator lights & tones...31
- In case of difficulty .....32
- Technical specifications .....34
- Index .....35
- Remote access wallet card .....36

Getting Started

**Quick reference guide**

**Handset**

**▼ CID**

Press to scroll down in menus. Press when phone is not in use to display Caller ID information (see page 21). While entering names, press to move the cursor to the left.

**Select/Menu**

Press to display menu, or to select highlighted item from menu.

**▲ DIR**

Press to scroll up in menus. Press when phone is not in use to display phone book entries (see page 16). While entering names, press to advance cursor.

**Phone/Flash**

Press to begin a call, then dial a number. During a call, press to receive an incoming call, if Call Waiting is activated (see page 11).

**Off/Clear**

During a call, press to hang up. While using menus, press to cancel an operation, back up to the previous menu, or exit the menu display.

**Redial/Pause**

Press to view redial memory (see page 10). While entering numbers, press and hold to insert a dialing pause (see page 17).

**Mute/Delete**

Press to mute microphone (see page 11). While reviewing call log, press and hold to clear Caller ID log (see page 21).

**Speaker**

Press to activate handset speakerphone. Press again to resume normal handset use (earpiece).

**Intercom**

Press to transfer a call or initiate an intercom conversation.

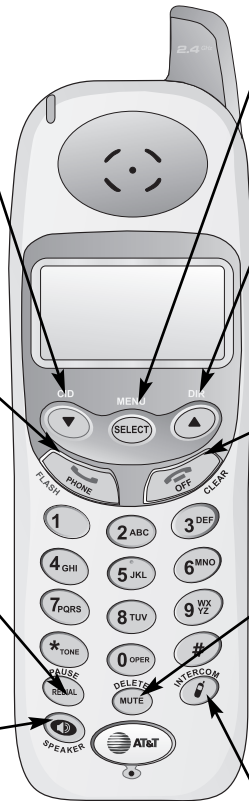

**Feature menu**

> shows highlighted item

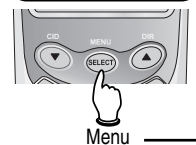
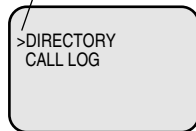

**Feature Menu**

- Directory .....See page 16
- Call Log .....See page 20
- Ringer Volume .....See page 14
- Ringer Tone .....See page 14
- Key Tone .....See page 14
- Handset Name .....See page 15
- Language .....See page 15
- CLR Voice Mail .....See page 15
- Dial Type .....See page 15

Press ▲ or ▼ to scroll through menu items.

Press **SELECT** to select or modify a highlighted item.

Press **OFF** to cancel an operation, back up to the previous menu, or exit the menu display.

Getting Started

**Quick reference guide**

**Telephone Base**

**Handset Locator**  
Press to locate handset if lost (see page 10).

**Volume**  
Press to adjust message playback volume.



**Charging**  
On when handset battery is charging.

**In Use**  
On when handset is in use. Flashes when another phone is in use on the same line, or answering system is answering an incoming call.



**Answering System Controls (see pages 22-30)**

Press to repeat message.  
Hold to slow playback.  
Press twice to hear previous message.

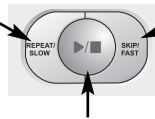

Press to skip to next message. Hold to speed up playback.

Press to play or stop playing messages.

- ON/OFF** .....Press to turn answering system on or off.
- DELETE** .....Press to delete message. Hold to delete all old messages.
- TIME SET** .....Press to review or set the answering system clock.
- MENU** .....Press to review or change answering system options.
- CHANGE** .....Press to change a menu option.
- RECORD** .....Press to record a memo or outgoing announcement.

Getting Started

## Parts checklist

Remember to save your sales receipt and original packaging in case you ever need to ship your telephone for warranty service. Check to make sure the telephone package includes the following:



Telephone base

Telephone handsets

Charger

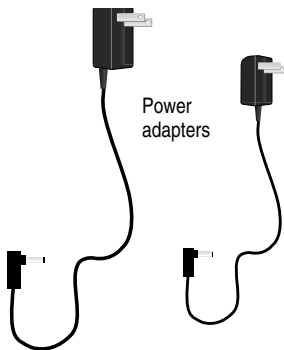

Power adapters

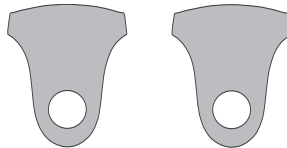

Belt clips

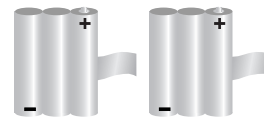

Batteries



telephone line cord

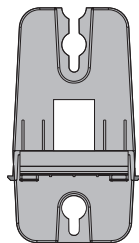

Wall mount bracket

*Getting Started*

## Before you begin

### About Caller Identification

Caller ID with Call Waiting features in this telephone let you see who's calling before you answer the phone, even when you're on another call. These features require services provided by your local telephone company.

Contact your telephone service provider if:

- You have both Caller ID and Call Waiting, but as separate services (you may need combined service)
- You have only Caller ID service, or only Call Waiting service
- You don't subscribe to any Caller ID or Call Waiting services.

You can use this phone with regular Caller ID service, and you can use its other features without subscribing to either Caller ID or combined Caller ID with Call Waiting service. There may be fees for these services, and they may not be available in all areas.

Caller ID features will work only if both you and the caller are in areas offering Caller ID service, and if both telephone companies use compatible equipment.

See Caller ID Operation, beginning on page 20, for more details about how these features work.

### Telephone operating range

This cordless telephone operates with the maximum power allowed by the Federal Communications Commission (FCC). Even so, this handset and base can communicate over only a certain distance — which can vary with the locations of the base and handset, the weather, and the construction of your home or office.

**If you receive a call while you are out of range**, the handset might not ring — or if it does ring, the call might not connect when you press **PHONE**. Move closer to the base, then press **PHONE** to answer the call.

**If you move out of range during a phone conversation**, you might hear noise or interference. To improve reception, move closer to the base.

**If you move out of range without pressing OFF**, your phone will be left off the hook. To hang up properly, walk back toward the telephone base, periodically pressing **OFF** until the call is disconnected.

*Getting Started*

## Telephone base installation

Install the telephone base as shown below. Choose a base location away from electronic equipment, such as personal computers, television sets or microwave ovens. Avoid excessive heat, cold, dust or moisture.

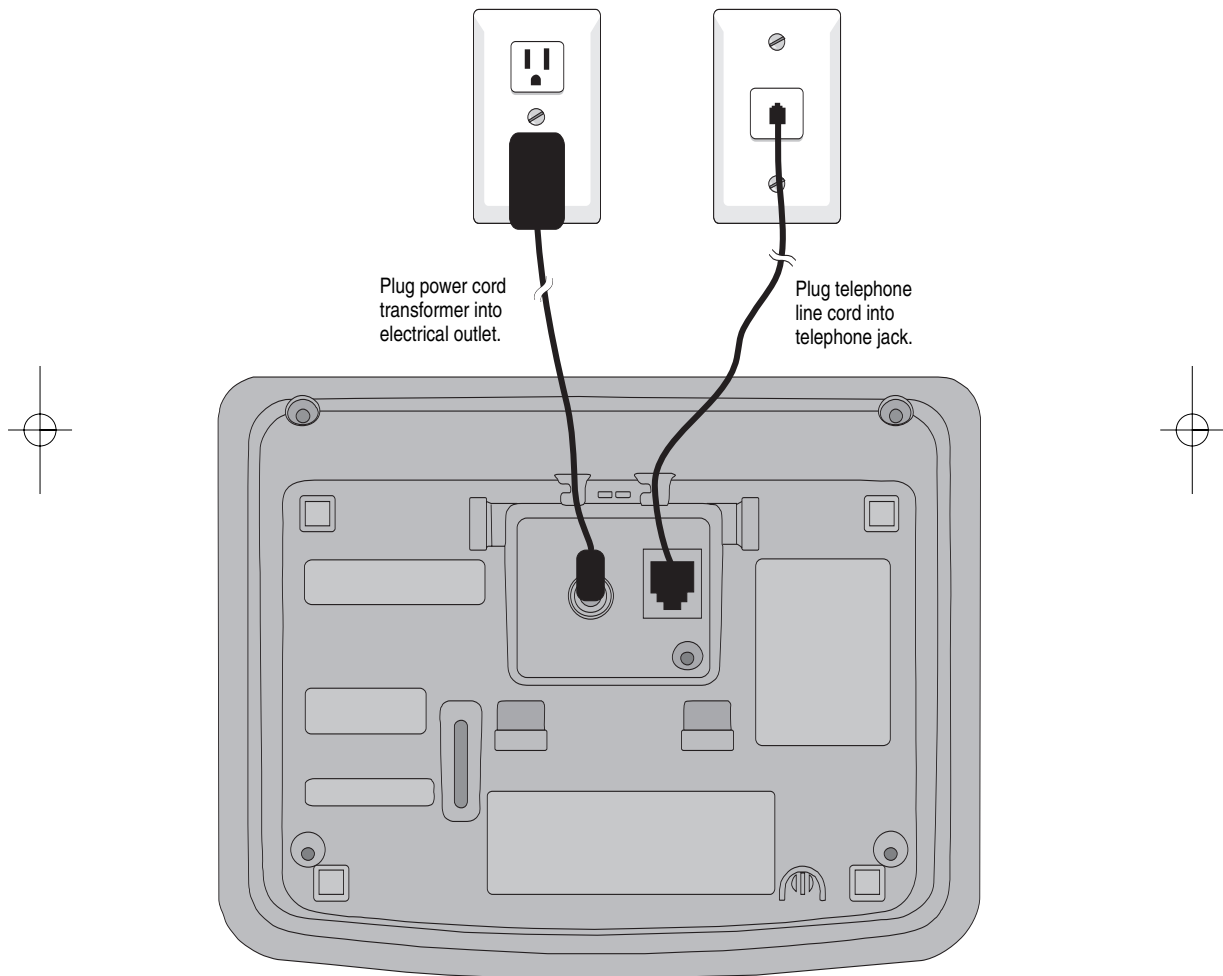

**NOTE:** Use only the power cord supplied with this product. If you need a replacement, call 1-800-222-3111. Be sure to use an electrical outlet not controlled by a wall switch.



Getting Started

## Battery installation & charging

After battery installation, place the handsets in their base unit or charger and allow to charge for 12 hours before use. You can keep the batteries charged by returning the handsets to their base unit or charger after each use. When the battery is fully depleted, a recharge takes about 10 hours. Average talk time on a fully charged battery is about six hours depending on environmental conditions, standby time is approximately four days.

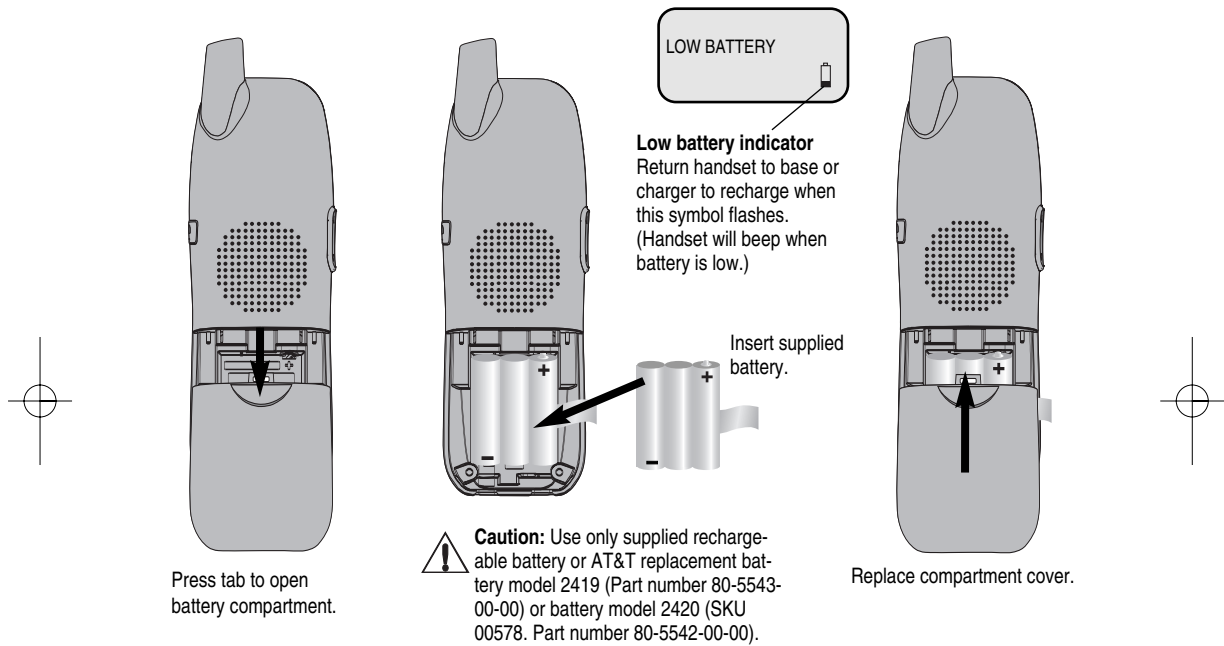

Plug charger power cord into jack on underside of charger, then plug transformer into electrical outlet.

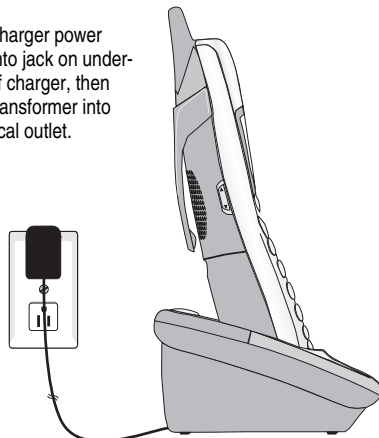

Place handset in base or charger to charge for 12 hours before first use.



*Getting Started*

## Wall mounting

The base can be installed on any standard wall-phone outlet as shown below. Choose a location away from electronic equipment, such as personal computers, television sets or microwave ovens. Avoid excessive heat, cold, dust or moisture.

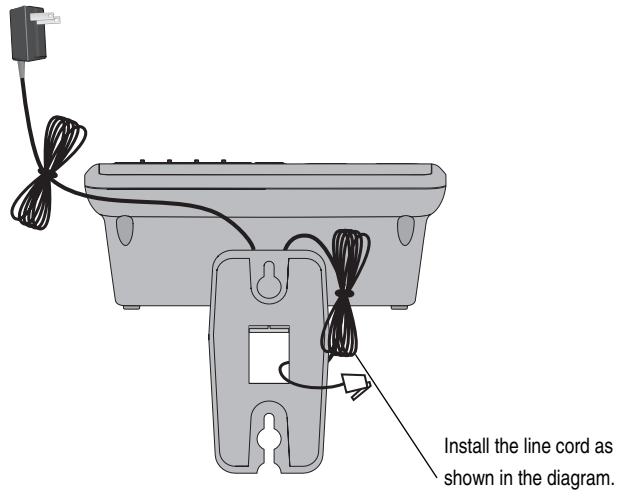

Connect cords as shown on page 6, then press and slide down firmly so base is held securely on outlet mounting pegs.

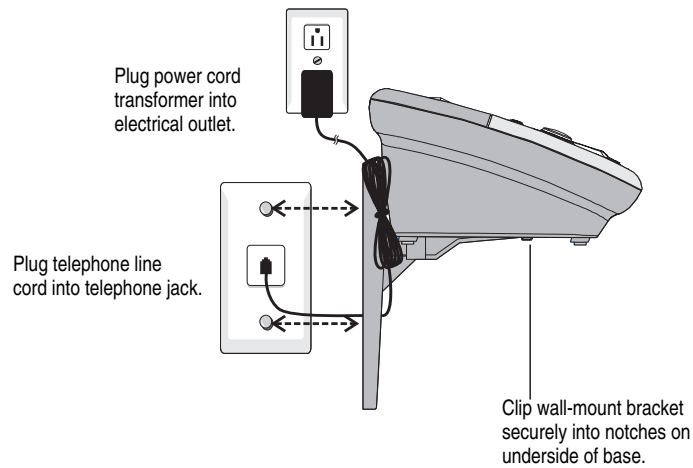

*Getting Started*

## Belt clip & optional headset

Install belt clip as shown below if desired.

For hands-free telephone conversations, you can use any industry standard 2.5 mm headset (purchased separately). For best results use an AT&T 2.5 mm headset.

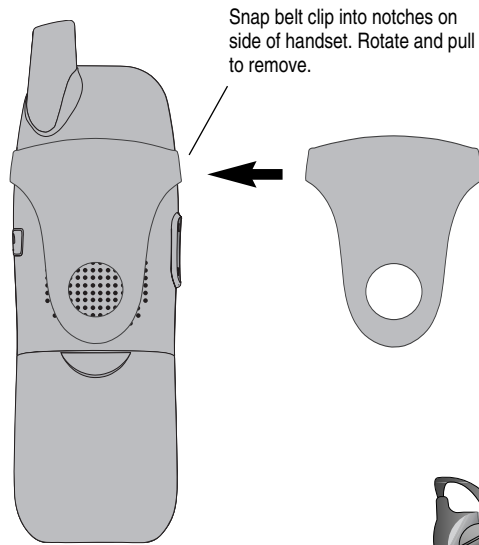

Telephone Operation

## Basic operation

### Making and answering calls

To answer an incoming call, press **PHONE** (or **SPEAKER**, or any dial pad key). To make a call, press **PHONE** or **SPEAKER**, then dial a number. Press **OFF** to hang up.

To preview numbers before dialing, enter numbers first, then press **PHONE** or **SPEAKER** to dial. Press **DELETE** or **CLEAR** at any time to make corrections as you are entering numbers.

The screen displays the elapsed time as you talk (in hours, minutes and seconds).

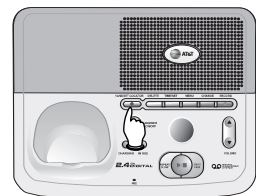
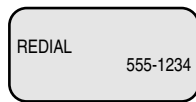
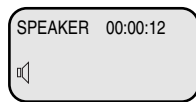
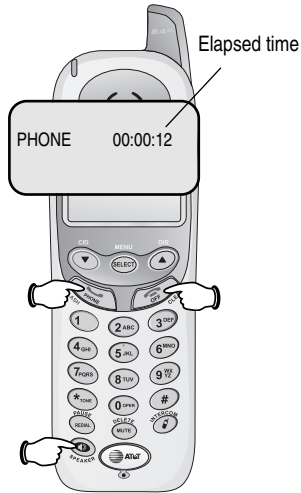

### Hands-free speakerphone calls

To answer a call, press **SPEAKER**. To make a call, press **SPEAKER**, then dial a number. During a call you can press **SPEAKER** to toggle between hands-free speakerphone and normal handset use. Press **OFF** to hang up.

### Last number redial

Press **REDIAL** to display the most recent called number (up to 32 digits). Use the **▲** **▼** buttons to view up to five other recently called numbers. The handset will beep twice at the beginning or end of the list.

Press **PHONE** to redial any displayed number. Press **DELETE** to delete the number from the redial memory.

### Handset locator

If you misplace the handset, press **HANDSET LOCATOR** at the base. The handset will beep for 60 seconds to help you locate it. To stop the beeping, press **PHONE**, **SPEAKER**, or any dial pad button at the handset, or press **HANDSET LOCATOR** at the base.

Telephone Operation

**Options while on calls**



**Volume control**

Press the **VOLUME** buttons on the side of the handset to adjust listening volume. Each button press raises or lowers volume by one level.

When you change the volume level, the new setting becomes the default. The new volume level will be applied each time you use the handset, speakerphone or headset.

**Call waiting**

If you have Call Waiting service, you will hear a beep if someone calls while you are already on a call. Press **FLASH** to put your current call on hold and take the new call. You can press **FLASH** at any time to switch back and forth between calls.

**3-way conference calls**

During an outside call, you can use two system handsets for a three-way conversation.

While a call is in progress, others can press **PHONE** or **SPEAKER** to join the conference call. Others can press **OFF** or place the handset in the base or charger to drop out of the conference call, but the call will not be terminated until all handsets hang up.

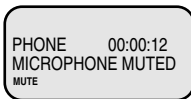

**Mute**

Press **MUTE** to silence the microphone. You will be able to hear, but your caller will not be able to hear you until you press **MUTE** again and resume speaking.

**Ring silencing**

Press **OFF** or **MUTE** while the phone is ringing to silence the ringer.

**Temporary tone dialing**

If you have dial pulse (rotary) service, you can switch to touch tone dialing during a call by pressing **TONES**. This can be useful if you need to send tone signals for access to answering systems or long-distance services.



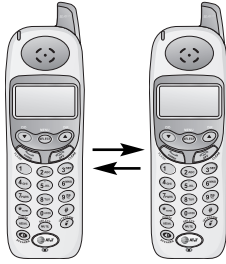

### Telephone Operation

## Intercom calls

### Intercom calls

Use the intercom feature to have conversations between the handsets.

Press the **INTERCOM** button on a handset to initiate an intercom call. This handset will call the other handset.

Press **PHONE**, **INTERCOM**, **SPEAKER** or any dial pad key on the handset being paged to enter intercom mode with the first handset.

To end the intercom call:

- Press **OFF** or **INTERCOM** at the handset.
- Place the handset in the charger or base.



**NOTE:** The intercom feature cannot be utilized while either handset is in the phone book or call log.

### Handling incoming calls

The phone will beep if you receive an outside call during an intercom conversation. You can either:

- Press **PHONE** to end the intercom call and answer the incoming call.

**OR**

- Press **INTERCOM** or **OFF** to disconnect the intercom connection without answering the incoming call. The incoming call will continue to ring.

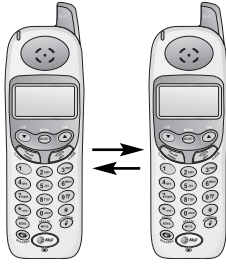

### Telephone Operation

## Call Forward and Call Transfer

### Call Forward and Call Transfer

An external call can be forwarded or transferred from one handset to the other. The difference between forward and transfer depends on if the sending handset needs to talk with the receiving handset before the external call is sent to the other handset.

#### Call Forward

- The first handset (HS1) can forward an external call to the other handset (HS2) by pressing and holding the **INTERCOM** key. HS1 will display **CALL FORWARDED**.
- To answer the call, HS2 can press **PHONE**, **SPEAKER** or any of the dial pad keys.



**NOTE:** If HS2 does not respond within 30 seconds, the external call will be returned to HS1 and its display will show **CALL BACK**. If the returned call is not answered within 30 seconds, the external call will end automatically.

#### Call Transfer

- HS1 can transfer an external call to HS2, by pressing the **INTERCOM** key.



**NOTE:** The external call is put on hold automatically.

- HS2 will ring, showing an intercom call.
- Press **PHONE**, **INTERCOM**, **SPEAKER** or any dial pad key on HS2 to answer the intercom call.
- HS1 and HS2 can discuss the external call.



**NOTE:** Press **INTERCOM** on HS1 to switch back and forth between the intercom and outside call.

- Press **OFF** on HS1 to transfer the call. HS2 is now on the external call. **CALL TRANSFERRED** will display on HS1.



**NOTE:** If there is no answer on HS2 within approximately 1.5 minutes, HS1 will automatically reconnect to the external call.

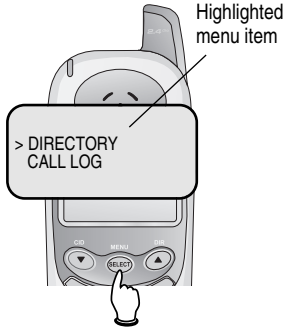

*Telephone Operation*

## Handset settings

At the feature menu you can change settings to customize how the telephone works.

Press **MENU**, then use the **▲ ▼** buttons to scroll to the feature you want to change. As you scroll through the menu, the top menu item is always highlighted with a **>** symbol. Press **SELECT** to select the highlighted item.

Press **OFF** at any time to cancel an operation, back up to the previous menu, or exit the menu display.

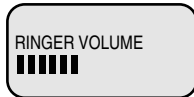

### Ringer volume

At this menu you can set a default ring volume level (1-6), or turn the ringer off. Use the **▲ ▼** buttons to hear an example of each volume level, then press **SELECT** to select the one you prefer.

Ringer volume can also be adjusted by pressing **VOLUME** on the side of the handset during incoming ringing.

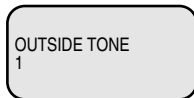

### Ringer tone

This feature allows you to choose one of 10 ringing tones. Use the **▲ ▼** buttons to hear an example of each ringer tone, then press **SELECT** to select the one you prefer.

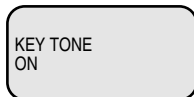

### Key tone

The handset is factory programmed to beep at each key press. Use the **▲ ▼** buttons to select **ON** or **OFF**, then press **SELECT** to save your preference.



*Telephone Operation***Handset settings**HANDSET NAME  
AT&T\_**Handset name**

At this menu you can customize the name that appears on the handset screen when the phone is idle. Press **DELETE** to erase letters, then replace them with a name of your preference, up to 16 characters long (see page 17 to enter letters). Press **SELECT** to confirm.

LANGUAGE  
ENGLISH**Language**

At this menu you can select the language used in all menus and screen displays. Use the **▲ ▼** buttons to select English, Spanish or French, then press **SELECT** to save your preference.

DIAL TYPE  
TONE**Dial Type**

At this menu you can choose Tone or Pulse dialing. The factory default setting is **TONE**. Change this to **PULSE** only if you do not have touch-tone dialing service.

Use the **▲ ▼** buttons to select **TONE** or **PULSE**, then press **SELECT** to save your preference.

>DIRECTORY  
CALL LOG**CLR Voice Mail**

If you subscribe to voice mail services provided by your local telephone company, you will receive a text message on the handset when you have new voice mail. To manually remove the voice mail message on the display:

- Press **MENU**.
- Press the **▲** or **▼** button to highlight CLR VOICE MAIL is selected.
- Press **SELECT**.
- Press **SELECT** again to remove the displayed message, or press **OFF** to exit.

>CLR VOICE MAIL  
DIAL TYPETURN INDICATOR  
OFF?>CLR VOICE MAIL  
DIAL TYPE

**NOTE:** This only turns off the displayed message on the handset, it does not delete your voice mail message(s).

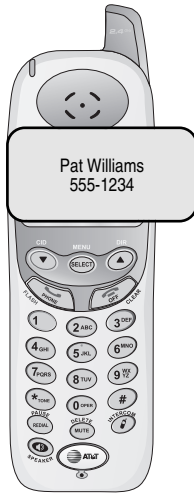

## Phone book

### Shared phone book directory

---

The phone book directory is stored in the base, and is shared by both handsets. Changes made at either handset will be reflected in both.

Only one handset at a time can use the phone book. If a second handset attempts to use the phone book, the screen will display **NOT AVAILABLE AT THIS TIME**.

### Memory capacity

---

The phone book directory can store up to 50 entries. Each entry can contain a number up to 32 digits, and a name up to 16 letters long. A convenient search feature can help you find and dial numbers quickly (see page 18).

### Timeouts and error messages

---

If you pause for too long while making an entry, the procedure will time out and you will have to begin again.

If all memory locations are in use, the screen will display **DIRECTORY IS FULL**. You will not be able to store a new number until you delete an existing one.

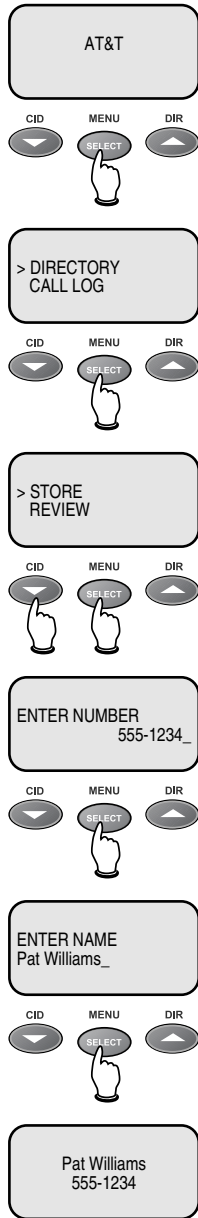

Phone book

## New phone book entries

### To create a new phone book entry

Press **MENU** twice to select **DIRECTORY**. Press **▼** to highlight **STORE**. Press **SELECT**, then enter the telephone number when prompted.

Use the dial pad to enter up to 32 digits, then press **SELECT**. You will be notified if the number is already in your phone book.

To insert a number from your redial list, press **REDIAL**, then **▲▼** to find the number, then press **SELECT**.

- Press **DELETE** to erase numbers if you make a mistake.
- Press and hold **PAUSE** to enter a 3-second dialing pause.

### To enter a name

Press dial pad buttons once for the first letter, twice for the second, three times for the third. Continue for lower-case letters or numerals.

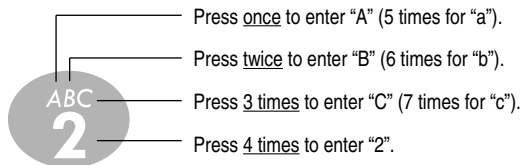

The cursor moves to the right when you press another dial pad button or the **▲** button. Press **▼** to move the cursor to the left. Press **1** to enter a space, or press twice to enter "I".

- Press **DELETE** to erase letters if you make a mistake.
- Press **\* (STAR)** repeatedly to enter an asterisk (\*), question mark (?), exclamation point (!), slash (/) or parentheses.
- Press **# (HASH)** repeatedly to enter a pound sign (#), apostrophe ('), comma (,) hyphen (-), period (.), or ampersand (&).

### Storing the entry

Press **SELECT** to store your new phone book entry. To change it later, see page 19.

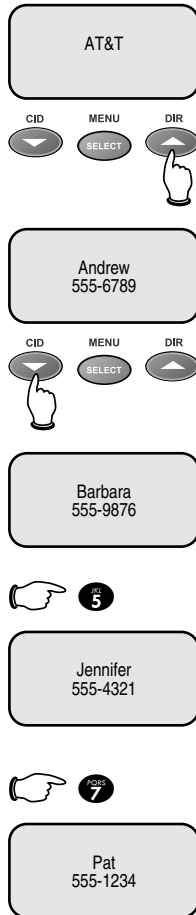

### Phone book

## Phone book search

Press **DIR** to display the first listing in the phone book. You can then use the **▲** or **▼** to browse through the phone book, or search to find a specific entry. Press **OFF** at any time to exit the directory.

### To browse through the directory

To browse, press **▲** or **▼** to scroll through all entries one by one. Entries will be displayed alphabetically by the first letter in the name.

### To search by name

When any entry is displayed, you can press a dial pad button to display the first name beginning with a letter associated with that key.

Press dial pad buttons once for the first letter, twice for the second, three times for the third, as shown on the previous page.

For example, press **5 (JKL)** once to find Jennifer, twice to find Kevin, or three times to find Linda.

### To call a displayed number

When you find the entry you want, press **PHONE** (or **SPEAKER**) to dial. Or press **SELECT** to modify the entry (see next page).

### Viewing long numbers

The screen can display only 16 digits at a time. To view numbers longer than this, press **\*#** or **#** to display the remaining digits.

*Phone book*

**To dial, change or delete entries**

**To dial a number**

When any phone book entry is displayed, press **PHONE** (or **SPEAKER**) to dial the displayed number.

**To delete an entry**

When any phone book entry is displayed, press **DELETE** to delete the displayed entry from the phone book. Once deleted, an entry cannot be recovered.

**To change a listing**

When any phone book entry is displayed, press **SELECT** to modify the entry. (See page 17 for help in modifying the name or number.)

Change the number as needed, then press **SELECT**. Change the name as needed, then press **SELECT** to save the modified entry.

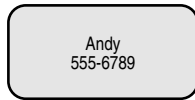
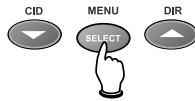
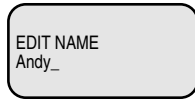
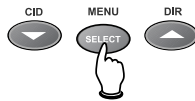
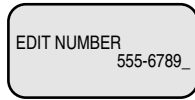
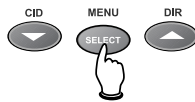
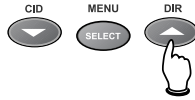
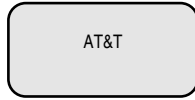



## Caller ID Logs

### How Caller ID works

If you subscribe to Caller ID service provided by your local phone company, information about each caller will be displayed after the first ring.

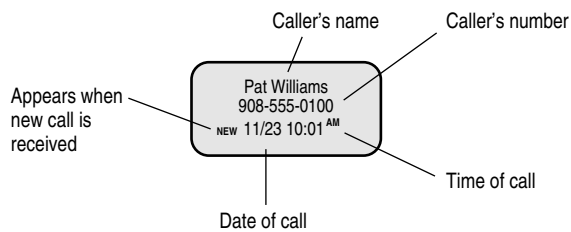

Information about the last 50 incoming calls is stored in your call log. You can review the call log to find out who has called, return the call without dialing, or copy the caller's name and number into your phone book.

When the call log is full, the oldest entry is deleted to make room for new incoming call information.

If you answer a call before the information appears on the screen, it will not be saved in your call log.



**NOTE:** Only one handset can review the call log at a time. If the other handset attempts to enter the call log, will display **NOT AVAILABLE AT THIS TIME**.

### About names

Names of callers will be displayed only if this information is provided by your local telephone company.

If the telephone number of the person calling matches a number in your phone book, the name that appears on screen will match the name as you entered it into your phone book.

(Example: If Christine Smith calls, her name will appear as **Chris** if this is how you entered it into your phone book.)

AT&T  
6 NEW CALLS  
NEW

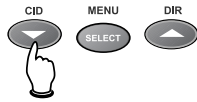

Pat Williams  
555-1234  
NEW 11/23 10:31 AM

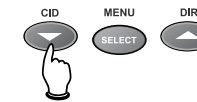

Chris Thompson  
908-555-0100  
NEW 11/23 10:21 AM

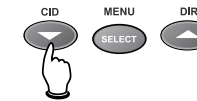

Jeffrey Adams  
555-9876  
NEW 11/23 10:11 AM

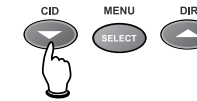

Caller ID Logs

**To review your call log**

**To review your call log**

Press **CID** to review your call log. The most recent call is displayed first. Use the arrow buttons to scroll through the list as shown at left.

**To return a call**

Press **PHONE** (or **SPEAKER**) to call the number as displayed.

To change the number before calling, press **#** repeatedly to see a list of dialing options (you can choose to dial with or without the area code), then press **PHONE** (or **SPEAKER**) to place the call.

**Example:**

- CID** .....Number displayed as **908-555-0100**
- #** (twice) .....Number changes to **555-0100** (drops "1" + area code)
- PHONE/**
- SPEAKER** .....Dials **555-0100**

**Other options**

- Press **DELETE** to delete this entry from your call log.
- Press and hold **DELETE** to delete all entries from your call log. When asked to confirm, press **SELECT** to clear your call log of all entries, or **OFF** to exit and leave all call log entries intact.
- Press **SELECT** to copy this entry into your phone book. If the name or number is not provided, you will be prompted to enter them.



**Message counter**

Number of messages (or, during playback, message number currently playing).

# Answering System Operation

## Message capacity

The answering system can record up to 99 messages, depending on the length of each message. Individual messages can be up to four minutes long, but total maximum recording time is 15 minutes. Messages will remain available for replay until you delete them.

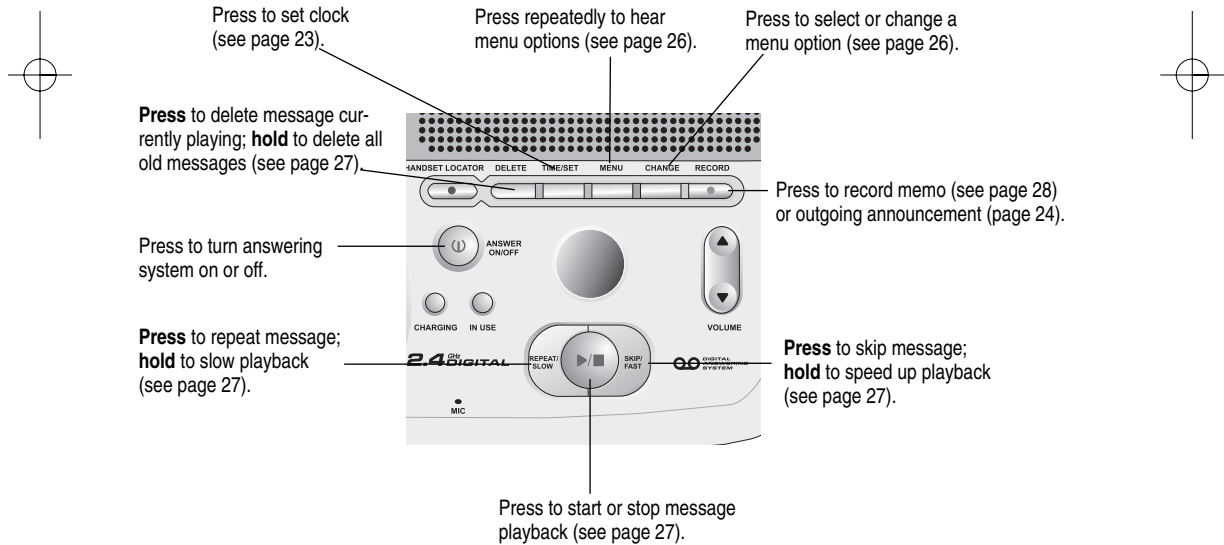



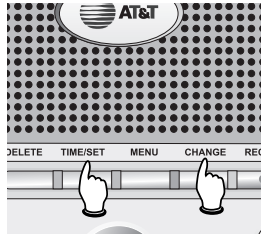



**1.** Make sure the answering system is on.

**2.**  Press **TIME SET**  
The system will announce the current clock setting, then announce is "To change clock, Press **TIME SET!**"

**3.**  Press **TIME SET**

**4.**  Press **CHANGE**  
until the system announces the correct day, then press **TIME SET**.

**5.**  Press **CHANGE**  
until the system announces the correct hour, then press **TIME SET**.

**6.**  Press **CHANGE**  
until the system announces the correct minutes, then press **TIME SET**.

 **NOTE:** You can press and hold **CHANGE** to advance the minutes in increments of ten.

**7.**  Press **CHANGE**  
until the system announces the correct year, then press **TIME SET**. The system announces the current clock setting.

## Answering System Operation

### Day and time announcements

#### To set day and time

Before playing each message, the answering system announces the day and time the message was received.

Before using the answering system, you should follow the steps at left to set the day and time, so messages are dated correctly.

The system uses voice prompts to guide you. Each time you press **CHANGE**, the day, hour, minute or year advances by one. When you hear the correct setting, press **TIME SET** to move to the next setting.

#### To check day and time

You can press **TIME SET** at any time to hear the current day and time without changing it.

 **NOTE:** Press and hold **CHANGE** to advance the minute or year by 10 (the year can be set from 2000 to 2039).

 **NOTE:** After you set the time once, it will thereafter be set automatically with incoming Caller ID information. The time will be set automatically only if you subscribe to Caller ID service provided by your local telephone company (see page 5).

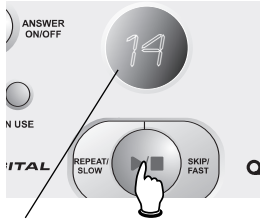

Elapsed recording time (seconds). Press to stop recording.

**1. MENU**

"Change announcement"

**2. (Play/Stop)**

(Plays announcement previously recorded).

**Or**

**2. RECORD**

"Now recording..."

**3. Speak into microphone.**

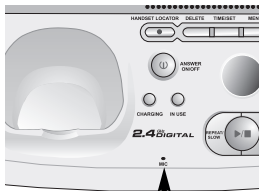

Microphone

**4. (Play/Stop)**

(Announcement is played back).

*Answering System Operation*

## Outgoing announcements

Outgoing announcements are the messages callers hear when calls are answered by the answering system.

The phone is pre-programmed with an announcement that answers calls with **"Hello. Please leave a message after the tone."** You can use this announcement, or replace it with a recording of your own voice.

### To record your outgoing announcement

Press **MENU** until you hear **"Change announcement."** Then press **RECORD** and begin speaking after you hear **"Now recording."** Speak facing the telephone base from about nine inches away. Press **PLAY/STOP** when you are done.

Elapsed time (in seconds) will be shown in the message window as you record. You can record an announcement up to 90 seconds long. Announcements less than three seconds long will not be recorded.

### To delete your outgoing announcement

Press **MENU** until you hear **"Change announcement,"** then press **PLAY/STOP** to begin playback. Press **DELETE** during playback to delete your announcement.

When your announcement is deleted, calls will be answered with the pre-programmed announcement described above.

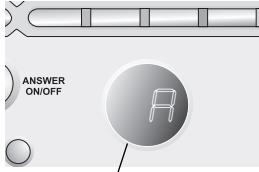

"A" is displayed when Announce Only is activated.

1. **MENU**  
 "Change Announce Only"
2. **CHANGE**  
 "Off"
3. **CHANGE**  
 "On"
4. (Play/Stop)  
**Beep**  
 (Option selected).

*Answering System Operation*

**Announce Only mode**

In announce only mode, callers hear an announcement but cannot leave messages. This option is useful, for example, to notify callers that you will be away for an extended period and request that they call back after a certain date.

**To turn Announce Only on or off**

Press **MENU** repeatedly until you hear "**Change announce only.**" Then press **CHANGE** until you hear the option you want (on or off). Press **PLAY/STOP** to store your selection and exit, or press **MENU** again to modify other features (see page 26).

**To record your outgoing announcement**

When announce only is turned on, calls are answered with a pre-recorded announcement that says "**We're sorry, messages to this number cannot be accepted.**" You can use this announcement, or replace it with a recording of your own voice.

After turning on the announce only feature, follow the steps on page 24 to record your announcement. Callers will hear this announcement only when the announce only feature is turned on. Otherwise they will hear the standard announcement asking them to leave a message.

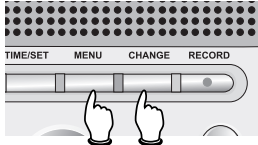

Answering System Operation

## Changing feature options

Menu features can be changed to customize how the answering system operates. Press **MENU** repeatedly to hear each feature. Press **CHANGE** when you hear the feature you want to modify.

**1. MENU**

Press until desired feature is heard (see list at right).

**2. CHANGE**

Press until desired selection is heard.

**3. MENU**

Press to set selection and **move** to next menu option.

**Or**



Press to set selection and **exit** menu.

**Feature options**

(Default settings underlined>)

System announces:	Feature description:
" <b>Change announcement</b> " Options: [record announcement]	Record your outgoing announcement (see page 24).
" <b>Change remote access code</b> " Options: [enter 2-digit code] <u>19</u>	Enter a two-digit number (10-99) for remote access from another phone (see page 30).
" <b>Change message alert</b> " Options: On / <u>Off</u>	When on, the telephone beeps every 10 seconds when you have new messages.
" <b>Change announce only</b> " Options: On / <u>Off</u>	When on, callers hear an announcement but cannot leave messages (see page 25).
" <b>Change base ringer</b> " Options: <u>On</u> / Off	Choose this option to turn the base ringer on or off (does not affect handset).
" <b>Change number of rings</b> " Options: 2 / <u>4</u> / 6 / Toll Saver	Choose number of rings before the system answers a call. When Toll Saver is active, the system answers after 2 rings if you have new messages, and after 4 rings if you have no new messages.



**NOTE:** Press and hold **CHANGE** to advance the remote access code number by 10.

Number of messages waiting (or, during playback, message number currently playing).

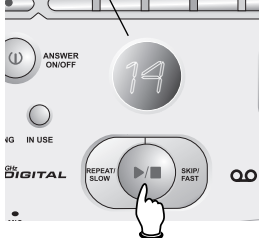

Press **PLAY/STOP** to begin or end message playback.

**1.** **(Play/Stop)**

**"You have [xx] new messages and [xx] old messages"**

Message playback begins. See options at right.

**2.** **(Play/Stop)**

Message playback ends.



**NOTE:** If "F" is flashing in the message window, memory is full. You will have to delete some messages before new ones can be received.



**NOTE:** New (unheard) messages cannot be deleted.

## Answering System Operation

### Message playback

Press **PLAY/STOP** to hear messages. The system announces the number of messages, then begins playback.

If you have new messages waiting, you will hear only the new messages (oldest first). If there are no new messages, the system will play back all messages (oldest first).

### Announcements

- When playback begins, you will hear the total number of messages.
- Before each message, you will hear the day and time it was received.
- After the last message, you will hear **"End of messages."** If the system has less than 5 minutes of recording time left, you will hear time remaining.

### Options during playback

- Press **VOLUME** button to adjust speaker volume.
- Press **SKIP** to skip to next message (or hold down to speed up message playback).
- Press **REPEAT** to repeat message currently playing. Press twice to hear previous message. (Hold down to slow message playback).
- Press **DELETE** to delete message being played back.
- Press **PLAY/STOP** to stop playback.

### To delete all messages

To delete all messages, press and hold **DELETE** while the phone is idle (not during a call, or during message playback).

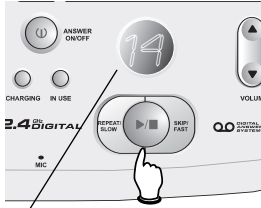

Elapsed recording time (seconds). Press to stop recording.

**1.** **RECORD**  
 "Now recording..."

**2.** Speak into microphone.

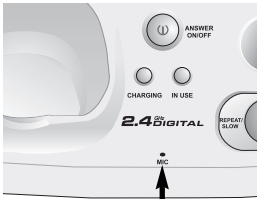

Microphone

**3.** **(Play/Stop)**  
 Beep (Memo has been recorded).

### Answering System Operation

## Recording and playing memos

Memos are messages you record yourself. They are saved, played back and deleted exactly like incoming messages. You can record a memo as a reminder to yourself, or leave a message for someone else if others in your household use the answering system.

### To record a memo

Follow the steps at left to record a memo. Elapsed time (in seconds) are shown in the message window as you record. You can record a memo up to 4 minutes long. Memos less than 1 second long will not be recorded.

### To play back a memo

Press **PLAY/STOP** to hear messages and memos (see page 27 for other options).

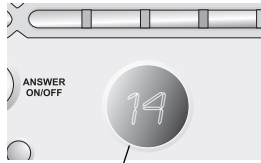

Message window

### Answering System Operation

## Message window displays

The message window usually displays the total number of memos and incoming messages. See the list below for explanations of other displays in this window.

### Message window displays

$\square$	No messages.
1-99	Number of messages/memos, or message number currently playing (flashes if you have new messages).
10-99	Current remote access code while setting (see page 26).
1-8	Current volume level while adjusting.
1-99 (counting)	Elapsed time while recording a memo (see page 28) or announcement up to 90 seconds (page 24).
99 (flashing)	Memo recording exceeded maximum time of 99 seconds.
F (flashing)	Memory is full. Messages must be deleted before new messages can be received.
CL (flashing)	Clock needs to be set (see page 23).
R	Announce only mode is on (see page 25).
--	System is answering a call, or being accessed remotely.
-- (flashing)	System is being programmed or initialized.
$\square n$ (or) $\square F$	Displayed for one second when any answering system setting is turned on or off.

1. Dial your telephone number from any touch-tone phone.
2. When system answers, enter two digit remote access code (19 unless you have changed it).
3. Enter remote commands (see list at right).
4. Hang up to end call and save all undeleted messages.

*Answering System Operation*

**Remote access**

A two digit security code is required to access your answering system from any touch-tone phone. This code is **19** by default; see page 26 to change it.

**Play messages**  
# 2

Press to hear new messages (if none are new, all play back).

**Repeat or go back**  
# 4

Press to repeat current message. Press twice (# 4 # 4) to hear previous message.

**Skip to next message**  
# 6

Press to skip current message and advance to next message.

**Stop**  
# 5

Press to stop any operation (stop playback, stop recording).

**Delete message**  
# 9

Press during playback to delete current message.

**Review announcement**  
# 7

Press to review current outgoing announcement.

**Record announcement**  
\* 7 to begin recording  
# 5 to stop recording

Press \* 7, wait for beep, then begin speaking. Press # 5 to stop recording and hear playback of new announcement.

**Record memo**  
\* 8 to begin recording  
# 5 to stop recording

Press \* 8, wait for beep, then begin speaking. Press # 5 to stop recording.

**Turn system off**  
# 0

Press to turn off answering system. Incoming calls will no longer be answered.

**Turn system on**  
# 0

If off, system will answer after 10 rings. Enter your access code, then press # 0 to turn on.

**Help Menu**  
# 1

Press to hear list of features & commands.

**Exit**  
\* 0

End remote access call (or hang up).

 **NOTE:** If you pause for more than 10 seconds during remote access, you will hear a help menu listing all features & commands. If you issue no command for another 20 seconds, the call will end automatically.





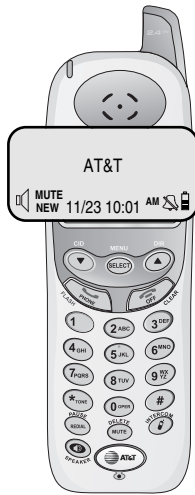

Appendix

## Screen icons, indicator lights & tones

### Handset screen icons & alert tones



#### Screen icons

-  Speakerphone in use.
-  Ringer off.
-  Battery charging (animated display).
-  Low battery (flashing); place handset in base or charger to recharge.
- MUTE** Microphone is muted.
- NEW** New calls (press **CID** to review call log).

#### Alert tones

- Happy tone** Programming command completed successfully.
- two beeps** Programming error (or last record in list displayed).

### Indicator lights

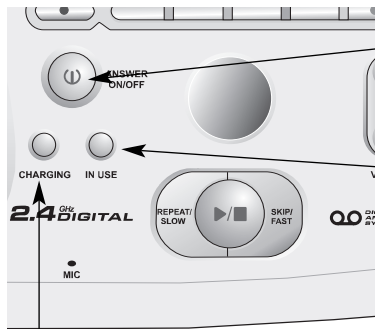

**Charging**  
On when handset battery is charging.

**Answer On/Off**  
On when answering system is activated and ready to receive calls.

**New Voice Mail**  
On when you have new voice mail.

**In Use**  
On when handset is in use. Flashes when another phone is in use on the same line, or answering system is answering an incoming call.

**Speaker**  
On when speakerphone is in use.



*Appendix*

## In case of difficulty

If you have difficulty with your phone, please try the suggestions below. For Customer Service, visit our web site at [www.telephones.att.com](http://www.telephones.att.com), or call 1-800-222-3111.

### Telephone does not work at all

- Make sure battery is installed and charged correctly (see page 7).
- Make sure the AC adapter is plugged into an outlet not controlled by a wall switch.
- Make sure the telephone line cord is plugged firmly into the base unit and the modular jack.
- If you have dial-pulse telephone service, make sure the dial mode is set to pulse (see page 15).
- If these suggestions do not work, unplug the base, remove and re-insert the battery, then place the handset in the base to re-initialize.

### Phone does not ring

- Make sure the ringer is on (see page 14).
- Make sure the telephone line cord and AC adapter are plugged in properly (see page 6).
- Move the handset closer to the base.
- You might have too many extension phones on your telephone line to allow all of them to ring. Try unplugging some of them.

### If you hear noise or interference during a call

- You may be out of range. Move closer to the base.
- Appliances plugged into the same circuit as the base can cause interference. Try moving the appliance or base to another outlet.
- The layout of your home or office might be limiting the operating range. Try moving the base to another location, preferably on an upper floor.
- If the buttons don't work, try placing the handset in the base for at least 15 seconds.
- Disconnect the base from the modular jack and plug in a corded telephone. If calls are still not clear, the problem is probably in your wiring or local service. Call your local telephone service company.

Appendix

## In case of difficulty

### Incomplete messages

- If a caller leaves a very long message, part of it may be lost when the system disconnects the call after 4 minutes.
- If the caller pauses for more than 7 seconds, the system stops recording and disconnects the call.
- If the system's memory becomes full during a message, the system stops recording and disconnects the call.

### Difficulty hearing messages

- Press  on the base to increase speaker volume.

### System does not answer after correct number of rings

- Make sure that the answering system is on.
- If Toll Saver is activated, the number of rings changes to 2 when you have new messages waiting (see page 26).
- In some cases, the system may be affected by the ringing system used by the local telephone company.
- If the memory is full or the system is off, the system will answer after 10 rings.

### "CL" flashes in message window

- You need to reset the answering system clock (see page 23).

### System does not respond to remote commands

- Make sure to enter your remote access code correctly (see page 30).
- Make sure you are calling from a touch-tone phone. When you dial a number, you should hear tones. If you hear clicks, the phone is not a touch-tone telephone and cannot activate the answering system.
- The answering system may not detect the remote access code while your announcement is playing. Try waiting until the announcement is over before entering the code.
- There may be noise or interference on the phone line you are using. Press dial-pad buttons firmly.

### Announcement message is not clear

- When you record your announcement, make sure you speak in a normal tone of voice, about nine inches from the base.
- Make sure there is no background noise (TV, music, etc.) while you are recording.

*Appendix***Technical specifications**

<b>RF Frequency Band (Handset to base)</b>	2400 MHz — 2485 MHz
<b>RF Frequency Band (Base to handset)</b>	2400 MHz — 2485 MHz
<b>Channels</b>	95
<b>Channel Spacing</b>	864 KHz
<b>Output Power</b>	20 dBm
<b>Sensitivity</b>	-96 dBm
<b>Modulation</b>	GFSK
<b>Operating Temperature</b>	32°F — 122°F 0°C — 50°C
<b>Base Unit Voltage (AC Voltage, 60Hz)</b>	96 — 130 Vrms
<b>Base Unit Voltage (AC Adapter Output)</b>	9VDC @600mA
<b>Handset Voltage</b>	3.2 — 4.7 VDC 600mAH

Appendix

## Index

### A

AC adapter, 6  
Alert tones, 31  
Answering calls, 10  
Answering system, 22-30

### B

Battery charging, 7  
Battery installation, 7  
Belt clip, 9

### C

Call Forward, 13  
Call Transfer, 13  
Caller ID, 20  
    add entries to phone directory, 21  
    delete entries, 21  
    dial entries, 21

CID, 20

### D

Delete Call Log entries, 21  
Delete redial entries, 10  
Dialing,  
    from a CID record, 21  
    phone book dialing, 19

### E

Elapsed time, 10  
Ending calls, 10

### F

Flash (switchhook flash), 11

### H

Hands-free use, 10  
Handset locator, 10  
Headset, 9

### I

Incoming call log, 20  
Incoming calls, answering, 10  
Indicator lights, 31

### L

Last number redial, 10

Low battery, 7

### M

Making calls, 10  
Menus, 2  
Messages, 22-30  
Mute, 11

### N

Names,  
    enter into phone book, 17  
    search for, 18

### O

Operating range, 5

### P

Phone book, 16  
    dial number, 19  
    edit entries, 19  
    name search, 18  
    new entries, 17

Problems, 32

### Q

Quick reference guide, 2-3

### R

Receiving calls, 10  
Recharging, 7  
Redial, 10  
Ring silencing, 11  
Ring tone options, 14

### S

Search for name, 18  
Speakerphone, 10  
Switchhook flash, 11

### T

Technical specifications, 34  
Troubleshooting, 32

### V

Volume controls, 11

Appendix

## Remote access wallet card

Use the wallet card below to help you remember commands to control your answering system from any touch tone telephone.

Cut along dotted line.



Call your phone number, then enter your 2-digit access code (preset to **19**).

**Action**

**Remote Command**

Voice help menu .....	#	1	
Play messages .....	#	2	
Repeat message .....	#	4	
Skip message .....	#	6	
Stop .....	#	5	
Save messages .....			Hang up.
Delete message .....	#	9	while message plays.

Fold here.

Review announcement .....	#	7	
Record announcement .....	*	7	Speak after beep.
	#	5	to stop.
Record memo .....	*	8	Speak after prompt.
	#	5	to stop.
End remote access call .....	*	0	(or hang up).
Turn system off .....	#	0	(enter again to turn on).
Turn system on .....			If off, system answers after 10 rings. Enter your access code, then press # 0 to turn system on.

**2.4 GHz Cordless Telephone/Answering System E2725B**

Copyright © 2004 Advanced American Telephones. All Rights Reserved.  
AT&T and the Globe Design are trademarks of AT&T Corp.,  
licensed to Advanced American Telephones. Printed in China.



[www.telephones.att.com](http://www.telephones.att.com)

Copyright © 2004 Advanced American Telephones. All Rights Reserved.  
AT&T and the Globe Design are trademarks of AT&T Corp.,  
licensed to Advanced American Telephones. Printed in China. Issue 3 AT&T 02/05.  
91-000153-031-000

## **CORDLESS Troubleshooting TAGS**

### **250 De-register and register**

De-register handset from the E2525, E2600B and E2555

Please take the Handset out of the Base before de-registering. Using the [SOFT] Keys on the Base, press MENU, then press the Down arrow twice until BASE SETTINGS is highlighted. Press OK, then press MUTE 3 times and FLASH twice. This will deregister the unit, please see more info to re-register.

Adding Handsets / Registering Handsets

Your telephone can accommodate up to 8 cordless Handsets. You can add new Handsets (Model E250, sold separately) at any time, but each must be registered with the Base before use.

Before using a new Handset, you must register it with the Base. There will be an R in the upper left hand corner of the display. The Display will read "ENTER BASE ID". Use the keypad on the Handset to enter Base ID. (To find this number, go to the Base, press [MENU], scroll down to select DISPLAY BASE ID, then press OK.) Once you have entered the Base ID number, press OK (middle key under the display). The unit will display "SEARCHING FOR BASE" and then "FOUND BASE". Your Handset will then be ready to use.

The Handset provided with your telephone is automatically registered as Handset 1. Additional Handsets will be assigned numbers in the order they are registered (2, 3, 4, etc.) up to a maximum of eight.

De-register 250 from the E2520 Base

Take the Handset out of the Base, press [\*] [\*] [3] [3] [5] [7] [8] [2] on the Base. This will de-register all of the Handsets at one time. See more information to register them again.

NOTE: The Base ID code is located on the bottom of the Base.

Adding new Handsets / registering the Handset

Your telephone can accommodate up to 8 cordless Handsets. You can add new Handsets (Model E250, sold separately) at any time, but each must be registered with the Base before use.

Before using a new Handset, you must register it with the Base. There will be an R in the upper left hand corner of the Display. The Display will read "ENTER BASE ID". Use the keypad on the Handset to enter the Base ID. (To find this number, go to the Base, on the bottom of the Base will be a white sticker that reads BS ID CODE. The code will start with a 36. Once you have entered the Base ID number, press OK (middle key under the display). The unit will display "SEARCHING FOR BASE" and then "FOUND BASE". Your Handset will then be ready to use.



The Handset provided with your telephone is automatically registered as Handset 1. Additional Handsets will be assigned numbers in the order they are registered (2, 3, 4, etc.) up to a maximum of eight.

## **Keypad Tone Feature - Vtech Telephones**

When the Keypad Tone Feature is ON but the handset is OFF (i.e. in standby):

You will hear loud tones being emitted through the external speaker on the back of the handset when you press any handset button except for the volume key.

When the Keypad Tone Feature is ON and the handset is ON (i.e. you pressed the [PHONE] button to make a call, you have dial tone and you are NOT on the Speakerphone):

1. You will hear the tones from the number buttons ([0] - [9]), the asterisk ([\*]), the pound ([#]), and the [SOUND SELECT] button ONLY through the earpiece on the handset (the receiver / internal speaker).

a) The earpiece on the handset (the receiver / internal speaker) is where you hear the dial tone. The above key tones will have the same approximate volume as the dial tone.

b) You WILL NOT hear these tones loudly through the external speaker on the back of the handset.

2. You will hear the loud tones from the [PHONE/FLASH] button, the [OFF] button, the [SOFTKEY] buttons (the 2 unnamed buttons under the display), and the [SPEAKER] button being emitted through the external speaker located on the back of the handset.

When the Keypad Tone Feature is OFF and the handset is OFF (i.e. in standby):

You will not hear any key tones from any handset buttons.

When the Keypad Tone Feature is OFF and the handset is ON (i.e. you have pressed the [PHONE] button to make a call, you have dial tone and you are NOT on the Speakerphone):

1. You WILL hear the tones from the number buttons ([0] - [9]), the asterisk ([\*]), the pound ([#]), and the [SOUND SELECT] button through the earpiece on the handset (the receiver/internal speaker). This is NORMAL operation.

a) The above key tones will have the same approximate volume as the dial tone.

b) You WILL NOT hear these tones being emitted through the external speaker located on the back of the handset.

c) You will not hear any tones from the [SOFTKEY] buttons (the two unnamed buttons under the display), or the [SPEAKER] button.

When the Keypad Tone Feature is OFF and the Speakerphone on the handset is ON:

1. You WILL hear the tones from the number buttons ([0] - [9]) emitted through the external speaker on the back of the handset.

a) When the speakerphone is on, this is also where you hear the dial tone emitted.

b) The above key tones will have the same approximate sound and volume as the dial tone.

2. You will not hear any tones from the [SOUND SELECT] button, the [SOFTKEY] buttons (the two unnamed buttons under the display), or the [SPEAKER] button.

When the Keypad Tone Feature is ON and the Speakerphone on the handset is ON:

1. You will hear the tones from the number buttons ([0] - [9]), the [SOFTKEY] buttons (the two unnamed buttons under the display), the [SPEAKER] button, the [PHONE]

button, and the [OFF] button emitted through the external speaker on the back of the handset.

2. You will not hear any tone when you press the [SOUND SELECT] button.

## **Keypad Tone Feature**

When the Keypad Tone Feature is ON but the handset is OFF (i.e. in standby):

You will hear loud tones being emitted through the external speaker on the back of the handset when you press any handset button except for the volume key.

When the Keypad Tone Feature is ON and the handset is ON (i.e. you pressed the [PHONE] button to make a call, you have dial tone and you are NOT on the Speakerphone):

1. You will hear the tones from the number buttons ([0] - [9]), the asterisk ([\*]), the pound ([#]), and the [SOUND SELECT] button ONLY through the earpiece on the handset (the receiver / internal speaker).

a) The earpiece on the handset (the receiver / internal speaker) is where you hear the dial tone. The above key tones will have the same approximate volume as the dial tone.

b) You WILL NOT hear these tones loudly through the external speaker on the back of the handset.

2. You will hear the loud tones from the [PHONE/FLASH] button, the [OFF] button, the [SOFTKEY] buttons ( the 3 unnamed buttons under the display), the [XFER/INTERCOM] button and the [SPEAKER] button being emitted through the external speaker located on the back of the handset.

When the Keypad Tone Feature is OFF and the handset is OFF (i.e. in standby):

You will not hear any key tones from any handset buttons.

When the Keypad Tone Feature is OFF and the handset is ON (i.e. you have pressed the [PHONE] button to make a call, you have dial tone and you are NOT on the Speakerphone):

1. You WILL hear the tones from the number buttons ([0] - [9]), the asterisk ([\*]), the pound ([#]), and the [SOUND SELECT] button through the earpiece on the handset (the receiver/internal speaker). This is NORMAL operation.

a) The above key tones will have the same approximate volume as the dial tone.

b) You WILL NOT hear these tones being emitted through the external speaker located on the back of the handset.

c) You will not hear any tones from the [SOFTKEY] buttons (the three unnamed buttons under the display), the [XFER/INTERCOM] button or the [SPEAKER] button.

When the Keypad Tone Feature is OFF and the Speakerphone on the handset is ON:

1. You WILL hear the tones from the number buttons ([0] - [9]) emitted through the external speaker on the back of the handset.

a) When the speakerphone is on, this is also where you hear the dial tone emitted.

b) The above key tones will have the same approximate sound and volume as the dial tone.

2. You will not hear any tones from the [SOUND SELECT] button, the [SOFTKEY] buttons (the three unnamed buttons under the display), the [XFER/INTERCOM] button, or the [SPEAKER] button.

When the Keypad Tone Feature is ON and the Speakerphone on the handset is ON:

1. You will hear the tones from the number buttons ([0] - [9]), the [SOFTKEY] buttons (the three unnamed buttons under the display), the [XFER/INTERCOM] button, the [SPEAKER] button, the [PHONE] button, and the [OFF] button emitted through the external speaker on the back of the handset.
2. You will not hear any tone when you press the [SOUND SELECT] button.

## **5860 Ringer On/Melody Selection**

Turn Ringer On

1. Press any [NavKey] button to get to the Handset Menu.
2. Press the left, right, up or down [NavKey] button to highlight Sounds and Alerts (handset with musical note icon), then press the center [NavKey] button to select.
3. Press the left, right, up or down [NavKey] to highlight Ringer Control (the bell icon), then press the center NavKey button to select.
4. Press the down [NavKey] button to highlight RINGER.
5. Press the left or right [NavKey] button to change the ringer status from Off to On.
6. Press the [SOFT] Key under SAVE.

Choose Ringer Melodies

1. Press any [NavKey] button to get to the Handset Menu.
2. Press the left, right, up or down [NavKey] button to highlight Sounds and Alerts (handset with musical note icon), then press the center [NavKey] button to select.
3. Press the left, right, up or down [NavKey] to highlight Ringers (the musical note icon), then press the center [NavKey] button to select.
4. Press the up or down [NavKey] button to highlight the different melodies. You will hear a sample of the melody you have highlighted.
5. Press the [SOFT] Key under SAVE when you have chosen the melody you want.

## **Adjust Ringer Volume**

1. Press any [NavKey] button to get to the Handset Menu.
2. Press the left, right, up or down [NavKey] button to highlight Sounds and Alerts (handset with musical note icon), then press the center [NavKey] button to select.
3. Press the left, right, up or down [NavKey] button to highlight RINGER CONTROL (the bell icon), then press the center button of the [NavKey] to select.
4. Press the left or right [NavKey] button to select the volume level. With each press of the button a sample of the volume is played.
5. Press the [SOFT] Key under SAVE.

To access the complete owner's manual. Click on the Red Top icon (located in the upper right hand corner of this page).

## **2256/1256 - 2325/2365 Replace**

This process is only to be used for the models 2256/1256, 2325, 2365 on the symptoms below:

- Every call customer hears pause in conversation, other end hears beeps.

·Every call conversation cuts in and out, other end hears beeps.

1. Advise the customer that you (the rep) will place a no charge replacement order that will be shipped via UPS service, which should arrive within 14 days. Advise the customer that they will also receive a prepaid ARS label sent via US Mail to return their original unit (no charge will be incurred by the customer).

2. The rep will be responsible for placing the order for the unit using the EXCHANGE-IW promo code in COPS and changing the shipping method to Free Shipping.

3. After placing the order, send an internal referral commitment to the [AAT ARS LABEL] team.

If you have any questions regarding this information, please see your supervisor. It is very important that every one understands this process and begins using it immediately.

NOTE: THE CUSTOMER MAY RECEIVE A 2256 FOR A 1256. THE TWO MODELS ARE IDENTICAL.

NOTE: THE CUSTOMER MAY RECEIVE A 2325 FOR A 2365. THE TWO MODELS ARE IDENTICAL.

## **T-Switch**

A standard hearing aid consists of a high gain amplifier between a microphone and receiver. If you put a cup over the ear such as a telephone handset, there is serious feedback and squealing. The remedy is to add a "T-Switch" in the hearing aid that disconnects the microphone and replaces it with a coil of wire. The phone receiver also has a coil of wire (HAC coil), and so these two coils form a transformer when they are in close proximity. Transformers transmit the signal magnetically rather than acoustically. The T-Coil in the hearing aid picks up any magnetic energy in close proximity. Spread spectrum phones produce a magnetic field when the RF transmitter turns on and off repeatedly. This magnetic energy can be picked up as static or hum in a hearing aid, but is usually a much lower level than the intended audio transmitted from the HAC coil. Generally, non-spread spectrum phones will perform better with hearing aids.

## **process for T2406 calls**

If the customer has had his or her unit longer than 45 days:

1. Advise the customer to mail his or her entire product to the San Antonio Returns Center using the normal in warranty repair shipping and return process.

2. Advise the customer that upon receiving his or her telephone product at our San Antonio Returns Center, he or she will receive a similar or upgraded replacement model within 3 business days.

If the customer has had his or her unit less than 45 days or refuses to pay shipping costs to return their product for in warranty service:

Do not send the customer back to the retailer. Offer to issue a replacement order and send a prepaid ARS label via US Mail for him or her to ship their original product back at no charge to them.

· If this is the case, it will be necessary for you to place an order for the VTech T2406 using the EXCHANGE-IW promo code in COPS and use regular standard shipping. (The customer will receive the replacement within 3-Business days.)

· After placing the order, send an internal referral commitment to the [VTECH ARS LABEL] team for a prepaid UPS ARS Label to be sent to the customer.

NOTE: DO NOT SEND THESE CUSTOMERS BACK TO THE RETAILER FOR REPLACEMENT (EVEN IF THEY ARE WITHIN THE FIRST 30 DAYS OF PURCHASE). IT IS IMPORTANT THAT YOU FOLLOW THIS PROCESS.

### **Process for gz2434 Calls**

If customers call with the one or more of the following symptoms: Static/Noise; Five Beeps; Call is Fading or Cutting In and Out; No Connect and the final resolution is repair, follow the below steps:

1. Advise the customer that you will place a no charge replacement order that will be shipped via express service, which should arrive within 1-3 business days. Advise the customer that they will also receive a prepaid UPS ARS label sent via US Mail to return their original unit (no charges will be incurred by the customer).

2. You will need to place a no charge replacement order for the VTech GZ2434 using the CSAT promotion code in COPS and change the shipping method to Free Shipping-Overnight (manager use only) \$0.

3. After placing the order, it will be necessary to send an internal referral commitment to the [VTECH ARS LABEL] team requesting an ARS label be sent to the customer.

If the customer is not satisfied with the express shipped replacement, offer to extend their manufacture's warranty for 6 months (this is different than a Protection Plan; Protection Plans should never be given out as a negotiation method).

### **Turning Message Light Off**

If the Message Light on the Base does not go off even after you've listened to voice mail messages:

1. Press [PROG/CHAN].

2. Press [>] until the screen displays: MESSAGES WAITING.

3. Press [SELECT]. The screen displays: LIGHTS OFF: YES.

4. Press [SELECT] again to turn off the Message Waiting Light on Base.

### **2600 De-Register**

2600 registered to a 2651

· In the idle mode, at the Base Unit keypad, press [\*] [\*] [3] [3] [5] [7] [8] [2].

2600 registered to a 2656 or 2670

· Unplug power from the Base.

· Hold down [PAGE] while reconnecting power. When the In Use Light blinks, release the [PAGE] key.

· Hold down [PAGE] for 5 seconds. When the In Use Light begins to flash, release the [PAGE] key.

· The Handset Charging Light will blink 5 times. Within 5 seconds from when it stops blinking, press [PAGE] once

Registration of the 2600

· After charging the Handset, remove it from its Charge Cradle. If the screen displays SEARCHING FOR BASE, Press NEW. If the screen displays ENTER BASE ID, go to step 2.

·Enter the 15 digit Base ID Code, located on the underside of the Base Unit. The ID Code can include numbers (0-9) and characters (\*,#).

·Press OK. The Handset will display: PLEASE WAIT!

·Wait approximately 15 seconds. The Handset will display FOUND BASE.

NOTE: Occasionally, it will take longer than 15 seconds for the Handset to find the Base Unit. This is normal.

If the Handset displays: BASE BUSY TRY LATER, this indicates that the system is in use. Wait until the Base Unit is in the idle (on hook) mode, and repeat steps 2 to 4.

## **Explanation of Why the TeleZapper Should Be Set On 'BASIC' to avoid interference with an Answering System**

Once the Answering System picks up the line, the TeleZapper also seizes the line and generates the tones which 'zap' telemarketers. When the TeleZapper is in 'advanced' mode, the tones can stay on the line long enough that the Answering System may think that an extension phone has been picked up (depending on the Answering System). If this happens, the Answering System's Call Intercept/Interrupt feature will stop the recording of the message, and since no extension has actually been picked up, the call will be disconnected.

## **Twisted Pair Cords**

Twisted pair cords are a type of phone cord wires used to reduce interference/crosstalk between lines. Twisted pair cords consist of two insulated copper wires which are twisted around each other to reduce interference from one wire to the other. The twisting of the wire pairs is what reduces the interference.

## **Dual-Band Frequency**

Our unit does utilize both the 5.8 and 2.4 GHz frequency bands simultaneously. The dual-band technology provides a clear advantage over existing cordless phones in its ability to avoid interference and provide optimal clarity in both received and transmitted audio.

Since transmitting in the 5.8 GHz frequency requires more power, the Base station transmits with the 5.8 GHz band (since it remains plugged to a power outlet all the time), while the battery-operated Handset transmits in the 2.4 GHz band, so it can yield optimum talk-time performance between battery charges.

## **Language Conversion**

VT5831 LANGUAGE CONVERSION OF HANDSET MENUS

ENGLISH

SPANISH

FRENCH

CALLS LOG

GUIA DE LLAMADAS

REGISTRE D'APPEL

INTERCOM

INTERCOMUNICADOR

INTERPHONE

HANDSET SETTINGS

CONFIG AURICULAR

REGLAGES COMBINE

SET TIME  
PONER TIEMPO  
REGLER L'HEURE  
CLOCK MODE  
MODO RELOJ  
MODE HORLOGE  
REGISTER  
REGISTRAR  
REGISTRE  
RINGER VOLUME  
TIMBRE VOLUMEN  
SONNERIE VOLUME  
RINGER MELODY  
TIPO DE TIMBRE  
SONNERIE MELODIE  
VIBRATE CONTROL  
CTRL VIBRACION  
MODE VIBRATION  
LOW BATT TONE  
TONO DE BAT BAJA  
SON PILE FAIBLE  
RANGE TONE  
TONO DE RANGO  
SON DE PORTEE  
KEYPAD TONE  
TONO DE DECLADO  
SON DU CLAVIER  
CONTRAST  
CONTRASTE  
CONTRASTE  
LANGUAGE  
IDIOMA  
LANGUE  
TO CHANGE HANDSET MENU FROM SPANISH:  
Press MENU.  
Scroll down to CONFIG AURICULAR. Press OK.  
Scroll down to IDIOMA. Press OK.  
Scroll up to INGLES (English) or scroll down to FRANCES (French). Press OK.  
TO CHANGE HANDSET MENU FROM FRENCH:  
Press MENU.  
Scroll down to REGLAGES COMBINE. Press OK.  
Scroll down to LANGUE. Press OK.  
Scroll up to ANGLAIS (English) or ESPAGNOLE (Spanish). Press OK.  
LANGUAGE CONVERSION OF BASE MENUS  
ENGLISH  
SPANISH

FRENCH  
CALLS LOG  
GUEA DE LLAMADAS  
REGISTRE D'APPEL  
BASE SETTINGS  
CONFIG BASE  
REGLAGES BASE  
DISPLAY BASE-ID  
NUMERO DE BASE  
NUMERO DE BASE  
RINGER VOLUME  
TIMBRE VOLUMEN  
SONNERIE VOLUME  
RINGER MELODY  
TIPO DE TIMBRE  
SONNERIE MELODIE  
KEYPAD TONE  
TONO DE DECLADO  
SON DU CLAVIER  
TONE/PULSE  
TONOS/PULSOS  
TONALITE/IMPUL  
CONTRAST  
CONTRASTE  
CONTRASTE  
LANGUAGE  
IDIOMA  
LANGUE

TO CHANGE BASE MENU FROM SPANISH:

Press MENU.

Scroll down to CONFIG BASE. Press OK.

Scroll down to IDIOMA. Press OK.

Scroll up to INGLES (English) or scroll down to FRANCES (French). Press OK.

TO CHANGE BASE MENU FROM FRENCH:

Press MENU.

Scroll down to REGLAGES BASE. Press OK.

Scroll down to LANGUE. Press OK.

Scroll up to ANGLAIS (English) or ESPAGNOL (Spanish). Press OK.

## **2461 De-register**

There are 2 different versions of this unit. If the customer has a tone/pulse switch on the bottom of the Base, please use one of the procedures for Mk1. If they do not have a tone/pulse switch on the bottom of the set, please use the procedure for Mk2a.

## **VT2461 Mk1 DEREGISTER ALL HANDSETS**

1. Unplug power from the Base. Remove spare battery pack.
2. Hold down [PAGE] while reconnecting power. When the POWER light begins to blink, release the [PAGE] key.



3. Hold down [PAGE] key for 5 seconds. When the LINE IN USE light begins to flash, release the [PAGE] key.

4. The HANDSET CHARGING light will blink 5 times. Within 5 seconds from when it stops blinking, press [PAGE] once.

### **VT2461 Mk1 DEREGISTER A SINGLE HANDSET**

1. Unplug power from the Base. Remove spare battery pack.

2. Hold down [PAGE] while reconnecting power. When the POWER light begins to blink, release the [PAGE] key.

3. Press [PAGE] 1 to 4 times, corresponding to the Handset you wish to deregister.

4. Once you complete step #3, the HANDSET CHARGING light will blink back to you the number of times corresponding to the Handset you wish to deregister. Within 5 seconds from when it stops blinking, press [PAGE] once.

### **VT2461 Mk2a**

1. Unplug power from the Base. Remove spare battery pack.

2. Hold down [PAGE] while reconnecting power. When the Base Display says 'Pr', release [PAGE].

3. Press [MENU]. The Display will say 'rh'.

4. Press [SELECT] to choose h1, h2, h3, h4 or AL (all).

5. Press [TIME/SET] to confirm.

Unplug power from the Base, then reconnect power to complete deregistration.

### **2455 De-register**

#### **DEREGISTER ALL HANDSETS**

1. Unplug power from the Base. Remove spare battery pack.

2. Hold down [PAGE] while reconnecting power. When the POWER light begins to blink, release the [PAGE] key.

3. Hold down [PAGE] for 5 seconds. When the LINE IN USE light begins to flash, release the [PAGE] key.

4. The HANDSET CHARGING light will blink 5 times. Within 5 seconds from when it stops blinking, press [PAGE] once.

### **DEREGISTER A SINGLE HANDSET**

1. Unplug power from the Base. Remove spare battery pack.

2. Hold down [PAGE] while reconnecting power. When the POWER light begins to blink, release the [PAGE] key.

3. Press [PAGE] 1 to 4 times, corresponding to the Handset you wish to deregister.

4. Once you complete step #3, the HANDSET CHARGING light will blink back to you the number of times corresponding to the Handset you wish to deregister. Within 5 seconds from when it stops blinking, press [PAGE] once.

### **8 inch 4 conductor line cord**

Perform the following:

-Advise the customer that we will send him a replacement 8 inch 4 conductor line cord.

-Inform the customer that he or she will receive the new replacement cord in U.S. Mail.

-Verify and update the customer's profile with all address and telephone information.

-Place an internal referral request via CRSS to Research Advisor to place an order for the replacement line cord.

Perform the following:

- Advise the customer that you are sending him or her a brand new replacement set (Cordless 2230 or 2255 whichever the customer has). If the customer does not want the replacement, advise him or her to return their unit to the place of purchase. Stop! If the customer accepts the replacement 2230/2255 continue....
- Inform the customer that he or she will receive the new replacement set(s) within 14 business days. Explain that you will also send an ARS label (via US Mail) for him or her to return his or her original unit.
- Verify and update the customer's profile with all address and telephone information.
- Access DES and enter a replacement order for the customer.
- You will then need to place another commitment (via the internal referral team [OSG-to place an SAP order]) requesting an ARS Label be sent to the customer.

## **Deregistration process for V2421**

- 1.If base is plugged in, disconnect the DC connector from it and wait at least 10 seconds before proceeding.
- 2.Hold down the [PAGE] button while reconnecting the DC cord to the base. Continue to hold down the [PAGE] button for 5 seconds after reconnecting power.
- 3.Release the [PAGE] button.
- 4.Press the [PAGE] button from 1 to 5 times, depending on the handsets you wish to deregister:
  - 1 press deletes HS1: 2 presses deletes HS2; etc. 5 presses deletes all.
 The Base LED will flash with each key press.
- 5.After entering the handset(s) to delete, the base will flash back the number of key presses entered.
- 6.Once the LED stops flashing, press [PAGE] once. Your mission is complete.

## **Access to SoundCard**

### Access to SoundCard

- 1.Press start
  - 2.Programs
  - 3.Accessories
  - 4.Entertainment/multimedia
  - 5.Volume control ( this will open the master volume control)
  - 6.Go to Options and select Properties
- Select Line In
- 1.Press start
  - 2.Programs
  - 3.Accessories
  - 4.Entertainment/multimedia
  - 5.Volume control ( this will open the master volume control)
  - 6.Go to Options and select Properties
  - 7.There will be an option to adjust Recording or playback volume control. Choose Recording.
  - 8.There is another section under recording where you pick which volume controls you want to show on the bar. Make sure there is a check next to "line". If there is not, please check it

9.Hit "Ok". Now "line or Line In" should show up in the master volume control for Recording. Please make sure that there is a check mark in the Select box under the "Line or Line IN

10.Go to Options and Select Properties.

11.There should be an option to adjust Recording or playback volume control. Choose Playback.

12.There is another section under playback where you pick which volume controls you want to show on the bar. Make sure there is a check next to "line or Line in". If there is not, please check it.

13.Hit "Ok". Now "line or Line in " should show up in the master volume control for Playback. Please make sure that there is a check mark in the MUTE box under the "line or line in". (it is possible that you may not have a MUTE option, it might be "SELECT". If you have a choice to SELECT then do not check SELECT under LINE")

14.Now close the Master Volume Control.

## **Operating Range General**

This cordless telephone operates within the maximum power allowed by the Federal Communications Commission (FCC). Even so, this handset and base can communicate over only a certain distance --- which can vary with the locations of the base and handset, the weather, and the construction of your home or office. For best performance, keep the base antenna fully upright.

If you receive a call while you are out of range, the handset might not ring --- or if it does ring, the call might not connect when you press [PHONE]. Move closer to the base, then press [PHONE] to answer the call.

If you move out of range during a phone conversation, you might hear noise or interference. To improve reception, move closer to the base.

If you move out range without pressing[OFF], your phone will be left "off the hook." To hang up properly, walk back into range, periodically pressing [OFF].

## **Handset De-Registration (2455/2461)**

1.Disconnect power to the Base (either unplug the DC connector from the bottom of the Base or unplug the power supply from the outlet). Remove spare battery, if applicable.

2.Hold down the base PAGE key while applying power back to the Base. When the POWER LED begins to blink, release the PAGE key.

THE USER HAS 15 SECONDS TO BEGIN THE NEXT STEP;OTHERWISE, THE BASE WILL EXIT PROGRAM MODE.

3.Hold down the PAGE key for 5 seconds. The HANDSET CHARGING LED will be lit, and after 5 seconds, the LINE IN USE LED will start to flash. Now release the PAGE key.

4.The HANDSET CHARGING LED will blink 5 times and then go out. Within 5 seconds from when it stops blinking, press and release the PAGE key.

All handsets should now be deregistered.

## **Conference calls**

When call is conferenced, two lines are being bridged through one telephone. The normal loss that occurs between a station to station call is doubled when using the conference call feature. The quality of transmission depends on many variables including the amount

of line voltage available at the phone and the distance of miles between the two other parties. Customer may consider 3-way calling service (if available through local telco) as alternative. Customer is less likely to experience volume loss due to more direct routing of conference.

### **Caller Id after 2<sup>nd</sup> ring**

Most Telco's send out the Caller ID information between the 1st and 2nd ring. Some Telco's send out this information later. If the machine answers the call before the information is received, the Caller ID information will be lost. Please set the number of rings to a number higher than 2. The customer may want to turn the machine off and then let a call come in to see when the information arrives. You need to set the answering system to answer the ring after the caller ID information arrives. Do not set it for the same ring. If you have voice mail service, set it to answer at 6 rings.

### **Operating Range 2.4**

This cordless operates in the 2.4 Gigahertz frequency band. Radio signals in this band can penetrate small openings and reflect around obstructions more efficiently than those of conventional cordless telephones. This allows the unit to operate in areas that are typically difficult for cordless phones.

Your cordless telephone operates at the maximum power allowed by the Federal Communications Commission (FCC). Even so, your handset and base can communicate only over a certain distance which can vary with the locations of the base and handset, the weather, and the construction of your home or office.

### **Spread Spectrum Echo**

This unit employs state-of-the-art frequency hopping spread spectrum (FHSS) technology to achieve one of the longest ranges in the consumer cordless telephone industry. FHSS is a digital technology that is also found in much more expensive cellular telephones. Just as it is common to experience echo in some cellular telephone systems, some users will experience occasional echo while using this phone. The presence and/or level of echo will depend on the electrical characteristics of the connection between the phone and user's local central office. This is normal operation. The customer can lower the volume on the handset and this will decrease the echo.

### **Caller ID/Call Waiting Services**

It may not be enough that the users subscribe to both services, they may also need to ask the local phone company to combine Caller ID with Call Waiting, so that their Caller ID product will be able to recognize names and numbers for a Call Waiting call, as well as, for regular calls. There may be an additional charge for this combined feature. Their phone company may use names for this combined feature that are not on this list, but listed below are some of the more generally used names for this combined Caller ID with Call Waiting service:

- Call Waiting ID, Caller ID/Call Waiting ID - Bell Atlantic
- Wait and See - Ameritech
- Call Waiting ID - PacBell, SW Bell
- Caller ID with Name on Call Waiting - SNET

in.

### **Operating Range 900**

This cordless operates in the 900 megahertz frequency band. Radio signals in this band can penetrate small openings and reflect around obstructions more efficiently than those of conventional cordless telephones. This allows the unit to operate in areas that are typically difficult for cordless phones.

Your cordless telephone operates at the maximum power allowed by the Federal Communications Commission (FCC). Even so, your handset and base can communicate only over a certain distance which can vary with the locations of the base and handset, the weather, and the construction of your home or office.

## **Cardiac Pacemakers**

THE FOLLOWING INFORMATION IS LOCATED AT THE BEGINNING OF THE CIB

Cardiac Pacemakers (applies only to 900 MHz Digital Cordless Telephones):

Preliminary studies performed at the U.S. Food and Drug Administration (FDA) and elsewhere have shown that when digital wireless telephones using technology similar to 900 MHz Cordless Telephones are placed very close to implanted cardiac pacemakers, interference with the operation of the pacemaker can occur. These preliminary studies show that interference is not likely to occur when there is a reasonable distance between the telephone and the implanted pacemaker and stops when the phone is set in the "battery save mode" or moved so that it is more than 3 inches from the pacemaker.

Based on these preliminary studies, the FDA has concluded that digital wireless telephones "do not seem to pose a significant problem for pacemaker wearers.

Until more is known, the FDA suggests that people with pacemakers may want to take some simple precautions when using or carrying digital wireless telephones to ensure that there is ample distance between the digital cellular telephone and the pacemaker -- by not placing the phone next to the pacemaker implant (for example, in a shirt or coat pocket directly over the pacemaker implant) when the phone is turned on ready to receive a call and holding it to the ear opposite the side of the body where the pacemaker is implanted when using the phone. Consult your physician or medical device manufacturer to determine if additional precautions are necessary.

## **Volume Controls**

Both the base unit and the handset have digital volume controls. The volume controls for the speakerphone are located on the front face of the base unit. Press the volume up side to increase the speaker volume and the volume down side to decrease the volume.

Holding either side down will continuously change the volume setting.

The volume controls for the handset are located on the side of the unit. Press the [^] (up) or [v] (down) keys to increase or decrease the volume.

## **Date Code Sticker**

The date code sticker can be found inside the handset battery compartment, on the bottom of the base, or on the pretty box. It specifically indicates where and when the product was manufactured.

Following is an example of what is shown on the sticker:

940101 B

2/7

CPS 2A

Note: If inputting the date code in the FCC field, use the following format:

940101B2-7CPS2A (CRS will not accept a slash.)

The battery save feature will deactivate the ring approximately 60 seconds after being set. After 60 seconds, the phone will enter "sleep mode". The phone will not ring or display "incoming call" when the extension phones are ringing. If any button on the phone is pressed, this will "wake up" the phone. If there is an incoming call within 60 seconds of a button being pressed, the phone will ring. Once nothing has been pressed for another 60 seconds, the phone will go back into "sleep mode" and will not ring.

## **ToneLength**

Tone length for most cordless telephones is 80-100 milliseconds.

Some services may require longer tones. You need to look for a phone that will continue to produce a tone signal for as long as a digit is held down. We have many phones with long tones.

## **Handset Warmth**

It is normal to feel heat near the battery compartment on the cordless handset once the battery has been fully charged. There is a component in the battery known as a "separator" which converts excess energy to heat.

## **Relocate Phone In Home EMI + Sep/Phns**

Interference generated by some radio equipment and electrical appliances and machinery may travel through the air, affecting other types of equipment in close proximity. Filters cannot help in this situation. Separating the objects may be the only solution.

### **CROSSTALK**

Split Line w/Triplex + Verify 2 cond cord on line 1

If single line telephone equipment is also experiencing crosstalk, the customer may try the following remedies:

1. Use shortest line cords possible.
2. Use 2 conductor line cords to connect all single line equipment.
3. Disconnect line 2 wires on any jack where not needed.

## **Crosstalk**

If crosstalk occurs while phones are plugged into the network interface, inside wiring is NOT the problem. Plug separate phones into the individual interfaces for each line.

Both lines will need to be in use at the same time to get valid test results.

## **TWO SINGLE LINE JACKS**

Verify that 2 conductor line cord is connected to L1/L2 port on telephone. 4 conductor cord may be used at L2 port.

## **SINGLE LINE TELEPHONE EQUIPMENT**

If single line telephone equipment is also experiencing crosstalk, customer may try the following remedies:

1. Use shortest line cords possible.
2. Use 2 conductor line cords to connect all single line equipment.
3. Disconnect line 2 wires on any jack where not needed.

## **TWO-LINE JACKS**

- Use triplex adapter and 2 line cords at each affected two-line set.
- Connect cords to L1 and L2 on adapter (not L1+L2) cannot use wall phones with triplex adapter.

Suggestions for reducing local telephone line recordings:

- If possible advise your callers to leave a message.
- Check with the local telephone company and advise them 7-10 seconds of silence is required for the answering system to disconnect.

NOTE: Charges may apply

### **Call Waiting disconnects answering system**

Answering System senses a fluctuation in line voltage caused by the Call Waiting signal and disconnects.

Contact Local Telephone Company for possible solutions.

### **External Antennas**

Additional external antennas are not recommended for the following reasons:

- AT&T cordless telephones are designed to ensure that the power output of the set does not exceed standards set by the FCC. The maximum power output allowed is .1 watt (or 100 milliwatts).
- Any attachment to a cordless telephone which increases the power output is in violation of FCC regulations.
- Once the product is opened in order to connect the external antenna, the warranty is voided.

### **Hearing Aid Compatibility**

This product is compatible with inductively coupled hearing aids.

Use of any other amplification devices near or on the cordless product may produce squealing, whistling, or feedback.

- If you use a hearing aid in only one ear, cradle the handset to the other ear to try to avoid microphone feedback.
- Remove or turn off the hearing aid when using the handset.
- Use a different extension telephone if you are unable to use the product without assistance of a hearing aid.

Information regarding inductively coupled hearing aids:

- This type of hearing aid is usually equipped with a T (telephone ) switch, specifically installed for improved amplification with telephone use.
- Flip the T switch to the telephone position to turn off the hearing aid microphone and turn on the inductive pickup coil that receives voice signals through a magnetic field generated by some telephone handset.
- Not all telephones generate a sufficiently strong magnetic field to couple to these hearing aids.
- Those that do are labelled Hearing Aid Compatible by AT&T.

### **Hearing Aid Compatibility**

This product is compatible with inductively coupled hearing aids.

### **Clean Charging Contacts**

- Each month clean handset and base charging contacts using a pencil eraser or a cloth to eliminate deposit accumulation.
- Charge light should come on when handset is cradled in base.
- Charge handset for 10 hours.

## **Calling in same Area Code**

Many LTCO's are changing their dialing sequence to 0 +, or 1 +, 10-digit dialing (0 + 0r 1 + area code + seven-digit phone number) for all long distance calls that are made within the same area code. All 0 +, or 1 +, 7-digit dialing within the same area code will be eliminated. This also means that local credit card and operator assistance calls that traditionally have been 0 + 7 dialed calls will now require 0 + 10 dialing. You will continue 0 + or 1 + 10 digit dialing for long distance calls into other area codes as you do today.

## **Recradle unplug AC**

- 1.Unplug the AC adapter from the wall outlet.
- 2.Remove battery cover on handset.
- 3.Unplug batteries from back of handset.
- 4.Wait 15 seconds and reinstall batteries securely.
- 5.Replace battery cover.
- 6.Recradle handset in base, replug AC adapter and wait 15 seconds.
- 7.Pick up handset and press phone.

NOTE: Be sure batteries have been charged recently.

## **Recradle unplug AC**

- 1.Unplug the AC adapter from the wall outlet.
- 2.Remove battery cover on handset.
- 3.Unplug batteries from back of handset.
- 4.Wait 15 seconds and reinstall batteries securely.
- 5.Replace battery cover.
- 6.Recradle handset in base, replug AC adapter and wait 15 seconds.
- 7.Pick up handset and press phone.

NOTE: Be sure batteries have been charged recently. If not, charge batteries fully for 16 Hours.

## **Handset Locked Up (Battery ) :**

- 1.Remove battery cover on handset.
  - 2.Unplug battery from back of handset.
  - 3.Wait 15 seconds.
  - 4.Reinstall battery securely.
  - 5.Replace battery cover.
  - 6.Recradle handset in base for 15 seconds.
  - 7.Pick up handset and press phone.
- NOTE: Be sure batteries have been charged recently.

## **Handset Locked Up (Battery ) :**

- 1.Remove battery cover on handset.
- 2.Unplug battery from back of handset.
- 3.Wait 15 seconds.
- 4.Reinstall battery securely.



5. Replace battery cover.
6. Recradle handset in base for 15 seconds.
7. Pick up handset and press phone.

NOTE: Be sure batteries have been charged recently. If not, charge batteries fully for 16 hours.

## **Common Cure**

If the unit does not seem to be responding normally, then try putting the handset in the base to reinitialize the unit. If it still does not seem to respond after doing this a few times, do the following (in the order listed):

1. Unplug the power cord.
2. Remove the handset battery.
3. Wait a few minutes.
4. Plug the power cord into an electrical outlet.
5. Install the handset battery.
6. Put the handset in the base to reinitialize.

## **Base Unit Locked Up:**

1. Recradle handset in base.
2. Unplug AC adapter from wall outlet.
3. Wait 15 seconds.
4. Reconnect AC adapter.
5. Wait 15 seconds.
6. Pick up handset and press PHONE button.

## **Single Audio Path Mutes**

Ringling from another line may briefly mute a conversation since this product is designed with a single audio path. This is a normal occurrence.

## **Chirping Sounds**

If chirping sounds are detected from the handset or base, check the following possible causes:

- Smoke detectors
- Other cordless telephones
- Alarm clocks

To enable the unit to work with business systems:

- Install the unit at the control box, or
- Wire a jack around the system.

NOTE: Unit will not have business system features if installed in this manner.

Check with the local telephone company to inquire as to possible low line voltage.

NOTE: The recommended voltage is 24 to 48 on hook.

Due to reduced line voltage, avoid having additional extension telephones "off the hook" during a call.

## **Wet Handset**

A handset dropped in water may still operate if left out to dry.

1. Empty any residual water.
2. Leave handset face down on a towel to dry for 72 hours.
3. If handset does not operate after 72 hours, send it in for repair.

To determine if telephones ring separately or together:

- 1.Remove telephones from line.
  - 2.Replace one at a time.
- Line 1 has a higher pitched ring that helps differentiate it from the ring of Line 2.
  - Have someone call on each line.
  - Let the telephone ring approximately five times and listen to the difference.
  - Try using 2 two conductor cords or purchase a 267C adapter.
  - Try a Triplex adapter and use a two cord connection.

## **Ringer Volume Not Adjustable**

Ringer volume cannot be adjusted.

If the volume is too loud, the ringer switch may be shut off.

NOTE: This will turn the ringer off completely and you will lose line lights.

## **4 Conductor Line Cord**

To determine if the unit's cord is four pin or two pin:

- Take another telephone "off the hook."
- Remove and inspect the telephone line cord.

## **Low Battery indicator**

The Low Battery indicator does not appear if:

- The unit is completely charged.
- The handset has completely discharged.

If the handset is normally kept in the base, the light should not appear.

Unplug excessive telephones or adjuncts or disconnect the telephones needed to bring ringer equivalence below total ringer equivalence.

Check with the local telephone company to inquire as to possible low line voltage.

NOTE: The recommended voltage is 24 to 48 on hook.

- Unplug both ends of the line cord.
- Plug in both ends of the line cord.
- Replace the line cord if the connections are loose.

## **Explain Call Waiting**

Explanation to Call Waiting customers:

- The unit picks up the first call after the preset number of rings.
- The second caller hears the telephone ring until the unit resets and is ready to answer the next call.
- There is no reset time.

## **More Than One Cordless**

If more than 1 cordless installed, have customer check to see if handsets are cradled on the correct base unit.

.

## **Ringer Equivalence**

On the bottom of each telephone or adjunct is a Ringer Equivalence.

1. Find this number for everything connected to your telephone line.
2. Add up all the numbers to get the total Ringer Equivalence.

## **Julian Date**

NOTE: Contact the telephone company, if required.

The Julian date for this unit is found on the bottom of the unit.

TAS units are manufactured in:

- Mexico (M)
- Taiwan (H)
- China (G)
- Thailand (L)

The Julian date (XX XXX X) is read as follows:

- The first two numbers (XX XXX X) represent the year (00 - 99) of manufacture.
- The next three numbers (XX XXX X) represent the day of the year (1 - 365) of manufacture.
- The last letter (XX XXX X) represent the place (M, H, G, L) of manufacture.

So, for example, 92291G was built in 1992, on the 291st day, in China.

When asked if a Julian date is after 92291G, 922209H, or 92168M, compare the Julian date the customer gives you with the Julian date above for the same manufacturing site.

For example, if the customer said, "93005G," you would compare it to 92291G and answer, "Yes."

## **Digital Voice**

The difference between the electronic and human voice:

The electronic voice is a digital reproduction of a human voice which is analog.