



at&t

User's manual

TL7812

DECT 6.0 cordless headset
and handset lifter



Congratulations

on your purchase of this AT&T product.

Unify your everyday business communications with the AT&T TL7812 DECT 6.0 Cordless Headset and Handset Lifter. Whether you want to connect directly to your corded telephone, telephone line or computer, you can with the TL7812 headset. Control costs and support your mobile workforce with connectivity to Voice over IP (VoIP) services like Skype™ and Microsoft Lync®. It comes with the TL7100 Handset Lifter, making it convenient to answer and end calls right from the headset. A magnetic charger in the cradle ensures the headset fits and charges securely—so you'll never run out of battery during long calls. With up to 12 hours of hands-free talk time and a range of up to 500 feet, you're free to work wherever your work is.

Before using this AT&T product, please read the **Important safety information** section on pages 59-61 of this manual. Please thoroughly read this user's manual for all the feature operations and troubleshooting information necessary to install and operate your new AT&T product. You can also visit our website at **www.telephones.att.com/smb** or call **1 (800) 222-3111**. In Canada, dial **1 (866) 288-4268**.

Visit **www.smbtelephones.att.com/compatibility-finder** for a complete list of AT&T phones that have been tested and found to be compatible with the TL7812.

Model number: TL7812

Type: DECT 6.0 cordless headset and handset lifter

Serial number: _____

Purchase date: _____

Place of purchase: _____

Both the model and serial numbers of your AT&T product can be found on the bottom of the headset base and lifter.

Save your sales receipt and original packaging in case it is necessary to return this product for warranty service.

© 2012 Advanced American Telephones. All Rights Reserved. AT&T and the AT&T logo are trademarks of AT&T Intellectual Property licensed to Advanced American Telephones, San Antonio, TX 78219. Printed in China. The Skype name is a trademark of Skype. Microsoft Lync is a registered trademark of Microsoft Corporation.

Parts checklist

Check to make sure the headset package includes the following items. Save your sales receipt and original packaging in the event warranty service is necessary.



Quick start guide



User's manual



Cordless headset with earbud attached



Headset base



Battery with battery compartment cover attached



Headset base power adapter



Telephone line cord



Corded phone connection cable



Line splitter

Parts checklist



Five earbuds



Two over the ear hooks



Over the head band



Behind the neck band



USB cable



Handset lifter



Large lifter pad



Anti-slip pad



Auxiliary ring detector

Optional accessory

This headset system can be expanded by registering a TL7800 accessory headset (sold separately) to it. The TL7800 includes an expansion headset and a headset charger (up to two headsets can be used with the same headset base).

For more information about the product, visit our website at [**www.telephones.att.com/smb**](http://www.telephones.att.com/smb)



TL7800

User's manual

TL7812

DECT 6.0 cordless headset
and handset lifter



Table of contents

Getting started

| | | | |
|---|----|---|----|
| Introduction..... | 1 | Option 3: Connect the headset to a telephone wall jack..... | 20 |
| Quick reference guide - headset..... | 2 | Adjust the corded handset audio..... | 21 |
| Headset lights..... | 2 | Attach the lifter..... | 22 |
| Headset alert tones..... | 4 | Adjust the switch hook presser position..... | 23 |
| Quick reference guide - headset base..... | 5 | Adjust the height of the lifter arm..... | 23 |
| Headset base lights..... | 5 | Lifter adjustments and testing..... | 24 |
| Quick reference guide - handset lifter..... | 8 | Installation of large lifter pad (optional)..... | 25 |
| STATUS light..... | 10 | Installation of anti-slip pad (optional)..... | 25 |
| Installation..... | 11 | About internal and auxiliary ring detectors..... | 26 |
| Colored labels..... | 11 | Install the auxiliary ring detector..... | 26 |
| Digital subscriber line (DSL).... | 11 | Ring detector on/off..... | 27 |
| Battery installation..... | 12 | Adjust the sensitivity level..... | 27 |
| Headset base installation and battery charging..... | 13 | Headset attachments..... | 28 |
| Headset base and handset lifter installation..... | 14 | Earbud..... | 28 |
| Installation options..... | 14 | Over the ear hook..... | 29 |
| Option 1: Connect the headset to a corded phone..... | 15 | Over the head band..... | 32 |
| Option 2: Connect the headset to a corded phone and computer..... | 17 | Behind the neck band..... | 34 |

Operation

| | |
|---|----|
| Headset operation | 37 |
| Power on/off the headset..... | 37 |
| PHONE mode and PC mode..... | 37 |
| PHONE mode..... | 38 |
| Make a call..... | 38 |
| Answer a call..... | 38 |
| End a call..... | 39 |
| Headset ringer | 39 |
| Temporary ringer silencing..... | 40 |
| Call waiting..... | 40 |
| Options while on calls..... | 41 |
| Volume control..... | 41 |
| Mute | 42 |
| Multiple headsets use | 42 |
| Switching between PHONE mode and PC mode..... | 43 |
| Adding and registering headsets | 44 |
| Register a headset to the headset base | 45 |
| Deregistering headsets..... | 46 |
| Deregister all headsets from the headset base | 46 |

Appendix

| | |
|--|----|
| Troubleshooting | 47 |
| Maintenance..... | 58 |
| Important safety information..... | 59 |
| Safety information..... | 59 |
| Especially about cordless headsets | 60 |

| | |
|--|----|
| Precautions for users of implanted cardiac pacemakers..... | 61 |
| Pacemaker patients..... | 61 |
| FCC Part 68 and ACTA..... | 62 |
| FCC Part 15..... | 64 |
| Limited warranty..... | 65 |
| Technical specifications | 68 |
| DECT 6.0 digital technology..... | 68 |
| Operating range..... | 68 |
| Extended range and clarity | 68 |
| Encrypted for added security..... | 68 |

Index

| | |
|------------|----|
| Index..... | 69 |
|------------|----|

Introduction

The TL7812 is a cordless headset and base that allows you to have handsfree phone conversations. The package also comes with the TL7100 handset lifter, making it convenient to answer and end calls right from the headset. It can be used in different ways depending on your needs. Choose from the following three options. Connect your TL7812:

- **To a traditional corded telephone** (pages 15-16). Connect the headset base to a corded telephone and install the lifter on your corded telephone. You can use the headset to remotely control the lifter for answering or hanging up a call.
- **To both a corded phone and computer** (pages 17-19). Connect the headset base to a corded telephone and install the lifter on your corded telephone. Use the USB cable to connect the headset base and your PC. You can make and answer VoIP calls through Skype or Microsoft Lync, or landline calls using the **AT&T Softphone Call Manager**.

Visit **www.smbtelephones.att.com/downloads** to download the **AT&T Softphone Call Manager**. For installation and operation instructions of the software, refer to the Installation and Operation Guide which can also be downloaded at **www.smbtelephones.att.com/downloads**.

- **To a telephone line only** (page 20). If you do not want to install the lifter on the corded handset, you can simply connect the headset to a telephone wall jack through the line splitter provided. Use the telephones on the same telephone line to make or answer calls. The headset is a supplementary device that can join the calls.

Quick reference guide - headset



(On/off button and light)

Press to make, answer or end a call (pages 38-39).

Headset lights

|  light status | |
|--|--|
| Red | <ul style="list-style-type: none"> • On when the headset is charging in the headset base. • Flashes every 10 seconds to indicate the battery is low when the headset is not in the headset base. • Flashes three times to indicate the headset is powering off. |
| Blue | <ul style="list-style-type: none"> • On when a fully charged and registered headset is in the headset base. • Flashes three times to indicate the headset is powering on. • Flashes twice every three seconds when the headset is in use. • Flashes four times every four seconds when there is an incoming call in PHONE mode. • Flashes every 10 seconds when a fully charged and registered headset in idle mode is out of the headset base. |
| Red and blue | <ul style="list-style-type: none"> • Flashes slowly when the headset is not registered. • Flashes quickly when the headset is trying to register to a headset base. |
| Off | <ul style="list-style-type: none"> • The battery is dead. • No battery is installed. • The headset is powered off. |

Quick reference guide - headset

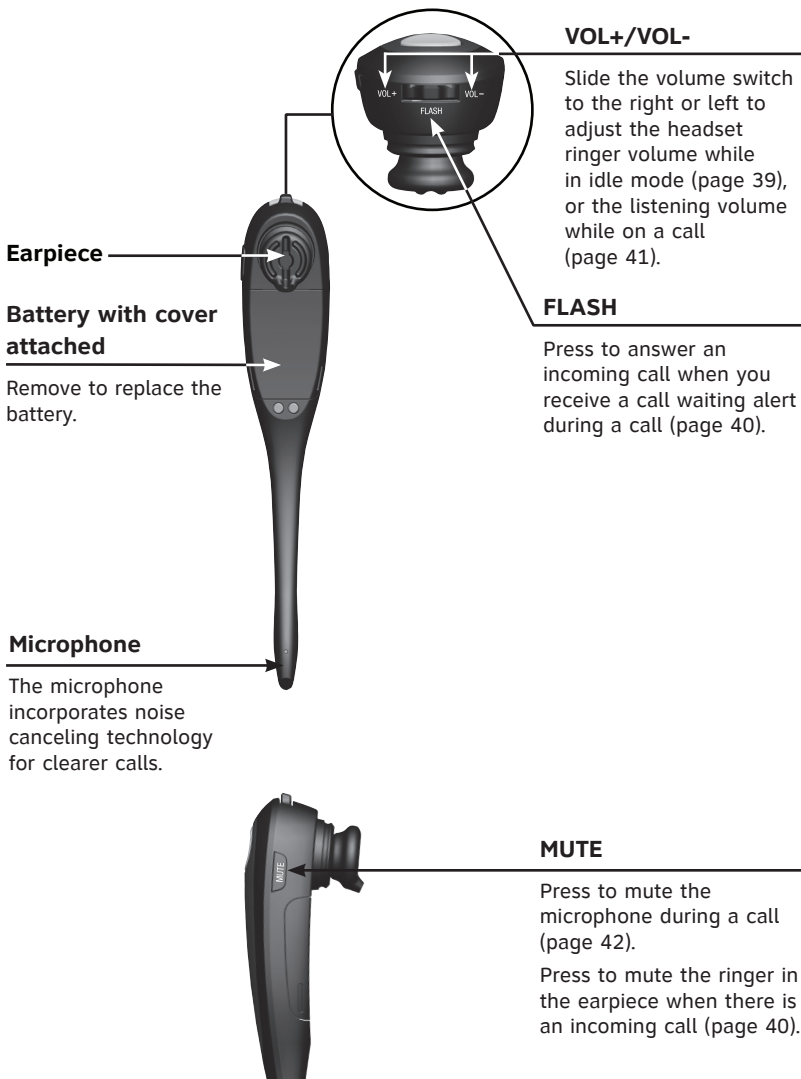

Quick reference guide - headset

Headset alert tones

| | |
|------------------------------------|--|
| One short beep every 30 seconds | <ul style="list-style-type: none">• The microphone is muted. |
| Two beeps | <ul style="list-style-type: none">• Error alert tone.• The ringer volume has reached its lowest setting.• The listening volume has reached its highest or lowest setting.• The speaking volume has reached its highest or lowest setting.• Any key is pressed while the headset is out of range. |
| Two low beeps | <ul style="list-style-type: none">• Call waiting alert tone. |
| Two rapid beeps every 20 seconds | <ul style="list-style-type: none">• Low battery warning. |
| Three rising beeps | <ul style="list-style-type: none">• A conference call has started. |
| Three rapid beeps every 20 seconds | <ul style="list-style-type: none">• The headset is out of range.• The headset is not yet registered. |
| Three rapid beeps | <ul style="list-style-type: none">• The headset is powering on or off. |

Quick reference guide - headset base

Magnetic charging mount

Place the headset here for charging.

MUTE (light)

PHONE (mode button and light)

PAIR

Use to initiate headset registration or deregistration.

PC (mode button and light)

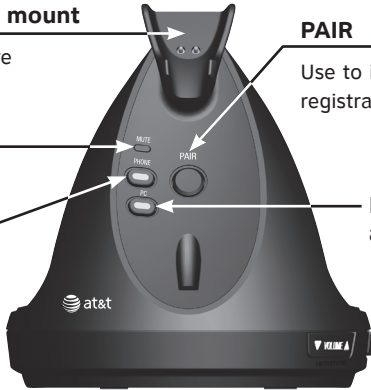

Headset base lights

| | |
|---------------------|---|
| MUTE (Red) | <ul style="list-style-type: none">• On when you are registering a headset.• Flashes when a call is muted.• Flashes when you are deregistering headset(s) from the headset base. |
| PHONE (Blue) | <ul style="list-style-type: none">• On when PHONE mode is selected as the default mode on the idle headset base.• Flashes four times every four seconds when there is an incoming call.• Flashes twice every three seconds when the headset is in use in PHONE mode.• Flashes slowly when a call is on hold in PHONE mode. |
| PC (Blue) | <ul style="list-style-type: none">• On when PC mode is selected as the default mode on the idle headset base.• Flashes twice every three seconds when the headset is in use in PC mode.• Flashes slowly when a call is on hold in PC mode. |

Quick reference guide - headset base

▼ VOLUME ▲/MICROPHONE

Press the volume keys on the side of the headset base to adjust the speaking volume when on a call (page 41).

🔌 (USB port)

Open the port cover to plug in the USB cable for use with PC mode (pages 17-18).

LIFTER

This jack is only used to connect an AT&T handset lifter (model TL7100, purchased separately).

CORDED HANDSET CONNECTED/ YES/NO

Choose the setting based on whether you have connected to a corded handset (page 16, 18 or 20).



Quick reference guide - headset base



CORDED PHONE CONNECTION jack (blue dot)

This jack is only used to connect the corded phone connection cable (page 15 or 17).

TEL WALL JACK (red dot)

POWER jack (green dot)

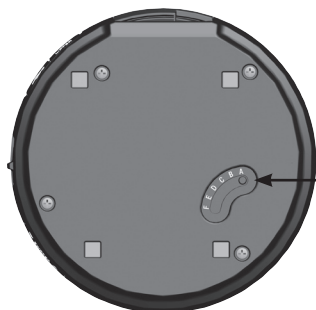

Corded handset audio adjust switch

Use this switch to adjust the corded handset audio when you have connected the headset base to a corded telephone (page 21).

Quick reference guide - handset lifter

SENSOR ADJ knob

Adjusts the sensitivity of the ring detector (page 27).

ADJUST LIFTER knob

Adjusts the height of the lifter arm (page 23).

Lifter arm

Holds the corded telephone handset.

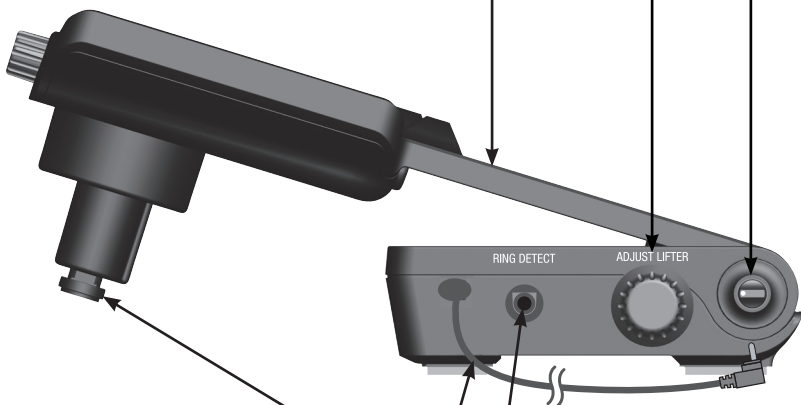

Switch hook presser

When the **CORDED HANDSET CONNECTED** switch is set to **YES**, pressing  on the headset raises or lowers the switch hook presser.

Lifter control cable

Plug this cable into the **LIFTER** jack on the headset base.

RING DETECT jack

Plug in the auxiliary ring detector (page 26).

Quick reference guide - handset lifter

RING ON/OFF

Press to turn the ring detector on or off. When the ring detector is off, the cordless headset does not ring (page 27).

Switch hook presser adjustment knob

Adjusts the position of the switch hook presser (page 23).

Small lifter pad

Holds the earpiece of the corded telephone handset.

STATUS light

On in red when the ring detector is off (page 10).

On in blue when the ring detector is on and the headset is not in use (page 10).

Flashes in blue four times every three seconds when the ring detector detects an incoming call (page 10).

Flashes in blue slowly when the switch hook presser is raised and you are on a call (page 10).

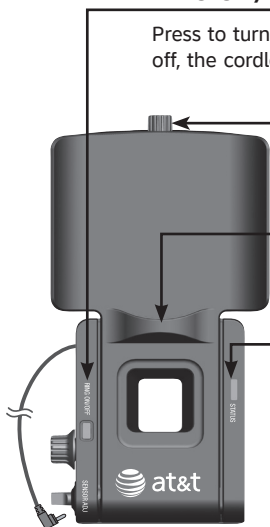

Front view

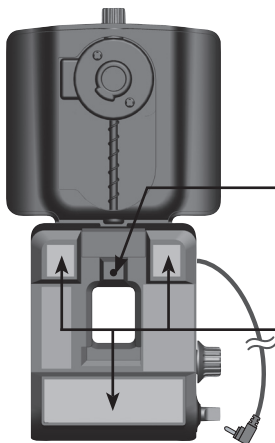

Back view

Internal ring detector

Detects the telephone ringer and sends a ring tone to the headset earpiece.

Adhesive tape

Remove the protective strips before attaching the lifter to the telephone base.

Quick reference guide - handset lifter

STATUS light

| | |
|------|---|
| Red | <ul style="list-style-type: none">• On when the headset is not in use and the ring detector is turned off.• Flashes slowly when the headset is in use and the ring detector is turned off. |
| Blue | <ul style="list-style-type: none">• On when the headset is not in use and the ring detector is turned on.• Flashes four times every three seconds when the ring detector detects an incoming call.• Flashes slowly when the headset is in use and the ring detector is turned on. |
| Off | <ul style="list-style-type: none">• The headset base does not have power.• The lifter control cable is not plugged into the LIFTER jack on the headset base. |

You must install and charge the battery before using the headset.

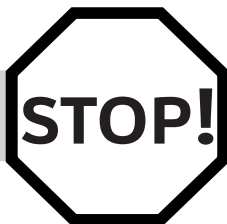

See pages 12-13 for easy instructions.

Colored labels

The cords have colored labels that guide you to plug them into the correct headset base jacks. The back of the headset base has color-coded dots and the names of the jacks above them that correspond to the colored labels on the cords.

Digital subscriber line (DSL)

If you subscribe to high-speed Internet service (DSL - digital subscriber line) through your telephone line, you must install a DSL filter between the telephone line cord and telephone wall jack (see page 15, 17 or 20). The filter prevents noise and caller ID problems caused by DSL interference. Please contact your DSL service provider for more information about DSL filters.

For customer service or product information, visit our website at **www.telephones.att.com/smb** or call **1 (800) 222-3111**. In Canada, dial **1 (866) 288-4268**.

Avoid placing the headset base too close to:

- Communication devices such as television sets, VCRs or other cordless telephones.
- Excessive heat sources.
- Noise sources such as a window with traffic outside, motors, microwave ovens, refrigerators or fluorescent lighting.
- Excessive dust sources such as a workshop or garage.
- Excessive moisture.
- Extremely low temperature.
- Mechanical vibration or shock such as on top of a washing machine or work bench.

Battery installation

The battery is permanently attached to the battery compartment cover. Do not try to separate them from each other. After installing the battery pack, charge it for at least 15 minutes. You may be able to make and receive short calls. For optimal performance, charge the headset battery for at least three hours before use. When fully charged, the headset battery provides approximately 12 hours of talk time or 5 days of standby time. When the headset is not in use, recharge by returning it to the headset base.

1. Insert the battery pack into the battery compartment.

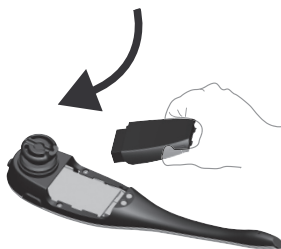

2. Press down on the battery pack until it clicks into place.

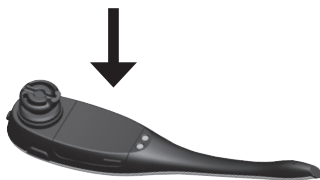

NOTES:

- Remove any headset attachment (earbud excluded) before battery replacement.
- To order a replacement battery pack (model BT191665), visit our website at **www.telephones.att.com/smb** or call **1 (800) 222-3111**. In Canada, dial **1 (866) 288-4268**.

Headset base installation and battery charging

After installing the battery, charge the headset by placing it in the magnetic charging mount as shown below. The Φ light turns on when the headset is charging.

1. Plug the small end of the headset base power adapter into the **POWER** jack (green dot) at the back of the headset base. Plug the large end into an electrical outlet not controlled by a wall switch.



2. Insert the headset into the magnetic charging mount.



3. The magnet holds the top of the headset in place. The Φ light turns on.



IMPORTANT INFORMATION

Use only the supplied rechargeable battery pack or replacement battery pack (model BT191665). To order, visit our website at

www.telephones.att.com/smb or call

1 (800) 222-3111. In Canada, dial **1 (866) 288-4268.**

Headset base and handset lifter installation

Installation options

There are three installation options as described below.

For Options 1 and 2, the handset lifter works with the cordless headset to provide a complete communication solution for most corded telephones. The lifter raises and lowers its switch hook presser to answer, make and end phone calls. The ring detector provides an incoming call indication through the cordless headset, so you can answer calls even when you are away from the telephone base.

Option 1: Connect the headset to a corded phone (see pages 15-16). This option allows you to use the headset to remotely control the lifter for answering or hanging up a call.

Option 2: Connect the headset to a corded phone and computer (see pages 17-19). This option enables you to use the headset for VoIP (Voice over IP) calls through your computer, or traditional phone call through the corded phone.

Option 3: If you do not want to install the lifter on the corded handset, you can simply connect the headset to a telephone wall jack through the line splitter provided (see page 20). The headset acts as a supplementary device that can join calls. Use the telephones connected to the same telephone line to make or answer calls.

Headset base and handset lifter installation

Option 1: Connect the headset to a corded phone

1. Plug one end of the corded phone connection cable into the **CORDED PHONE CONNECTION** jack (blue dot) at the back of the headset base.
2. Plug the other end of the corded phone connection cable into the handset jack on the corded phone.
3. Unplug the curly handset cord from the handset jack on the corded phone and plug it into the jack on the corded phone connection cable.
4. Plug the small end of the headset base power adapter to the **POWER** jack (green dot) on the headset base.

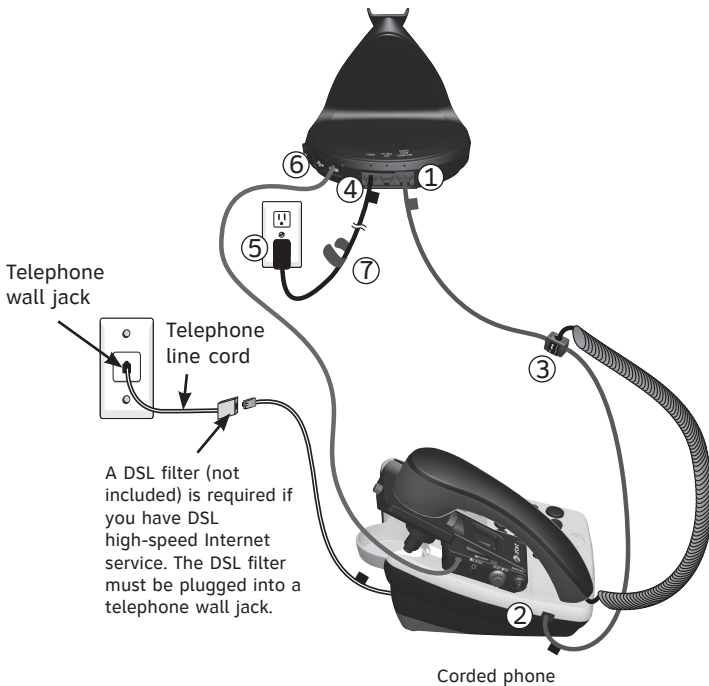

Headset base and handset lifter installation

Option 1: Connect the headset to a corded phone (cont.)

5. Plug the large end of the headset base power adapter into a power outlet not controlled by a wall switch.
6. Plug the end of the lifter control cable into the **LIFTER** jack at the back of the headset base.
7. Use the attached fastener to bundle all line cords neatly.
8. Make sure the **CORDED HANDSET CONNECTED** switch on the right side of the headset base is set to **YES**.
9. Adjust the corded handset audio (see page 21) before you install the handset lifter on the corded phone.
10. For instructions of installing the lifter, see pages 22-25. For information about the internal and auxiliary ring detectors, refer to pages 26-27.



Headset base and handset lifter installation

Option 2: Connect the headset to a corded phone and computer

1. Plug one end of the corded phone connection cable into the **CORDED PHONE CONNECTION** jack (blue dot) at the back of the headset base.
2. Plug the other end of the corded phone connection cable into the handset jack on the corded phone.
3. Unplug the curly handset cord from the handset jack on the corded phone and plug it into the jack on the corded phone connection cable.

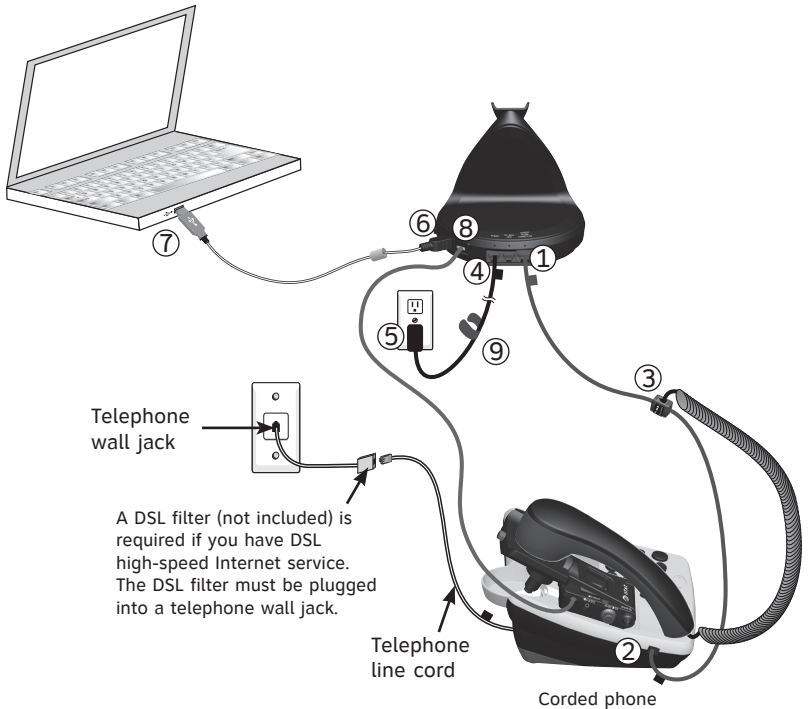

Headset base and handset lifter installation

Option 2: Connect the headset to a corded phone and computer (cont.)

4. Plug the small end of the headset base power adapter to the **POWER** jack (green dot) on the headset base.
5. Plug the large end of the headset base power adapter into a power outlet not controlled by a wall switch.
6. Plug the small end of the USB cable into the USB port labeled  on the right side of the headset base.
7. Plug the large end of the USB cable into a USB port on your computer. Wait for your computer to indicate that it has recognized the headset.
8. Plug the end of the lifter control cable into the **LIFTER** jack at the back of the headset base.
9. Use the attached fastener to bundle all line cords neatly.
10. Make sure the **CORDED HANDSET CONNECTED** switch on the right side of the headset base is set to **YES**.
11. Adjust the corded handset audio (see page 21) before you install the handset lifter on the corded phone.
12. For instructions of installing the lifter, see pages 22-25. For information about the internal and auxiliary ring detectors, refer to pages 26-27.
13. Download and install the **AT&T Softphone Call Manager** on your computer. The software is available for download at www.smbtelephones.att.com/downloads. For detailed installation and operating information, refer to the **Installation and Operation Guide for AT&T Softphone Call Manager**, available for download at www.smbtelephones.att.com/downloads.



Headset base and handset lifter installation

Option 2: Connect the headset to a corded phone and computer (cont.)

14. After you have installed the **AT&T Softphone Call Manager**, check to make sure the audio setting is properly configured in your Windows system. If you have installed Skype and/or Microsoft Lync and want to use them with your headset, make sure the audio settings are configured correctly in the programs as well.

a) Audio settings in Windows system:

- i. Launch the **AT&T Softphone Call Manager** program.
- ii. Click on the **Settings** panel, then the **General** panel.
- iii. Click on [**Click to launch audio devices control panel**].
- iv. Make sure **AT&T DECT Headset** is selected under the playback and recording settings in your Windows system.

b) Audio settings in Skype:

- i. Launch the Skype program.
- ii. Click on **Tools**, then **Options**.
- iii. Click on **Audio settings**.
- iv. Make sure **AT&T DECT Headset** is selected under the speakers and microphone settings.

c) Audio settings in Microsoft Lync:

- i. Launch the Microsoft Lync program.
- ii. Click on **Options**, then **Audio device**.
- iii. Make sure **AT&T DECT Headset** is selected under the Audio device setting.



IMPORTANT

Periodically check for software updates. Go to the **Support** panel in the **AT&T Softphone Call Manager**, then click on **Check now**. For more details, refer to the **Installation and Operation Guide for AT&T Softphone Call Manager**.

Headset base and handset lifter installation

Option 3: Connect the headset to a telephone wall jack

1. Make sure the **CORDED HANDSET CONNECTED** switch on the right side of the headset base is set to **NO**.
2. Connect the line cords as shown below. Use the included line splitter to connect the headset base and your telephone to the same telephone wall jack.



- Plug one end of the telephone line cord into the **TEL WALL JACK** (red dot) at the back of the headset base.



- Use the attached fastener to bundle all line cords neatly.



- Connect another telephone line cord between the telephone and the line splitter.



Corded or cordless phone

Telephone line cord

- Plug the other end of the telephone line cord into the line splitter.

- Plug the line splitter into the telephone wall jack (or a DSL filter if you subscribe to DSL Internet service).

Line splitter



A DSL filter (not included) is required if you have DSL high-speed Internet service. The DSL filter must be plugged into a telephone wall jack.



NOTE: The headset base and headset do not have external ringers. When you receive calls, the headset earpiece rings. If you have telephones connected to the same telephone line as the headset base, you can rely on the ringers of those telephones to alert you to incoming calls.

Headset base and handset lifter installation

Adjust the corded handset audio

After you have connected the headset base to your corded phone, you may need to adjust the corded handset audio switch at the bottom of the headset base for optimal sound quality.

To adjust the corded handset audio:

- Lift the corded handset and then press  on the headset to check for a dial tone. If there is no dial tone or the dial tone is unclear, slide the corded handset audio switch at the bottom of the headset base from **A** to **F** until the dial tone is clear.

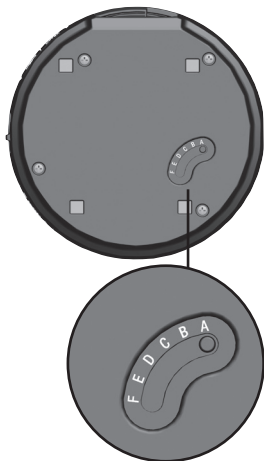

Headset base and handset lifter installation

Attach the lifter

1. To choose where to install the lifter on your telephone, look at the space underneath the corded handset. If there is a speaker, the lifter should be centered over the speaker. If there is no speaker, the lifter should be centered within the space. Make sure the lifter arm is raised above the switch hook of the telephone base.
2. Peel off the protective strips from the adhesive tape at the bottom of the lifter.
3. Carefully place the lifter in the desired position and press down.
4. Plug the lifter control cable into the **LIFTER** jack on the headset base.

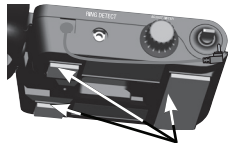

Adhesive tape

Headset base and handset lifter installation

Adjust the switch hook presser position

Turn the knob to move the switch hook presser until it is lined up with your telephone switch hook.

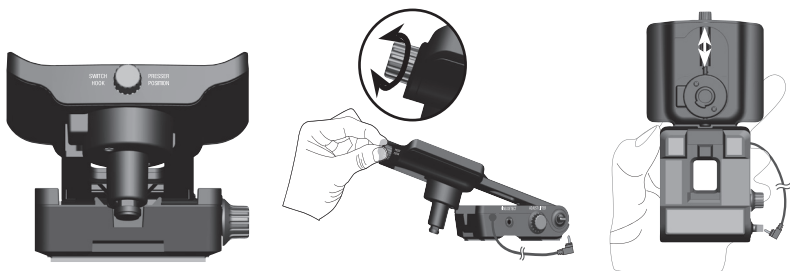

Adjust the height of the lifter arm

Turn the **ADJUST LIFTER** knob to change the height of the lifter arm. When in the raised position, the arm should release the switch hook so you can hear a dial tone. When lowered, the arm should hold the switch hook down so you cannot hear a dial tone.

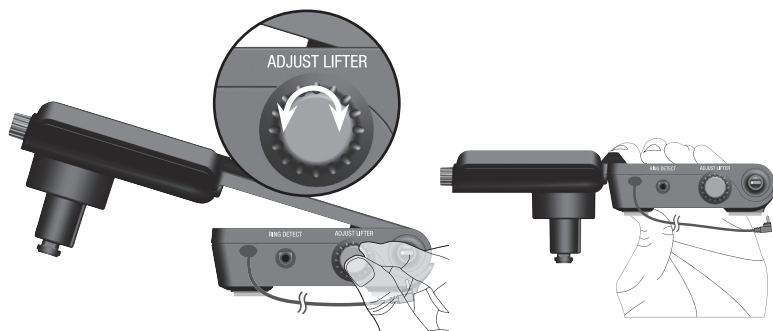

Headset base and handset lifter installation

Lifter adjustments and testing

1. Make sure that the **CORDED HANDSET CONNECTED** switch on the headset base is set to **YES**.
2. Turn the switch hook presser adjustment knob until the switch hook presser is just above the switch hook (see page 23).
3. Lower the lifter arm until the switch hook presser holds the switch hook down.
4. Place the corded handset on the lifter.
5. Press **⏻** on the headset. The switch hook presser should rise and release the switch hook on your telephone base. Make sure you hear a dial tone through your headset earpiece.
6. If the switch hook is not fully released, turn the **ADJUST LIFTER** knob (see page 23) while the corded handset is on the lifter. When the switch hook is fully released, you will hear a dial tone from the headset.



It may take some adjustments and testing to find the right position for the lifter. For the lifter to work properly, the switch hook must release completely when you press **⏻** and turn the headset on. The switch hook must also be held down completely when you press **⏻** and turn the headset off.

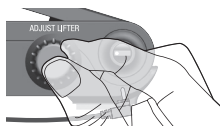

Headset base and handset lifter installation

Installation of large lifter pad (optional)

If the small lifter pad cannot hold the corded handset steadily, you can attach a large lifter pad (provided) to enlarge the contact area.

1. Hold the large lifter pad in front of the small lifter pad as shown below.
2. Insert the large lifter pad into the two front gaps of the small lifter pad.

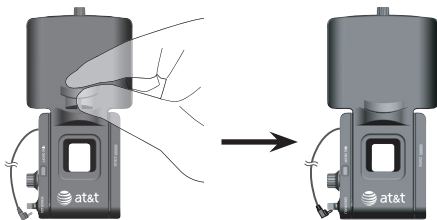

Installation of anti-slip pad (optional)

The anti-slip pad (provided) helps prevent your corded handset from slipping from the lifter.

1. Position the anti-slip pad above the small lifter pad.
2. Peel off the protective strip from the anti-slip pad.
3. Carefully return the anti-slip pad to the predetermined position and replace the corded handset on the lifter.

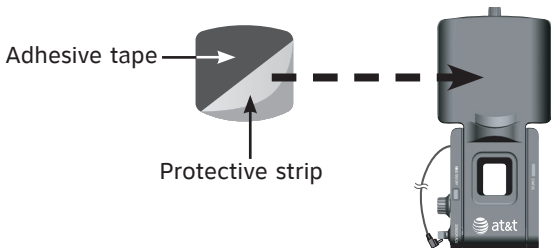

About internal and auxiliary ring detectors

The internal or auxiliary ring detector detects the telephone ringer and sends a ring tone to the headset earpiece.

If you installed the lifter over the top of the corded phone speaker, the internal ring detector will recognize when the phone rings. However, if your corded phone speaker is located elsewhere on the phone, stick the auxiliary ring detector to the speaker as shown below.

Install the auxiliary ring detector

1. Insert the auxiliary ring detector plug into the **RING DETECT** jack on the lifter.
2. Remove the protective strip from the adhesive tape on the auxiliary ring detector.
3. Stick the auxiliary ring detector to the center of the corded phone speaker.

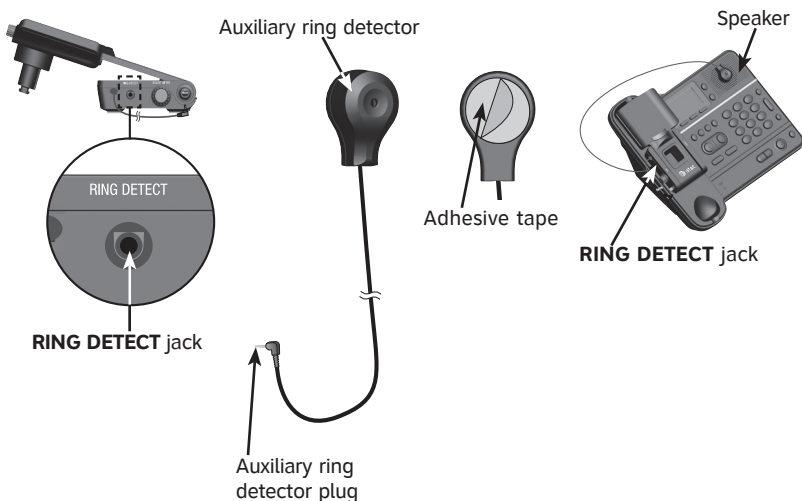

About internal and auxiliary ring detectors

Ring detector on/off

When the ring detector detects an incoming call, it sends a ring tone to the headset earpiece.

- Press the **RING ON/OFF** button on the lifter to turn the ring detector on or off. The **STATUS** light is blue when the ring detector is turned on. The **STATUS** light is red when the ring detector is turned off.
- When the ring detector is turned off, it does not send a ring tone to the headset. The **⓪** light on the headset does not flash when there is an incoming call.



NOTE: When you are using the speakerphone of your telephone, the ring detector may send a ring tone to the headset. If you do not want the headset to ring, press the **RING ON/OFF** button to turn the ring detector off. After the call, you can press the **RING ON/OFF** button again to turn the ring detector back on.

Adjust the sensitivity level

The default setting of the ring detector works with most corded telephones. However, the ring detector might need some adjustments to recognize less common telephone ring tones.

To adjust the ring detector sensitivity while the telephone is ringing:

- Turn the **SENSOR ADJ** knob clockwise to increase the sensitivity.
- Turn the **SENSOR ADJ** knob counterclockwise to decrease the sensitivity.

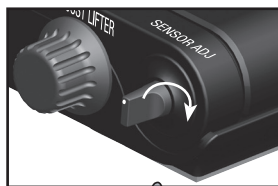

When the ring detector detects the telephone ringer correctly:

- The **STATUS** light on the lifter flashes quickly when the telephone rings.
- The detector sends the ring tone to the headset earpiece.

Headset attachments

Earbud

There are a total of six earbuds provided. One of them has been attached to the headset. They come in three sizes of which there are two types: one normal and one providing a deeper fit. Follow the steps below to change the earbud.

To remove the earbud from the headset earpiece:

Hold both sides of the earbud. Twist and pull the earbud until it separates from the earpiece.

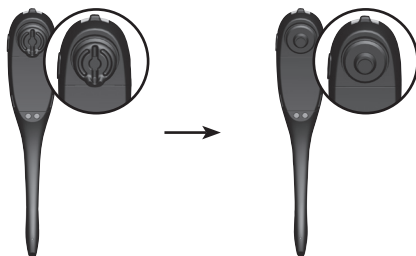

To attach the earbud to the headset earpiece:

1. Choose an appropriate earbud.
2. Position the earbud on the earpiece as shown below.
3. Press the earbud down on the earpiece until it clicks into place. Move the earbud around so that the protruding bump on the earbud is pointing towards your mouth when placed on your ear.

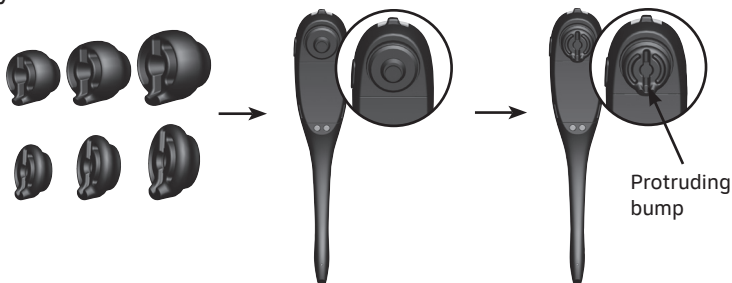

Headset attachments

Over the ear hook

There are two ear hooks provided. Choose the size that best fits your need to attach to the headset. Follow the steps below to attach an ear hook to the headset.

To position the headset to wear on the left or right ear:

- To wear on the left ear:
 1. Make sure the ear hook loop is positioned as shown in Figure 1 on the right.
 2. Attach the ear hook to the headset as instructed on the next page.



Figure 1

- To wear on the right ear:
 1. Make sure the ear hook loop is positioned as shown in Figure 2 on the right.
 2. Attach the ear hook to the headset as instructed on the next page.

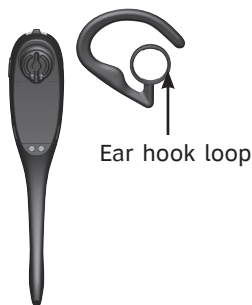

Figure 2

Headset attachments

To attach the ear hook to the headset:

1. Make sure there are no headset attachment, except the earbud, connected to the headset.
2. Insert the earpiece into the ear hook loop as shown in Figure 3.
3. Press the edge of the ear hook loop towards the earpiece until it clicks into place as shown in Figure 4.
4. Hook the headset onto the desired ear. Adjust the angle of the headset until the microphone is pointing towards your mouth as shown in Figure 5.

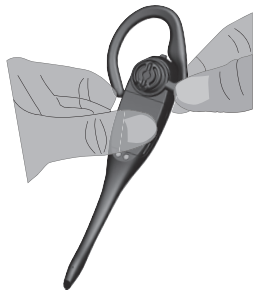

Figure 3

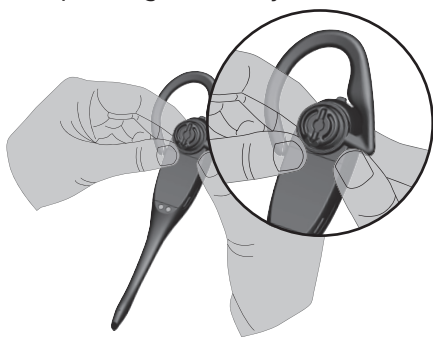

Figure 4

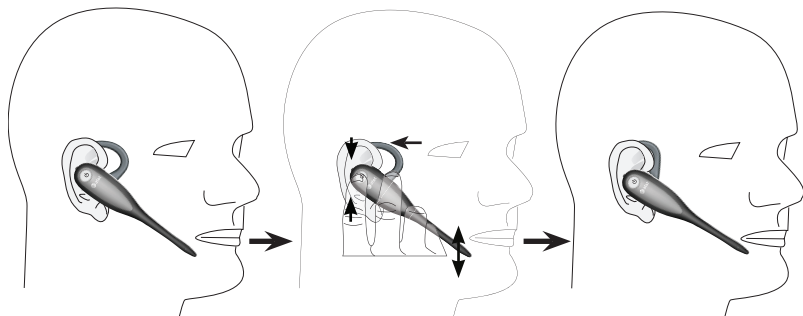

Figure 5

Headset attachments

To remove the ear hook from the headset:

Hold the headset with one hand. Twist and pull the ear hook with the other hand until it separates from the earpiece.



Headset attachments

Over the head band

To attach the head band to the headset:

1. Make sure there are no headset attachment, except the earbud, connected to the headset.
2. Insert the earpiece into the loop of the ear pad as shown in Figure 6.
3. Push the earpiece into the ear pad until it clicks into place as shown in Figure 7.
4. Adjust the head band to fit your head. Adjust and rotate the angle of the headset until the microphone is pointing towards your mouth as shown in Figure 8.

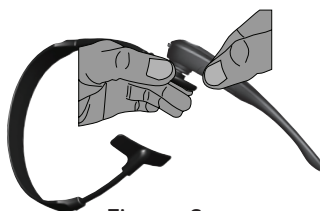

Figure 6

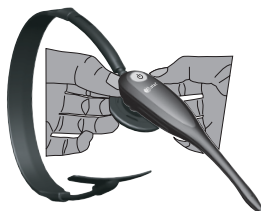

Figure 7

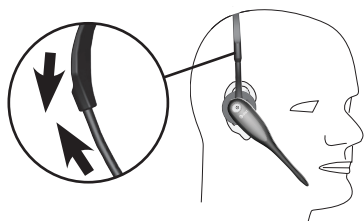

Figure 8



NOTES:

- To wear on the other ear, rotate the headset within the loop of the ear pad.
- Firmly grip the ear pad with one hand whenever adjusting the headset microphone up or down.

Headset attachments

To remove the head band from the headset:

Hold the headset with one hand and the ear pad with the other hand. Twist and pull the headset until it separates from the ear pad.

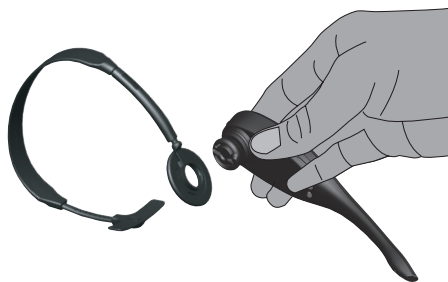
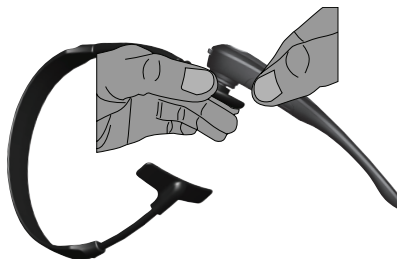

Headset attachments

Behind the neck band

By default, the ear pad on the neck band is positioned to be worn on the right ear.

To attach the headset to the neck band:

1. Make sure there are no headset attachment, except the earbud, connected to the headset.
2. Insert the earpiece into the loop of the ear pad as shown in Figure 9.
3. Gently press the earpiece inward until it clicks into place as shown in Figure 10.
4. Place the neck band around your neck and over your ears.
5. Adjust and rotate the angle of the headset until the microphone is pointing towards your mouth as shown in Figure 11.



Figure 9



Figure 10

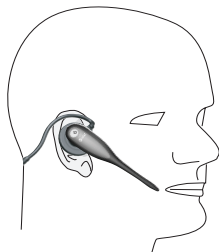

Figure 11

Headset attachments

To wear the headset on your left ear:

1. Remove the ear pad and supporting pad from the neck band by carefully pulling them up through the stems at the end of the neck band as shown in Figure 12.



Figure 12

2. Snap the socket of the ear pad into the stem at the left end of the neck band. Snap the socket of the supporting pad into the stem at right end of the neck band as shown in Figure 13.



Figure 13

3. Follow Steps 1-5 in **To attach the headset to the neck band** on page 34.

Headset attachments

To remove the neck band from the headset:

Hold the headset with one hand and the ear pad with the other hand. Twist and pull the headset until it separates from the ear pad.



Headset operation

Power on/off the headset

Power on the headset before use.

To power on the headset:

- Place the headset in the headset base.

-OR-

- Press and hold Φ for two seconds.

The Φ light flashes blue three times and you hear three beeps when it is being powered on.

Power off the headset if it will not be used for a long time.

To power off the headset:

- Press and hold Φ for four seconds.

The Φ light flashes red three times and you hear three beeps when it is being powered off.

PHONE mode and PC mode

Before using the headset, you may change the default mode of your headset. When the headset is not in use and you press Φ , your headset automatically switches to the default mode you selected. When the headset is not in use, you can choose between PHONE mode and PC mode.

To choose PHONE mode:

- Press the **PHONE** button on the headset base. The **PHONE** light turns on.

To choose PC mode:

- Press the **PC** button on the headset base. The **PC** light turns on.

PHONE mode

Make a call

To make calls on your home or office telephone line, press **PHONE** on the headset base for PHONE mode.

When the headset base is connected to the corded handset of your telephone with the handset lifter installed:

1. Press **⓪** on the headset. The switch hook presser rises and releases the switch hook. You hear a dial tone in the headset earpiece.
2. Dial the telephone number using the dialing keys.

When the headset base is connected to a telephone wall jack:

1. Follow the instructions in your telephone user's manual for making calls.
2. Press **⓪** on the headset at any time to join the call.
3. After you join the call, you can hang up the telephone and continue the call on the headset.



NOTES:

- You cannot switch a call from the headset to the corded handset.
- If you plug the headset into a telephone line without a telephone connected, you are unable to make calls.

Answer a call

When the headset base is connected to the corded handset of your telephone with the handset lifter installed:

- Press **⓪** on the headset to answer an incoming call. The switch hook presser rises and releases the switch hook. You hear the caller through the headset earpiece.

When the headset base is connected to a telephone wall jack:

- Press **⓪** on the headset.

PHONE mode

End a call

When the headset base is connected to the corded handset of your telephone with the handset lifter installed:

- Press **⏏** on the headset to end a call. The switch hook presser pushes down the switch hook and ends the call.

When the headset base is connected to a telephone wall jack:

- Press **⏏** on the headset or place the headset in the headset base.

Headset ringer

The headset base and headset do not have external ringers. When you receive calls, the headset earpiece rings. If you have telephones connected to the same telephone line as the headset base, you can rely on the ringers of those telephones to alert you to incoming calls.

To change the volume of the earpiece ringer:

- Slide the volume switch at the top of the headset towards **VOL+** or **VOL-** when the headset is not in use.

To turn off the earpiece ringer:

- Slide the volume switch at the top of the headset towards **VOL-** until you hear two beeps when the headset is not in use.

PHONE mode

Temporary ringer silencing

Press **MUTE** to temporarily silence the ringer in the headset earpiece. This silences the ringer without disconnecting the call. The next incoming call rings normally at the preset volume.



NOTE: If you have more than one headset registered to the headset base, both headset earpieces ring when there is an incoming call. Pressing **MUTE/FLASH** on one headset only silences the ringer of that headset.

Call waiting

If you subscribe to call waiting service offered by your telephone service provider, you will hear a call waiting alert tone if someone calls you while you are in the middle of a call.

- Press down the **FLASH** switch at the top of the headset to put your current call on hold and answer the new call.
- Press the **FLASH** switch again at any time to switch back and forth between calls.



Options while on calls

Volume control

To adjust the listening volume:

- While on a call, slide the volume switch at the top of the headset towards **VOL+** or **VOL-** to adjust the listening volume.

To adjust the speaking volume:

- While on a call, press **▼ VOLUME ▲/MICROPHONE** on the right side of the headset base to adjust the speaking volume.



NOTES:

- Listening volume settings are independent for each headset, but the speaking volume is shared by all registered headsets.
- When the listening volume reaches the minimum or maximum setting, you hear two beeps.
- When the speaking volume reaches the minimum or maximum setting, you hear three beeps.

Options while on calls

Mute

The mute function turns off the headset microphone. You can hear the caller, but the caller cannot hear you.

To mute a call:

- Press **MUTE** on the headset to turn off the headset microphone. The voice prompt "Mute on" plays. The **MUTE** light on the headset base flashes and a short beep plays every 30 seconds.



To take a call off mute:

- Press **MUTE** on the headset to resume the two-way conversation. You hear the voice prompt "Mute off".

Multiple headsets use

If you have more than one headset registered to the same headset base, when one of the headsets is on an external call, the other headset can join the call in progress.

- To join a call on the other headset, press **⏻** on that headset.
- To end the call, press **⏻** or place the headset in the headset base. The call ends only when all handsets hang up.

Options while on calls



Switching between PHONE mode and PC mode

You can switch back and forth between PHONE mode and PC mode while on a call by pressing the corresponding mode button on the headset base. Once selected, the PHONE mode light or the PC mode light flashes twice every three seconds to indicate that line is on hold.

When you have two registered headsets in use at the same time, you can still change the mode by pressing the corresponding mode button on the headset base.

While on a call:

- Press the **PHONE** button on the headset base when in PC mode. The PC call is put on hold.
- Press the **PC** button on the headset base when in PHONE mode. The PHONE call is put on hold.

Press  on the headset to end the call you are on and press  again to connect to the call on hold.



NOTE: There is a ring back tone on the headset for one minute when a PHONE call is put on hold for 14 minutes. At 15 minutes on hold, the call will be automatically disconnected.



Adding and registering headsets

The TL7812 supports up to two cordless headsets. The headset provided with your TL7812 is already registered. You can add a new headset (TL7800, purchased separately) to the headset base. You must register a new headset with the headset base before use (see page 45).



You can only register one headset to the headset base at a time. You must deregister the headset from the headset base (see page 46) before registering it to another headset base.

Adding and registering headsets

Register a headset to the headset base

1. Make sure the battery is properly installed in the headset (see page 12). The  light flashes slowly in red and blue to indicate the headset is not registered.
2. Place the headset in the headset base and allow it to charge for at least one hour before beginning registration.
3. Remove the headset from the headset base.
4. Press and hold the **PAIR** button (about four seconds) until the **MUTE** light on the headset base turns on and then release the button.
5. Return the headset to the headset base for registration. The  light flashes quickly in red and blue.

It takes about 60 seconds to complete the registration process. The  light turns red when the headset is registered but not fully charged, or turns blue when it is registered and fully charged.

If the registration fails, you hear the voice prompt "Not registered" when you press the  button on the headset, and the  light on the headset flashes slowly in red and blue.

To reset the headset, remove it from the headset base and try the registration process again.



NOTE: You cannot register a headset if another system headset is in use.

Deregistering headsets

You may need to deregister your headsets if:

You wish to register your headset to a different headset base.

-OR-

You have two registered headsets and need to replace one of them. You must first deregister both headsets, and then register each headset you wish to use again, one at a time.

Please read carefully through all the instructions on this page before beginning the deregistration process.

Deregister all headsets from the headset base

1. Press and hold the **PAIR** button on the headset base (at least 10 seconds) until the **MUTE** light on the headset base turns on and starts to flash, then release the **PAIR** button.
2. Immediately press and release the **PAIR** button again. You must press the **PAIR** button while the **MUTE** light is still flashing. (The light flashes for about seven seconds. If the light stops flashing, start again with Step 1 above.)



It takes about 10 seconds to complete the deregistration process. The  light flashes slowly in red and blue when the deregistration process is successful.

3. To register the headset(s) to the headset base again, follow the registration instructions on page 45.



NOTES:

- You cannot deregister the headset(s) if any system headset is in use.
- Even if the battery is depleted, you can still deregister the headset by following the steps above.

Troubleshooting

If you have difficulty with your telephone, please try the suggestions below. For customer service, visit our website at **www.telephones.att.com/smb** or call **1 (800) 222-3111**. In Canada, dial **1 (866) 288-4268**.

My headset doesn't work at all.

- Make sure the power cord is securely plugged in.
- Make sure that the battery is securely installed in the cordless headset.
- Make sure the telephone line cord is securely and firmly plugged into the headset base and the telephone wall jack.
- Charge the battery in the cordless headset for at least three hours. For optimum daily performance, return the cordless headset to its base when not in use.
- Reset the headset. Power off the headset and then power it on (page 37). Allow up to one minute for the cordless headset and headset base to reset.
- Reset the headset base. Unplug the unit's electrical power. Wait for approximately 15 seconds, then plug it back in. Allow up to one minute for the cordless headset and headset base to reset.
- Other electronic products such as HAM radios and other DECT phones can cause interference with your cordless headset. Try installing your headset base as far away as possible from these types of electronic devices.
- You may need to purchase a new battery. Refer to the **Battery installation** section on page 12 of this user's manual.

The other party cannot hear my voice during a call.



- Adjust the speaking volume during a call (page 41).

Troubleshooting

There is no dial tone.

- Try all the suggestions above.
- Move the cordless headset closer to the headset base. You might have moved out of range.
- Make sure that the **CORDED HANDSET CONNECTED** switch is set properly (page 16, 18 or 20).
- Your telephone line cord may be defective. Install a new telephone line cord.
- Another phone on the same phone line may be in use.
- If the previous suggestions do not work, disconnect the headset base from the telephone jack and connect another phone to that jack. If there is no dial tone on that phone either, the problem is in your wiring or local service. Contact your telephone service provider.

The battery does not charge.

- Make sure that the battery is securely installed in the cordless headset.
- If the cordless headset is in its headset base but the  light on the headset does not turn on, refer to **The  light on the headset is off while charging** in this **Troubleshooting** guide.
- Charge the battery in the cordless headset for at least three hours. For optimum daily performance, return the cordless headset to the headset base when not in use.
- You may need a new battery. Refer to the **Battery installation** section on page 12.
- Your headset might be defective. Refer to the **Limited warranty** section on pages 65-67 for further instructions.

Troubleshooting

I cannot dial out.

- Try all the suggestions above.
- You must use a telephone on the same line to dial out. Once you have dialed the number, you can press **Ⓟ** to join the call (page 38).
- If other phones in your home or office are having the same problem, the problem is in your wiring or local service. Contact your telephone service provider (charges may apply).

My cordless headset isn't performing normally.

- Make sure the power cord is securely plugged into the headset base. Plug the unit into a different, working electrical outlet not controlled by a wall switch.
- Move the cordless headset closer to the headset base. You might have moved out of range.
- Reset the headset. Power off the headset and then power it on (page 37). Allow up to one minute for the cordless headset and headset base to reset.
- Reset the headset base. Unplug the unit's electrical power. Wait for 15 seconds, then plug it back in. Allow up to one minute for the cordless headset and headset base to reset.
- Other electronic products such as HAM radios and other DECT phones can cause interference with your cordless headset. Try installing your headset as far away as possible from these types of electronic devices.

Troubleshooting

I get noise, static, or a weak signal even when I'm near the headset base.

- If you subscribe to high-speed Internet service (DSL - digital subscriber line) through your telephone line, you must install a DSL filter between the telephone line cord and the telephone wall jack. The filter prevents noise and caller ID problems caused by DSL interference. Contact your DSL service provider for more information about DSL filters.
- You may be able to improve the performance of your cordless headset by installing the headset base at least one foot from any cordless telephone system. If separating them by one foot does not help, try moving the headset farther away.
- Other electronic products such as HAM radios and other DECT phones can cause interference with your cordless headset. Try installing your headset as far away as possible from these types of electronic devices.
- Do not install this headset near a microwave oven or in the same electrical outlet. You may experience decreased performance while the microwave oven is operating.
- If your headset is located near a modem, move your headset and modem further apart from each other.
- Relocate your headset base to a higher location. You may experience better reception by elevating the headset base.
- If other phones in your home or office are having the same problem, the problem is in your wiring or local service. Contact your telephone service provider (charges may apply).

Troubleshooting

I cannot hear a ring tone from the headset when there is an incoming call.

- The headset does not have an external ringer. You can only hear the ring tone when you are wearing the earpiece.
- If you have pressed **MUTE** on the headset when it is ringing, it mutes the ring tone of the headset. The ring tone resumes on the next call.
- You may have too many extension phones on your telephone line to allow all of them to ring simultaneously. Try unplugging some of the other phones.
- The layout of your home or office might be limiting the operating range. Try moving the headset base to another location, preferably to a higher location.
- Other electronic products such as HAM radios and other DECT phones can cause interference with your cordless headset. Try installing your headset base as far away as possible from these types of electronic devices.
- Install the battery again, and then place the cordless headset in the headset base. Wait for the cordless headset to reestablish its connection with the headset base. Allow up to one minute for this to take place.
- Your telephone line cord may be defective. Install a new telephone line cord.
- If other phones in your home or office are having the same problem, the problem is in your wiring or local service. Contact your telephone service provider (charges may apply).
- Test a working phone at the phone jack. If another phone has the same problem, there may be a problem with the phone jack, wiring or service. Contact your telephone service provider (charges may apply).

Troubleshooting

I hear other calls while using my headset.

- Plug a different telephone into the telephone jack that you are currently using. If you still hear other calls, the problem is probably in your building's wiring or local service. Call your telephone service provider.

I cannot hear any audio using my headset in PC mode.

- Make sure the two ends of the USB cable are securely plugged into the computer and headset base USB ports.
- Make sure PC mode is selected and the **PC** light is on.
- Make sure you have pressed **Ⓞ** on your headset to receive the audio from your computer.
- Make sure you are using a software program that supports VoIP calling (such as Skype or Microsoft Lync).
- Make sure the headset listening volume is turned on and set to an audible level in your computer audio settings and your VoIP calling software.
- Make sure the audio settings in your VoIP calling software are set to use your "AT&T DECT Headset".

The person on the other end cannot hear me in PC mode.

- Make sure the two ends of the USB cable are securely plugged into the computer and headset base USB ports.
- Make sure PC mode is selected and the **PC** light is on.
- Make sure you have pressed **Ⓞ** on your headset to receive the audio from your computer.
- Make sure you are using a software program that supports VoIP calling (such as Skype or Microsoft Lync).
- Make sure the headset microphone volume is turned on and set to an audible level in your computer audio settings and in your VoIP calling software.
- Make sure the audio settings in your VoIP calling software are set to use your "AT&T DECT Headset".

Troubleshooting

I want to use my headset with a different headset base.

- You need to deregister the headset from the current headset base (page 46), and then register it to the new headset base (page 45).

I cannot answer an incoming call in PC mode.

- Your headset cannot directly answer a call to your computer. You must answer all incoming calls on your computer through your VoIP program.
- Make sure PC mode is selected on the headset base and the **PC** light is on.
- Make sure you have pressed **Ⓞ** on your headset to receive the audio from your computer.
- Make sure the headset listening volume is turned on and set to an audible level in your computer audio settings and your VoIP calling software.

My calls cut in and out while I'm using my cordless headset.

- Other electronic products such as HAM radios and other DECT phones can cause interference with your cordless headset. Try installing your headset base as far away as possible from these types of electronic devices.
- Do not install the headset near a microwave oven or on the same electrical outlet. You may experience decreased performance while the microwave oven is operating.
- If your headset is located near a modem, move your headset and modem further apart from each other.
- Relocate your headset base to a higher location. The headset will have better reception when not installed in a low area.
- If other phones in your home or office are having the same problem, the problem is in your wiring or local service. Contact your telephone service provider (charges may apply).

Troubleshooting

The ϕ light on the headset is off while charging.

- Make sure the power and line cords are plugged in correctly and securely.
- Make sure that the battery is securely installed in the cordless headset.
- Make sure the headset is sitting properly in the base to charge.
- Unplug the unit's electrical power. Wait for 15 seconds, then plug it back in. Allow up to one minute for the cordless headset and headset base to reset.
- Clean the cordless headset and headset base charging contacts each month using a pencil eraser or dry cloth.
- Your headset or headset base might be defective. Refer to the **Limited warranty** section on pages 65-67 for further instructions.

The switch hook presser of the handset lifter doesn't rise at all.

- Make sure the **CORDED HANDSET CONNECTED** switch on the headset base is set to **YES**.
- Make sure the lifter control cable is securely plugged into the **LIFTER** jack on the headset base.
- Make sure all cords and the telephone line cord are securely connected to the proper sockets.
- Make sure the headset base has power.
- Make sure your headset is charged and registered to the headset base.

Troubleshooting

When I press ϕ on the headset, the handset lifter rises, but the call is not connected or I do not hear a dial tone.

- Try all the suggestions above.
- When using the handset lifter, make sure the **CORDED HANDSET CONNECTED** switch on the headset base is set to **YES** and the telephone line cord is connected to the telephone line jack on the back of the corded phone.
- The handset lifter may not rise high enough to release the switch hook. Try to adjust the height of the lifter arm by turning the **ADJUST LIFTER** knob until it reaches the desired angle. Adjust the switch hook presser by turning the switch hook presser adjustment knob so that the switch hook is released when the lifter arm rises.
- If you cannot hear a dial tone when the headset is on, you should adjust the quality of the corded handset audio first. During a call, slide the corded handset audio adjust switch at the bottom of the headset base from **A** to **F** until you obtain good sound quality.
- If the previous suggestions don't work, disconnect the telephone base from the telephone jack and connect a different telephone. If there is no dial tone on that telephone either, the problem is in your wiring or local service. Contact your telephone service provider.
- Your line cord might be defective. Install a new line cord.

Troubleshooting

My corded phone is ringing, but my headset is not ringing.

- Make sure the **CORDED HANDSET CONNECTED** switch on the headset base is set to **YES**.
- Make sure that the **RING ON/OFF** button on the lifter is turned on. If the **RING ON/OFF** button is turned off, the headset does not ring.
- If the speaker of your corded phone is not located under the lifter, install the auxiliary ring detector. See page 26 for instructions.
- It may be necessary to adjust the sensitivity of the ring detector. See page 27 for instructions.
- If an auxiliary ring detector is used, make sure its cord is completely plugged into the handset lifter.
- Make sure all cords and the telephone line cord are plugged into the appropriate outlets.
- Make sure your headset is charged.

I cannot dial out on the headset when the CORDED HANDSET CONNECTED switch is set to YES.

- Try all the suggestions above.
- Make sure you have a dial tone before dialing. It is normal for a telephone base to take a second or two before producing a dial tone. Wait an extra second before dialing.

The other party cannot hear my voice during a call.

- Make sure your headset microphone is not muted.
- During a call, slide the corded handset audio adjust switch at the bottom of the headset base from **A** to **F** until you obtain good sound quality.

Troubleshooting

Nothing happens when I move the corded handset audio adjust switch.

- When the handset lifter is used, make sure the **CORDED HANDSET CONNECTED** switch on the headset base is set to **YES**. Slide the corded handset audio adjust switch at the bottom of the headset base from **A** to **F** until you obtain good sound quality.

My headset is ringing even when there is no incoming call.

- The sensitivity level of your ring detector may be too high. See page 27 to adjust the sensitivity level.
- The ring detector may detect a sound from the environment and send a ring tone to the headset. See page 27 to turn off the ring detector.
- When you are using the speakerphone of your telephone, the ring detector may send a ring tone to the headset. If you do not want the headset to ring, press the **RING ON/OFF** button to turn the ring detector off. After the call, you can press the **RING ON/OFF** button again to turn the ring detector back on.

Common cure for electronic equipment.

If the unit does not seem to be responding normally, try putting the cordless headset in its base. If it does not respond, do the following (in the order listed):

- Disconnect the power to the headset base.
- Remove the cordless headset battery.
- Wait a few minutes.
- Connect the power to the headset base.
- Install the battery again, and then place the cordless headset into the headset base.
- Wait for the cordless headset to reestablish its connection with the headset base. Allow up to one minute for this to take place.

Maintenance

Taking care of your headset

- Your cordless headset contains sophisticated electronic parts, so it must be treated with care.
- Avoid rough treatment.
- Place the headset down gently. Save the original packing materials to protect your headset if you ever need to ship it.

Avoid water

- Your headset can be damaged if it gets wet. Do not use the headset outdoors in the rain, or handle it with wet hands. Do not install the headset base near a sink, bathtub or shower.

Electrical storms

- Electrical storms can sometimes cause power surges harmful to electronic equipment. For your own safety, take caution when using electrical appliances during storms.

Cleaning your headset

- Your headset has a durable plastic casing that should retain its luster for many years. Clean it only with a soft cloth slightly dampened with water or a mild soap.
- Do not use excess water or cleaning solvents of any kind.

Remember that electrical appliances can cause serious injury if used when you are wet or standing in water. If the headset base should fall into water, DO NOT RETRIEVE IT UNTIL YOU UNPLUG THE POWER CORD AND TELEPHONE LINE CORD FROM THE WALL, then pull the unit out by the unplugged cords.

Important safety information



This symbol is to alert you to important operating or servicing instructions that may appear in this user's manual. Always follow basic safety precautions when using this product to reduce the risk of injury, fire, or electric shock.

Safety information

- **Read and understand all instructions in the user's manual. Observe all markings on the product.**
- **Avoid using a headset during a thunderstorm.** There may be a slight chance of electric shock from lightning.
- **Do not use the headset to report a gas leak in the vicinity of the leak.** Under certain circumstances, a spark may be created when the adapter is plugged into the power outlet, or when the headset is replaced in its cradle. This is a common event associated with the closing of any electrical circuit. The user should not plug the headset base into a power outlet, and should not put a charged headset into the cradle, if the headset base is located in an environment containing concentrations of flammable or flame-supporting gases, unless there is adequate ventilation. A spark in such an environment could create a fire or explosion. Such environments might include: medical use of oxygen without adequate ventilation; industrial gases (cleaning solvents; gasoline vapors; etc.); a leak of natural gas; etc.
- **Do not use this product near water, or when you are wet.** For example, do not use it in a wet basement or shower, or next to a swimming pool, bathtub, kitchen sink, or laundry tub. Do not use liquids or aerosol sprays for cleaning. If the product comes in contact with any liquids, unplug any line or power cord immediately. Do not plug the product back in until it has dried thoroughly.
- **Install this product in a protected location** where no one can trip over any line or power cords. Protect cords from damage or abrasion.
- **If this product does not operate normally, see the Troubleshooting section on pages 47-57 of this user's manual.** If you cannot solve the problem, or if the product is damaged, refer to the **Limited warranty** section on pages 65-67. Do not open this product except as may be directed in your user's manual. Opening the product or reassembling it incorrectly may expose you to hazardous voltage or other risks.
- **Replace batteries only as described in your user's manual (page 12).** Do not burn or puncture batteries — they contain caustic chemicals.
- **This power adapter is intended to be correctly oriented in a vertical or floor mount position.** The prongs are not designed to hold the plug in place if it is plugged into a ceiling, an under-the-table or a cabinet outlet.

Important safety information



Caution: Use only the power adapter provided with this product. To obtain a replacement, visit our website at

www.telephones.att.com/smb or call
1 (800) 222-3111. In Canada, dial **1 (866) 288-4268**.

Especially about cordless headsets

- **Privacy:** The same features that make a cordless headset convenient create some limitations. Telephone calls are transmitted between the headset base and the headset by radio waves, so there is a possibility that your cordless headset conversations could be intercepted by radio receiving equipment within range of the cordless headset. **For this reason, you should not think of cordless headset conversations as being as private as those on corded telephones.**
- **Electrical power:** The headset base of this cordless headset must be connected to a working electrical outlet which is not controlled by a wall switch. **Calls cannot be made from the headset if the headset base is unplugged or switched off, or if the electrical power is interrupted.**
- **Potential TV interference:** Some cordless headsets operate at frequencies that may cause interference to TVs and VCRs. To minimize or prevent such interference, do not place the headset base of the cordless headset near or on top of a TV or VCR. If interference is experienced, moving the cordless headset farther away from the TV or VCR will often reduce or eliminate the interference.
- **Rechargeable batteries:** This product contains lithium-ion rechargeable batteries. Exercise care in handling batteries in order not to create a short circuit with conductive material such as rings, bracelets and keys. The battery or conductor may overheat and cause harm. Observe proper polarity between the battery and the battery charger.
- **Lithium-ion rechargeable batteries:** Dispose of these batteries in a safe manner. Do not burn or puncture. Like other batteries of this type, if burned or punctured, they could release caustic material which could cause injury.



The RBRC™ Seal means that the manufacturer is voluntarily participating in an industry program to collect and recycle lithium-ion rechargeable batteries when taken out of service within the United States. These batteries may be taken to a participating local retailer of replacement batteries or recycling center. Or you may call 1-800-8-BATTERY for locations accepting spent Li-ion batteries.

Important safety information

CAUTION

- There may be a risk of explosion if you use a wrong type of battery. Use only the supplied rechargeable battery or replacement battery (model BT191665).
- Change this product's batteries only in accordance with the instructions and limitations specified in this manual.
- As with any batteries, do not allow conductive materials such as rings, bracelets or keys to come in contact with the metallic parts of the battery. The battery or conductor may overheat and cause harm.
- Do not open or damage the batteries. Released electrolyte is corrosive and may cause injury to the eyes or skin. The electrolyte may be toxic if swallowed.
- Do not dispose of the batteries in a fire. Check with local waste management codes for special disposal instructions. To prevent fire or shock hazard, do not expose this product to water or any type of moisture.
- Observe proper polarity orientation between the battery and metallic contacts.
- Do not disassemble your headset. There are no user-serviceable parts inside. Refer to qualified service personnel for servicing.

Precautions for users of implanted cardiac pacemakers

Cardiac pacemakers (applies only to digital cordless devices):

Wireless Technology Research, LLC (WTR), an independent research entity, led a multidisciplinary evaluation of the interference between portable digital cordless devices and implanted cardiac pacemakers. Supported by the U.S. Food and Drug Administration, WTR recommends to physicians that:

Pacemaker patients

- Should keep digital cordless devices at least six inches from the pacemaker.
- Should NOT place digital cordless devices directly over the pacemaker, such as in a breast pocket, when it is turned ON.
- Should use the digital cordless device at the ear opposite the pacemaker.

WTR's evaluation did not identify any risk to bystanders with pacemakers from other persons using digital cordless devices.

SAVE THESE INSTRUCTIONS

FCC Part 68 and ACTA

This equipment complies with Part 68 of the FCC rules and with technical requirements adopted by the Administrative Council for Terminal Attachments (ACTA). The label on the back or bottom of this equipment contains, among other things, a product identifier in the format US: AAAEQ##TXXXX. This identifier must be provided to your telephone service provider upon request.

The plug and jack used to connect this equipment to premises wiring and the telephone network must comply with applicable Part 68 rules and technical requirements adopted by ACTA. A compliant telephone cord and modular plug is provided with this product. It is designed to be connected to a compatible modular jack that is also compliant. An RJ11 jack should normally be used for connecting to a single line and an RJ14 jack for two lines. See the installation instructions in the user's manual.

The Ringer Equivalence Number (REN) is used to determine how many devices you may connect to your telephone line and still have them ring when you are called. The REN for this product is encoded as the 6th and 7th characters following the US: in the product identifier (e.g. if ## is 03, the REN is 0.3). In most, but not all areas, the sum of all RENs should be five (5.0) or less. For more information, please contact your telephone service provider.

This equipment may not be used with party lines. If you have specially wired alarm dialing equipment connected to your telephone line, ensure the connection of this equipment does not disable your alarm equipment. If you have questions about what will disable alarm equipment, consult your telephone service provider or a qualified installer.

If this equipment is malfunctioning, it must be unplugged from the modular jack until the problem has been corrected. Repairs to this telephone equipment can only be made by the manufacturer or its authorized agents. For repair procedures, follow the instructions outlined under the Limited warranty.

If this equipment is causing harm to the telephone network, the telephone service provider may temporarily discontinue your telephone service. The telephone service provider is required to notify you before interrupting service. If advance notice is not practical, you will be notified as soon as possible. You will be given the opportunity to correct the problem and the telephone service provider is required to inform you of your right to file a complaint with the FCC. Your telephone service provider may make changes in its facilities, equipment, operation, or procedures that could affect the proper functioning of this product. The telephone service provider is required to notify you if such changes are planned.

FCC Part 68 and ACTA

If this product is equipped with a corded or cordless handset, it is hearing aid compatible.

If this product has memory dialing locations, you may choose to store emergency telephone numbers (e.g. police, fire, medical) in these locations. If you do store or test emergency numbers, please:

Remain on the line and briefly explain the reason for the call before hanging up.

Perform such activities in off-peak hours, such as early morning or late evening.

Industry Canada

Operation is subject to the following two conditions: (1) this device may not cause harmful interference, and (2) this device must accept any interference, including interference that may cause undesired operation.

The term "IC:" before the certification/registration number only signifies that the Industry Canada technical specifications were met.

The Ringer Equivalence Number (REN) for this terminal equipment is 1.0. The REN is an indication of the maximum number of devices allowed to be connected to a telephone interface. The termination on an interface may consist of any combination of devices subject only to the requirement that the sum of the RENs of all the devices does not exceed five.

This product meets the applicable Industry Canada technical specifications.

FCC Part 15

This equipment has been tested and found to comply with the requirements for a Class B digital device under Part 15 of the Federal Communications Commission (FCC) rules.

These requirements are intended to provide reasonable protection against harmful interference in a residential installation. This equipment generates, uses and can radiate radio frequency energy and, if not installed and used in accordance with the instructions, may cause harmful interference to radio communications. However, there is no guarantee that interference will not occur in a particular installation.

If this equipment does cause harmful interference to radio or television reception, which can be determined by turning the equipment off and on, the user is encouraged to try to correct the interference by one or more of the following measures:

- Reorient or relocate the receiving antenna.
- Increase the separation between the equipment and receiver.
- Connect the equipment into an outlet on a circuit different from that to which the receiver is connected.
- Consult the dealer or an experienced radio/TV technician for help.

Changes or modifications to this equipment not expressly approved by the party responsible for compliance could void the user's authority to operate the equipment.

This device complies with Part 15 of the FCC Rules. Operation is subject to the following two conditions: (1) this device may not cause harmful interference, and (2) this device must accept any interference received, including interference that may cause undesired operation. Privacy of communications may not be ensured when using this device.

To ensure safety of users, the FCC has established criteria for the amount of radio frequency energy that can be safely absorbed by a user or bystander according to the intended usage of the product. This product has been tested and found to comply with the FCC criteria. The headset may be safely held against the ear of the user. The headset base shall be installed and used such that parts of the user's body other than the hands are maintained at a distance of approximately 20 cm (8 inches) or more.

This Class B digital apparatus complies with Canadian ICES-003.

Limited warranty

The AT&T brand is used under license - any repair, replacement or warranty service, and all questions about this product should be directed to: In the United States of America, visit **www.telephones.att.com/smb** or call **1 (800) 222-3111**. In Canada, call **1 (866) 288-4268**.

1. What does this limited warranty cover?

The manufacturer of this AT&T branded product warrants to the holder of a valid proof of purchase (“CONSUMER” or “you”) that the product and all accessories provided in the sales package (“PRODUCT”) are free from defects in material and workmanship, pursuant to the following terms and conditions, when installed and used normally and in accordance with the PRODUCT operating instructions. This limited warranty extends only to the CONSUMER for products purchased and used in the United States of America and Canada.

2. What will be done if the PRODUCT is not free from defects in materials and workmanship during the limited warranty period (“materially defective PRODUCT”)?

During the limited warranty period, the manufacturer’s authorized service representative will repair or replace at the manufacturer’s option, without charge, a materially defective PRODUCT. If the manufacturer repairs the PRODUCT, they may use new or refurbished replacement parts. If the manufacturer chooses to replace the PRODUCT, they may replace it with a new or refurbished PRODUCT of the same or similar design. The manufacturer will retain defective parts, modules, or equipment. Repair or replacement of the PRODUCT, at the manufacturer’s option, is your exclusive remedy. The manufacturer will return repaired or replacement products to you in working condition. You should expect the repair or replacement to take approximately 30 days.

3. How long is the limited warranty period?

The limited warranty period for the PRODUCT extends for ONE (1) YEAR from the date of purchase. If the manufacturer repairs or replaces a materially defective PRODUCT under the terms of this limited warranty, this limited warranty also applies to repaired or replacement PRODUCT for a period of either (a) 90 days from the date the repaired or replacement PRODUCT is shipped to you or, (b) the time remaining on the original one-year limited warranty; whichever is longer.

Limited warranty

4. What is not covered by this limited warranty?

This limited warranty does not cover:

- PRODUCT that has been subjected to misuse, accident, shipping or other physical damage, improper installation, abnormal operation or handling, neglect, inundation, fire, water, or other liquid intrusion; or
- PRODUCT that has been damaged due to repair, alteration, or modification by anyone other than an authorized service representative of the manufacturer; or
- PRODUCT to the extent that the problem experienced is caused by signal conditions, network reliability or cable or antenna systems; or
- PRODUCT to the extent that the problem is caused by use with non-AT&T accessories; or
- PRODUCT whose warranty/quality stickers, PRODUCT serial number plates or electronic serial numbers have been removed, altered or rendered illegible; or
- PRODUCT purchased, used, serviced, or shipped for repair from outside the United States of America or Canada, or used for commercial or institutional purposes (including but not limited to products used for rental purposes); or
- PRODUCT returned without a valid proof of purchase (see item 6 below);
-or-
- Charges for installation or setup, adjustment of customer controls, and installation or repair of systems outside the unit.

5. How do you get warranty service?

To obtain warranty service in the United States of America, visit

www.telephones.att.com/smb or call
1 (800) 222-3111. In Canada, call **1 (866) 288-4268**.

NOTE: Before calling for service, please review the user's manual; a check of the PRODUCT's controls and features may save you a service call.

Except as provided by applicable law, you assume the risk of loss or damage during transit and transportation and are responsible for delivery or handling charges incurred in the transport of the PRODUCT(s) to the service location. The manufacturer will return repaired or replaced PRODUCT under this limited warranty to you. Transportation, delivery or handling charges are prepaid. The manufacturer assumes no risk for damage or loss of the PRODUCT in transit. If the PRODUCT failure is not covered by this limited warranty, or proof of purchase does not meet the terms of this limited warranty, the manufacturer will notify you and will request that you authorize the cost of repair prior to any further repair activity. You must pay for the cost of repair and return shipping costs for the repair of products that are not covered by this limited warranty.

Limited warranty

6. What must you return with the PRODUCT to get warranty service?

You must:

- a. Return the entire original package and contents including the PRODUCT to the service location along with a description of the malfunction or difficulty; and
- b. Include a “valid proof of purchase” (sales receipt) identifying the PRODUCT purchased (PRODUCT model) and the date of purchase or receipt; and
- c. Provide your name, complete and correct mailing address, and telephone number.

7. Other limitations

This warranty is the complete and exclusive agreement between you and the manufacturer of this AT&T branded PRODUCT. It supersedes all other written or oral communications related to this PRODUCT. The manufacturer provides no other warranties for this PRODUCT. The warranty exclusively describes all of the manufacturer’s responsibilities regarding the PRODUCT. There are no other express warranties. No one is authorized to make modifications to this limited warranty and you should not rely on any such modification.

State/Provincial Law rights: This warranty gives you specific legal rights, and you may also have other rights which vary from state to state or province to province.

Limitations: Implied warranties, including those of fitness for a particular purpose and merchantability (an unwritten warranty that the PRODUCT is fit for ordinary use) are limited to one year from date of purchase. Some states/provinces do not allow limitations on how long an implied warranty lasts, so the above limitation may not apply to you. In no event shall the manufacturer be liable for any indirect, special, incidental, consequential, or similar damages (including, but not limited to lost profits or revenue, inability to use the PRODUCT or other associated equipment, the cost of substitute equipment, and claims by third parties) resulting from the use of this PRODUCT. Some states/provinces do not allow the exclusion or limitation of incidental or consequential damages, so the above limitation or exclusion may not apply to you.

Please retain your original sales receipt as proof of purchase.

Technical specifications

| | |
|---|----------------------------|
| RF frequency band | 1921.536MHz - 1928.448MHz |
| Channels | 5 |
| Operating temperature | 32°F - 122°F 0°C - 50°C |
| Headset base voltage (AC voltage, 60Hz) | 96Vrms - 127Vrms |
| Headset base voltage (AC adapter output) | 6VDC @300mA 7VDC @300mA |
| Headset voltage | 3.2VDC - 4.2VDC |
| Replacement battery | 3.7V 240mAH |

DECT 6.0 digital technology

Digital Enhanced Cordless Telecommunications (DECT) 6.0 is a new frequency band that transmits your voice across multiple channels. This technology provides superior quality of voice and sound, high protection against wiretapping and better range than 2.4 GHz and 5.8 GHz phone systems, while not interfering with wireless routers.

Operating range

This cordless headset operates within the maximum power allowed by the Federal Communications Commission (FCC). Even so, this headset and headset base can communicate over only a certain distance, which can vary with the locations of the headset base and headset, the weather, and the construction of your home or office.

Extended range and clarity

Experience the best in long-range coverage and clarity, provided by a unique antenna design and advances in noise-filtering technology. The TL7812 is a fully cordless DECT 6.0 headset offering a range of up to 500 feet. Open range test was performed by Wyle Laboratories, an independent commercial test facility. "Up to 500 feet" cordless headset range refers to the maximum open field range. Actual range may vary depending on intervening obstacles.

Sound level protection technology conforms to the current regulations and is used to filter out the loud and high-pitched noises.

Encrypted for added security

The 64 bit encryption adds an extra layer of security between your TL7812 headset and TL7812 base to keep your conversations private.

Index

A

- AC adapter 13, 16, 18, 68
- Adjust
 - corded handset audio 21
 - height of the lifter arm 23
 - sensitivity level 27
 - switch hook presser
 - position 23
- Alert tones 4
- Answer
 - a call in PHONE mode 38
- Anti-slip pad 25
- Attach lifter 22
- Auxiliary ring detector
 - installation 26
 - sensitivity adjust 27

B

- Base adapter 16, 18
- Battery charging 13
- Battery installation 12
- Behind the neck band 34–36

C

- Charging cradle 5, 13
- Corded handset audio adjust
 - switch 7
- Corded handset
 - connected 6, 16, 18, 20
- Corded phone
 - connection 15, 17

D

- Deregistration 46
- Dial tone 23, 24, 38
- DSL 11, 15, 17, 20

E

- Earbud 28
- Ear hook 29–31
- End
 - a call 39

H

- Head band 32–33
- Headset
 - alert tones 4
 - attachments 28–36
 - lights 2
 - operation 37–43
 - registration 44–45
 - ringer 39
- Headset base 15, 17
- Headset base lights 5

I

- Incoming call
 - answer in PHONE mode 38
- Internal ring detector 26

L

- Large lifter pad 25
- Light
 - headset 2
 - headset base 5

Index

Limited warranty 65–67

Listening volume 41

M

Magnetic charging
mount 5, 13

Maintenance 58

Multiple headsets use 42

Mute 42

N

Neck band 34–36

O

Operating range 68

Over the ear hook 29–31

Over the head band 32–33

P

Power off 37

Power on 37

Q

Quick reference guide

handset lifter 8–10

headset 2–4

headset base 5–7

R

Replace a headset 46

Ring detector 10, 26–27

Ringer 39

S

Sensitivity level 27

Small lifter pad 25

Speaking volume 41

Status light 10

Switch hook presser 23

T

Technical specifications 68

Temporary ringer silencing 40

Troubleshooting 47–57

U

USB port 6, 18

V

Volume control

listening volume 39, 41

ringer 39

speaking volume 41



www.telephones.att.com/smb

© 2012 Advanced American Telephones. All Rights Reserved.
AT&T and the AT&T logo are trademarks of AT&T Intellectual Property licensed to
Advanced American Telephones, San Antonio, TX 78219.

The Skype name is a trademark of Skype.
Microsoft Lync is a registered trademark of Microsoft Corporation.

Printed in China. Issue 2 AT&T 08/12