



*User Manual*  
**2.4 GHz Cordless  
Telephone/Answering  
System E2728B/E1128B**

---

**with Caller ID & Call Waiting**

---



Congratulations on your purchase  
of this AT&T product.  
Before using this telephone system, **you must**  
**read Important Safety Instructions**  
**on pages 45 to 47 of this manual.**

## **NEED HELP?**

Our representatives are here  
to help you with any questions concerning the  
operation of this product, available accessories,  
or any other related issues.

**Call Toll Free**  
**1 (800) 222-3111**  
**In Canada, Call**  
**1 (866) 288-4268**  
or visit our website at  
[www.telephones.att.com](http://www.telephones.att.com)

Model No.: AT&T E2728B/EI 128B  
Product Name: 2.4 GHz Cordless Telephone/Answering System  
Serial No.: SN: \_\_\_\_\_  
(found on the bottom of the telephone base)  
Purchase Date: \_\_\_\_\_  
Place of Purchase: \_\_\_\_\_

# IMPORTANT

## Information about Caller ID with Call Waiting

This product has a Caller ID with Call Waiting feature that works with service from your local phone service provider.

Caller ID with Call Waiting lets you see who is calling before you answer the phone, even when you're on another call.

**You may need to change your phone service to use this feature.** Contact your phone service provider if:

- You have both Caller ID and Call Waiting, but as separate services (you may need combined service).
- You have only Caller ID service, or only Call Waiting service.
- You don't subscribe to any Caller ID or Call Waiting services.

You can use this product with regular Caller ID service, and you can use this product's other features without subscribing to either Caller ID or combined Caller ID with Call Waiting service.

There are fees for Caller ID services, and they may not be available in all areas.

Depending on your service, you may see the caller's number, or the caller's name and number. This product can provide information only if both you and the caller are in areas offering Caller ID service, and if both telephone companies use compatible equipment. The time and date are sent by the service provider along with the call information.

**You must install and charge the battery before using the telephone.**

**STOP!**

**See page 7 for easy instructions.**

For customer service or product information, visit our web site at

**[www.telephones.att.com](http://www.telephones.att.com)**

or call 1-800-222-3111.

In Canada, call 1-866-288-4268.



**CAUTION:** To reduce the risk of fire or injury to persons or damage to the telephone, read and follow these instructions carefully:

- Use only Replacement Battery 3301 (SKU 91076. Part Number 80-5071-00-00).
- Do not dispose of the battery in a fire. Like other batteries of this type, it could explode if burned. Check with local codes for special disposal instructions.
- Do not open or mutilate the battery. Released electrolyte is corrosive and may cause damage to the eyes or skin. It may be toxic if swallowed.
- Exercise care in handling batteries in order not to create a short circuit, do not allow conductive materials such as rings, bracelets, or keys to touch the battery. The battery or conductor may overheat and cause harm.
- Charge the battery provided with or identified for use with this product only in accordance with the instructions and limitations specified in this manual.
- Observe proper polarity orientation between the battery and battery charger.

**Do not disassemble your telephone.** There are no user-serviceable parts inside. Refer for servicing to qualified service personnel.

User Manual

# 2.4 GHz Cordless Telephone / Answering System E2728B/EI I28B

with Caller ID & Call Waiting



## Table of contents

### Getting Started

Quick reference guide.....	2
Parts checklist .....	4
Before you begin.....	5
Telephone base installation.....	6
Battery installation & charging.....	7
Wall mounting.....	8
Belt clip & optional headset.....	9

### Telephone Operation

Cordless handset programming .....	10
Basic cordless handset operation ..	12
Base operation .....	13
Options while on calls.....	14
Call transfer .....	15

### Directory

Directory.....	16
Speed dialing .....	17
Entering names into directory.....	18
Entering numbers into directory ...	19
Directory search.....	20
Changing directory entries.....	21

### Caller ID Operation

How caller ID works .....	22
About names .....	23
To review your call log .....	24
To dial a call log entry.....	25

To delete call log entries.....	26
To add entries to phone directory ..	27

### Answering System Operation

Message capacity.....	28
Day and time announcements .....	29
Outgoing announcements.....	30
Announcement Only mode.....	31
Changing feature options.....	32
Message playback .....	33
Recording and playing memos .....	34
Message window displays.....	35
Remote access .....	36

### Appendix

Display screen messages, lights and tones .....	37
Troubleshooting .....	39
Important Safety Instructions .....	45
FCC Part 68 and ACTA .....	48
FCC Part 15 .....	49
Limited warranty .....	50
Technical specifications.....	53
Index.....	54
Remote access wallet card.....	55

# Quick reference guide

## Cordless Handset

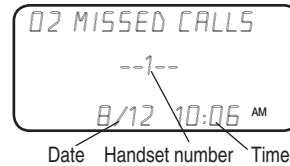

### PHONE/FLASH

Press to make or answer a call.  
During a call, press to receive an incoming call if Call Waiting is activated (see page 14).

### CID

While in menus, press to scroll down.  
When phone is not in use, press to display call log entries (see page 24).  
While entering names or numbers, press to delete last character entered.

### DIR

While in menus, press to scroll up.  
When phone is not in use, press to display directory entries (see page 20).  
While entering names, press to advance the cursor to the next space.

### SPEAKER

Press to activate cordless handset speakerphone.  
Press again to resume normal cordless handset use (see page 12).

### CHAN/DEL

During a call, press to switch to another channel if the call is noisy or unclear (see page 14).  
Press to delete displayed Caller ID entry (see page 26).  
While phone is not in use, press and hold to delete all Caller ID entries (see page 26).

### MENU/SEL/TRANSFER

Press to display menu, or to store a programming option (see pages 10-11).  
During a call, press to transfer a call (see page 15).

### OFF

During a call, press to hang up.  
During programming, press to exit without making changes (see pages 10-11).

### MUTE

During a call, press to mute microphone (see page 14).

### REDIAL/PAUSE

Press to display last number called (see page 12).  
While dialing or entering numbers into your directory, press to insert a 4-second dialing pause (see page 19).

## Quick reference guide

### Telephone Base

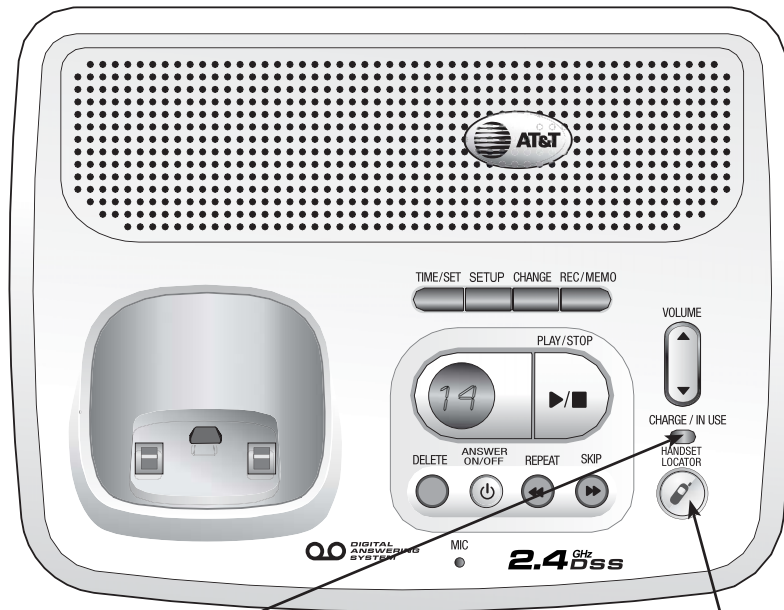

#### CHARGE/IN USE

Flashes when one of the cordless handsets is in use.  
On steady when the cordless handset is properly positioned to charge in the base.  
Flashes during an incoming call's ringing.

#### HANDSET LOCATOR

Press to page the cordless handsets. Press again, press OFF on cordless handset, or place cordless handset in the base or charger to cancel the page.



#### Answering System Controls (see pages 28-36)



Press to play or stop playing messages.

- ANSWER ON/OFF ..... Press to turn answering system on or off.
- DELETE ..... Press to delete a message during playback. Press and hold to delete all old messages when idle.
- TIME/SET ..... Press to review or set the answering system clock.
- SETUP ..... Press to review or change an outgoing announcement.  
Press again to review or change answering system options.
- CHANGE ..... Press to change a setup option.
- REC/MEMO ..... Press to record a memo.

Getting Started

## Parts checklist

Save your sales receipt and original packaging in case you need to ship your telephone for warranty service.



Telephone base

Cordless handsets

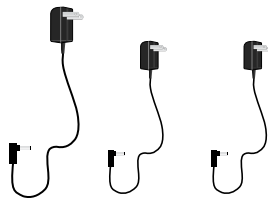

Power adapters

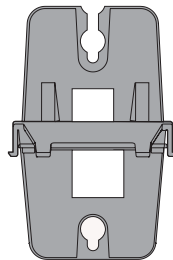

Wall mount bracket



Belt clips



Cordless handset chargers

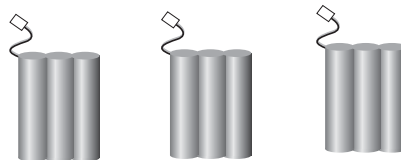

Battery Packs



Telephone line cord

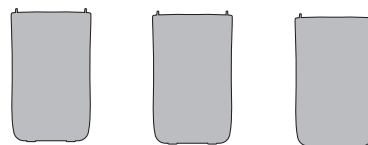

Battery compartment doors



## Before you begin

### Caller ID and Call Waiting

Caller ID with Call Waiting features in this telephone let you see who's calling before you answer the phone, even when you're on another call. These features require services provided by your local telephone company.

Contact your telephone service provider if:

- you have both Caller ID and Call Waiting, but as separate services (you may need combined service),
- you have only Caller ID service, or only Call Waiting service, or
- you currently do not have any Caller ID or Call Waiting services.

You can use this telephone with regular Caller ID service, and you can use its other features without subscribing to either Caller ID or combined Caller ID with Call Waiting service. There may be fees for these services, and they may not be available in all areas.

Caller ID features will work only if both you and the caller are in areas offering Caller ID service, and if both telephone companies use compatible equipment.

See Caller ID Operation on page 22 for more details about how these features work.

### Battery Pack for Cordless Handset

Use only the supplied rechargeable battery pack or AT&T replacement battery model 3301 (SKU 91076. Part Number 80-5071-00-00).

### Telephone Operating Range

The cordless telephone handset operates with the maximum power allowed by the Federal Communications Commission (FCC). This cordless handset and the telephone base unit can communicate over only a certain distance - which can vary with the locations of the base unit and the cordless handset, the weather, and the construction of your home or office.

If there is an incoming call but the cordless handset is out of range, the cordless handset might not ring - or if it does ring, the call might not connect well when **PHONE** is pressed. Move closer to the base, then press **PHONE** to answer the call.

If you move out of range during a telephone conversation, you might hear noise or interference from the cordless handset. To improve reception, move closer to the telephone base unit.

If you move out of range without pressing **OFF**, your telephone will be left "off the hook" and the line will be busy. To hang up properly, walk back toward the telephone base unit while periodically pressing **OFF** until the call is disconnected.

If you experience noise or interference while on a call, press the **CHAN** button until you find a clearer channel.

*Getting Started*

## Telephone base installation

Install the telephone base as shown below. Choose a location in a central location within the home and:

- Away from any other cordless (wireless) device such as cordless telephones, 802.11 wireless router (for example, WiFi).
- Away from other electronic equipment, microwave oven, television, computer, etc.
- If you need to install your phone within the same room as other cordless phones or wireless products, you may need to select a different channel for your router and or change the channel on your phone's handsets (see page 14).

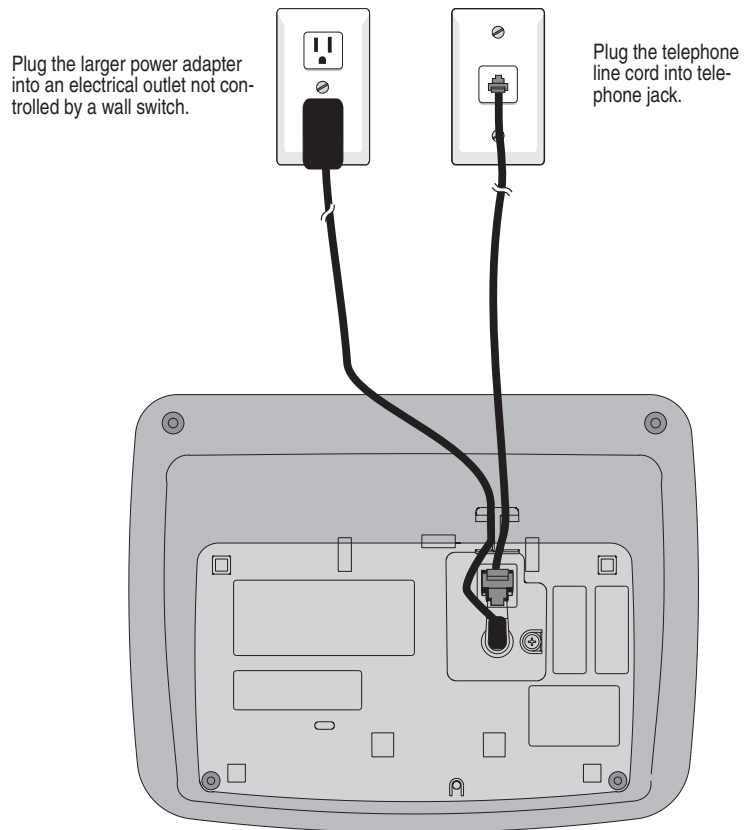

**NOTE:** Use only the power adapter supplied with this product. If you need a replacement, call 1-800-222-3111. In Canada, call 1-866-288-4268. Be sure to use an electrical outlet not controlled by a wall switch.

Getting Started

## Battery installation & charging

After battery installation, place the cordless handset in the base or charger and allow to charge for at least 16 hours before use. You can keep the battery charged by returning the cordless handset to the base or charger after each use. When the battery is fully depleted, a recharge takes about 16 hours. The talk time on a fully charged battery is about four hours depending on environmental conditions, and the standby time is approximately five days. Actual battery life will depend on usage conditions, and age of battery.

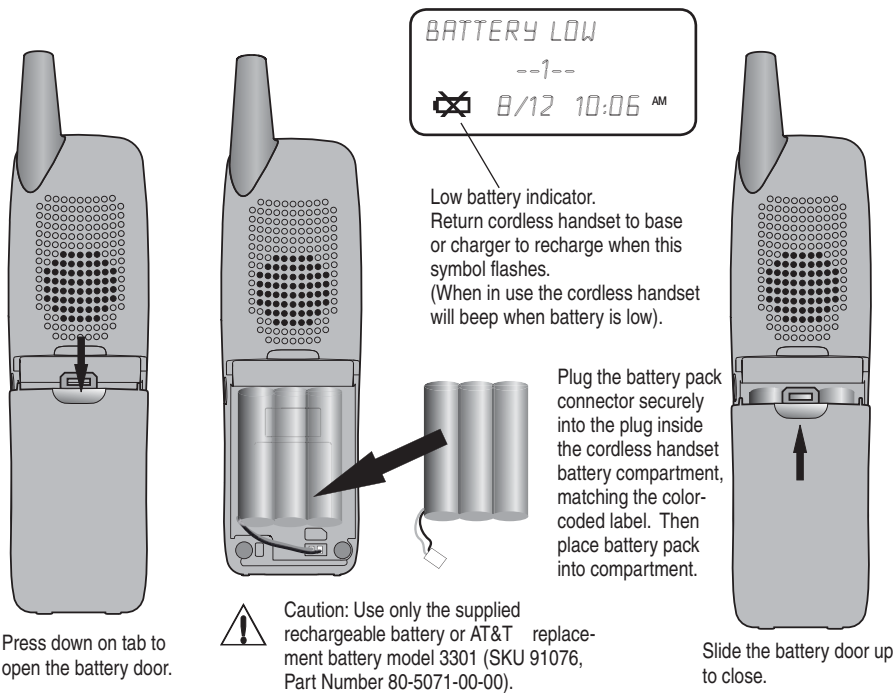

Plug charger power adapter into jack on underside of charger, then plug adapter into electrical outlet.

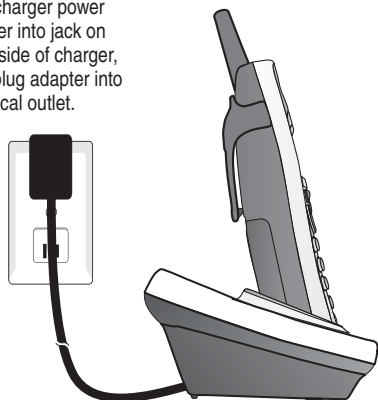

Place cordless handset in base or charger to charge for at least 16 hours before first use.



## Getting Started

# Wall mounting

The base can be installed on any standard phone outlet as shown below. Choose a location in a central location within the home, away from electronic equipment such as personal computers, computer routers, television sets or microwave ovens. Avoid excessive heat, cold, dust or moisture.

1) Connect telephone line cord and AC power cord to telephone jack and wall jacks, as shown on page 6.

2) Install wall mount bracket onto set. First put the two front wall-mount-bracket tabs into the front notches on bottom of telephone base, then squeeze the rear tabs of the wall mount bracket as you insert them into the rear notches on the bottom of the telephone base.

**i** **NOTE:** To disassemble the wall mount bracket, squeeze the rear tabs while lifting up the wall mount bracket back and away from the telephone base.

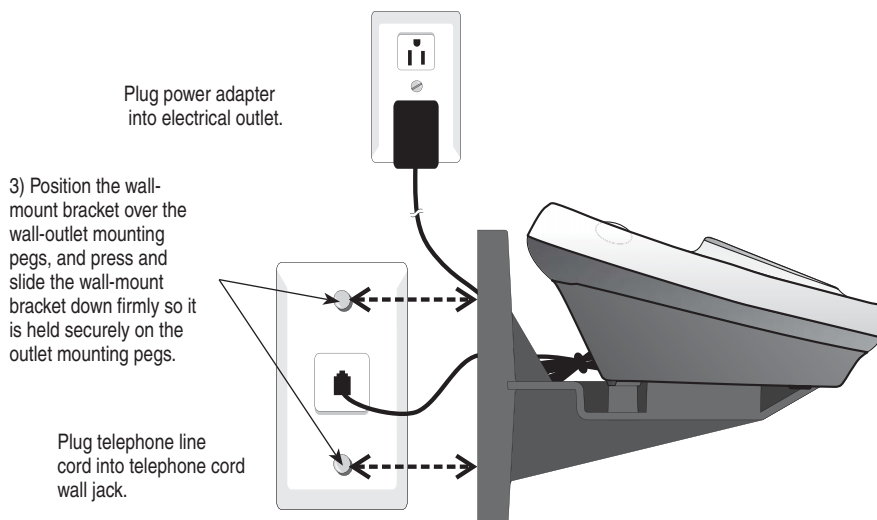
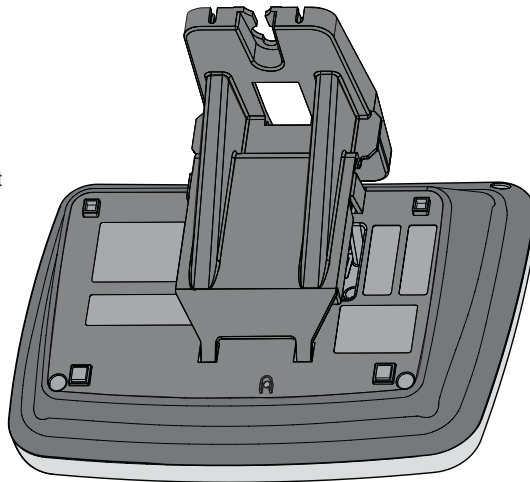

Getting Started

## Belt clip & optional headset

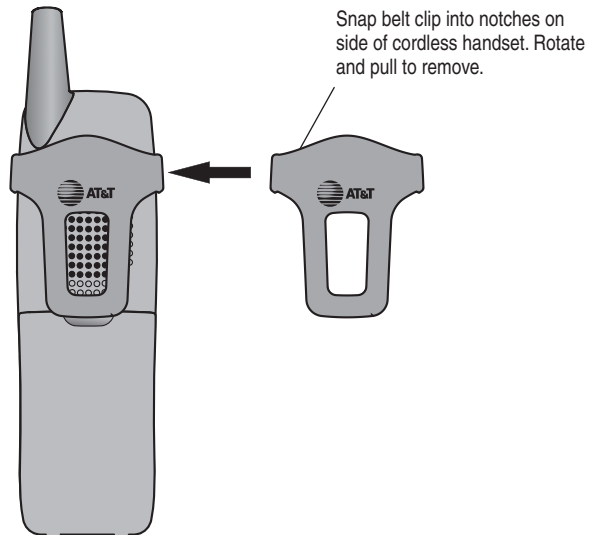

For hands-free telephone conversations, you can use any industry standard 2.5 mm headset (purchased separately). For best results, use an AT&T 2.5 mm headset.



## Telephone Operation

### Cordless handset programming

Each cordless handset operates as an individual unit. The ringer sound, ringer volume, date/time, dial mode and language must be programmed separately for each cordless handset. Follow the steps below to program the cordless handset. To stop at any time, press **OFF**.

#### Choose cordless handset ringer sound

1. Press **MENU** to begin programming.
2. Press **▲** or **▼** until the screen displays *RINGER:* and the current setting.
3. Press **SELECT** to start changing current setting.
4. Press **▲** or **▼** to display 1, 2, 3, or 4. You will hear a sample of each ringer sound.
5. Press **SELECT** to choose displayed ringer sound and exit.

#### Choose cordless handset ringer volume

1. Press **MENU** to begin programming.
2. Press **▲** or **▼** until the screen displays *RINGER VOLUME*.
3. Press **SELECT** to start changing current setting.
4. Press **▲** or **▼** to display 1, 2, 3, or OFF. You will hear a sample of each ringer volume.
5. Press **SELECT** to choose displayed ringer volume and exit.

**i** **NOTE:** If the cordless handset ringer is turned off, the screen will display *RINGER OFF* when the cordless handset is idle (not in use). If there are any un-reviewed calls, the screen will display *XX MISSED CALLS* instead of *RINGER OFF*.

#### Set cordless handset display date and time

1. Press **MENU** to begin programming.
2. Press **▲** or **▼** until the screen displays *DATE/TIME*.
3. Press **SELECT** to view or change date and time.
4. Press **▲** or **▼** to start changing month in the date and time line at the bottom of the display, then press **SELECT**.
5. Repeat Step 4 to set day, hour, minute, and AM/PM.
6. Press **SELECT** to save selection and exit.

**i** **NOTE:** You can choose to set the time manually, or you can allow it to be set automatically with incoming Caller ID information. The time will be set automatically only if you subscribe to Caller ID service provided by your local telephone company (see page 5). The date and time for the answering machine need to be set separately (see page 29).

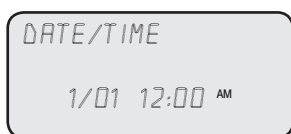
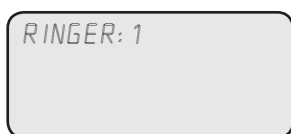

## Cordless handset programming

### Choose dial mode

The dial mode defaults to TONE. If you do not have touch tone service, you'll need to change the setting to pulse by following these steps:

1. Press **MENU** to begin programming.
2. Press **▲** or **▼** until the screen displays *DIAL MODE:* and the current setting.
3. Press **SELECT** to start changing current setting.
4. Press **▲** or **▼** to display TONE or PULSE.
5. Press **SELECT** to choose displayed dial mode and exit.

DIAL MODE: TONE

### Clear Voice Mail (for all cordless handsets)

If you subscribe to voice mail service provided by your local telephone company, you will be alerted to new voice mail messages in two ways. When you press **PHONE**, the dial tone will toggle on and off (stutter tone) and you will receive a text message on all cordless handsets. To manually remove the stutter tone and **MESSAGE WAITING** message on all cordless handset screens:

- Press **MENU**.
- Press **▲** or **▼** until the screen displays **MESSAGE WAITING**.
- Press **SELECT** then **▲** or **▼** to choose **YES**.
- Press **SELECT** to select **YES** and exit.

MESSAGE WAITING

**i NOTE:** This only turns off the displayed message on all cordless handset screens; it does not delete your voice mail message(s). Use this feature when the phone indicates there is voice mail when you have none or you have accessed your voice mail from a different phone line (while away from home). If there actually is a new voice mail message, your local telephone company will continue to send the message which turns the display message back on.

CLEAR? YES

### Choose cordless handset display language

Your phone will default to English handset screen displays. If you wish to change them to Spanish, follow these steps:

1. Press **MENU** to begin programming.
2. Press **▲** or **▼** until the screen displays *LANGUAGE*.
3. Press **SELECT** to start changing current setting.
4. Press **▲** or **▼** to display ENGLISH or ESPANOL .
5. Press **SELECT** to choose displayed language and exit.

LANGUAGE

## Telephone Operation

### Basic cordless handset operation



#### **i** NOTES:

1. Only one cordless handset can be on a call at a time. If another cordless handset attempts to join a call, its screen will display OTHER HANDSET ON and then OR OUT OF RANGE.
2. Use the speakerphone feature if more than one person in your household wishes to be on an active call at the same time. Or, use the call transfer feature (see page 15) to transfer an active call from one system handset to another.



- i** NOTE: This will only turn off the cordless handset ringer temporarily that the OFF key was pressed on. Other cordless handsets and telephone base will continue to ring normally.

#### Making and answering calls

To answer an incoming call, press **PHONE** (or **SPEAKER**, or any dial pad key). To make a call, press **PHONE** or **SPEAKER**, then dial a number. Press **OFF** or place the cordless handset back in the base or charger to hang up.

To preview numbers before dialing, enter numbers first, then press **PHONE** or **SPEAKER** to dial. Press **▼** at any time to make corrections as you are entering numbers.

The screen displays the elapsed time as you talk (in hours, minutes and seconds).

**i** NOTE: The elapsed time format is in minutes and seconds "MM:SS" until one hour has elapsed, then it will change to hours, minutes and seconds "H:MM:SS".

Pressing **FLASH** to access service from your local telephone service provider will not affect the elapsed time. The elapsed time will not be carried over to the other cordless handset on a transferred call.

#### Hands-free speakerphone calls

To answer a call, press **SPEAKER**. To make a call, press **SPEAKER**, then dial a number. During a call you can press **SPEAKER** to toggle between hands-free speakerphone and normal cordless handset use. Press **OFF** to hang up.

#### Last number redial

Press **REDIAL** on the cordless handset to display the last number called (up to 32 digits). To dial the number displayed, press **PHONE** or **SPEAKER**. Or, after pressing **PHONE** or **SPEAKER**, press **REDIAL** to call the last number dialed.

To delete this number, press **REDIAL** twice when the phone is not in use. This will clear the redial memory and leave it blank.

#### Temporary ringer silencing

Press **OFF** while the phone is ringing to temporarily turn off the ringer. The next phone call will ring normally. You can answer the call or let the caller leave a message.

This will silence the ringer without disconnecting the call. If your answering system is on, the caller will be asked to leave a message.





## Telephone Operation

### Base operation

#### Handset Locator

Press to page all cordless handsets for up to 60 seconds. Press again, press **OFF** on cordless handset, or place cordless handset in the base to cancel the page.

- i NOTE:** Pressing OFF on any cordless handset will cancel the page on that cordless handset, but will not cancel the page.
- i NOTE:** If one of the cordless handsets is charging in the base, pressing **HANDSET LOCATOR** does not generate a paging tone.
- i NOTE:** Placing the cordless handset in the base or charger will cancel the page on that cordless handset, but will not cancel the page.

## Telephone Operation

### Options while on calls

#### Volume control

While on a call, press the **VOLUME** buttons on the cordless handset to adjust listening volume. To adjust the speakerphone listening volume, press **SPEAKER**, then press the **VOLUME** buttons.

#### Call waiting

If you have Call Waiting service, you will hear a beep if someone calls while you are already on a call. Press **FLASH** to put your current call on hold and answer the new call. You can press this button anytime to switch back and forth between calls.

#### Mute

You can press **MUTE** to silence the microphone while on a call. You will be able to hear the caller, but your caller will not be able to hear you until you press **MUTE** again to resume speaking. When you press **OFF** to hang up the phone, the feature will be canceled.

#### Temporary tone dialing

If you have pulse dial (rotary) service, you can temporarily switch to touch tone dialing during a call by pressing **TOUCH TONE**. This can be useful if you need to send tone signals to access answering systems or long-distance services. After you hang up or press **FLASH** the phone automatically returns to pulse dial (rotary) service.

#### Channel selection

During a call, if you hear clicks and pops, or if the speech sometimes fades, press **CHAN** on the handset to scan for a clearer radio channel between cordless handset and base.



## Call transfer

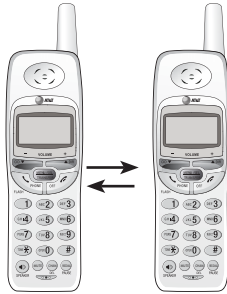

### Call transfer

During a conversation, you can transfer the call to another cordless handset.

- Press **TRANSFER** to transfer the external call to another cordless handset. You will see **ENTER HANDSET #**. After entering the cordless handset number to which you want to transfer the call, your cordless handset will display **CALL TRANSFERRED** and the selected handset will begin ringing.
- To answer the call, press **PHONE** or **SPEAKER**.

#### NOTES:

1. Before the transferred call is answered, the person at cordless handset that originated the transfer can press **PHONE** or **SPEAKER** to cancel the transfer function and resume the external call.
2. If the transferred call is not answered within 30 seconds, the cordless handset that originated the transfer will start ringing and show **TRANSFERRED CALL**. If **PHONE** or **SPEAKER** is not pressed within another 30 seconds, the external call will end automatically.
3. If the destination cordless handset cannot be found, the cordless handset that originated the transfer will generate an error tone and continue the external call automatically.
4. This unit does not have an intercom function. The cordless handsets cannot communicate with each other.



## Directory

### Memory capacity

---

Each cordless handset has its own directory. Each directory can store up to 30 entries (including nine speed dial locations). Each entry can contain a number up to 24 digits, and a name up to 15 letters long. A convenient search feature can help you find and dial numbers quickly (see page 20).

### Speed dialing

---

On the cordless handset, the nine memory locations (1 through 9) are reserved for numbers you dial frequently. These numbers can be dialed with two button presses (see next page).



**NOTE:** If all memory locations are in use, an error tone will sound with MEMORY FULL message when you attempt to enter a number. This means the memory is full, and you will not be able to store a new number until you delete an existing one.

**i** **NOTE:** If all memory locations are in use, an error tone will sound when you attempt to enter a number. This means the memory is full, and you will not be able to store a new number until you delete an existing one.

**1**  **MENU**



**2**  



**3**  **SELECT**



**4** 



(See Steps 3-7 on page 18-19).

## Directory



### Speed dialing

On the cordless handset, the numbers called most frequently can be stored in speed dial locations 1-9 and dialed with only two button presses.

You can enter 9 Speed Dial numbers of up to 24 digits. Each number is stored in a one-digit speed dial location (1-9).

**i** **NOTE:** The Speed Dial feature occupies up to nine of the thirty memory locations in the Directory. For example, if there are only five Speed Dial entries, then up to 25 entries can be stored in the Directory. If there are already 30 entries in the Directory, no new Directory and Speed Dial entries can be stored in memory until some of the existing ones are deleted.



#### To enter a Speed Dial number

1. Press **MENU** to begin programming.
2. Press  to display *SPEED DIAL*.
3. Press **SELECT**.
4. Press dial pad to choose speed dial location (1-9).
5. Enter a name up to 15 characters (see page 18), then press **SELECT**.
6. Enter a telephone number up to 24 digits (see page 19), then press **SELECT**.
7. Choose distinctive ringing (yes or no) by pressing  or . If you choose Yes (and if you have Caller ID service), a different ringing style will alert you when this person calls.
8. Press **SELECT** to store the number. You will hear a confirmation tone.

#### To call a Speed Dial number

To use speed dialing, press and hold a dial pad button (1-9) to display the number and name stored in that speed-dial location, then press **PHONE** or **SPEAKER** to dial.

#### To edit or delete a Speed Dial number

Press and hold a dial pad button (1-9) to display the entry you want. Press **SELECT**, then press  or  until the option you want is displayed (see page 21).

**i** **NOTE:** If all memory locations are in use, an error tone will sound when you attempt to enter a number. This means the memory is full, and you will not be able to store a new number until you delete an existing one.

**1**  **MENU**



**2**  **SELECT**



**3** 



*Directory*





## Entering names into directory

### To enter a name

Use the dial pad and the chart below to enter a name (up to 15 characters). Each press of a particular key causes characters to be displayed in the following order:

Dial Key	Characters by number of key presses					
	1	2	3	4	5	6
1	1					
2	A	B	C	2		
3	D	E	F	3		
4	G	H	I	4		
5	J	K	L	5		
6	M	N	O	6		
7	P	Q	R	S	7	
8	T	U	V	8		
9	W	X	Y	Z	9	
0	0					
*	*					
#	&	'	,	-	.	#

### Options while entering names:

- Press the  button to move the cursor to the right. Press  twice to enter a space.
- Press  to erase letters if you make a mistake.
- Press  repeatedly to enter an ampersand (&), apostrophe ('), comma (,) hyphen (-), period (.), or pound sign (#).

When finished, press **SELECT**.

**4**  **SELECT**

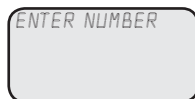

**5** 

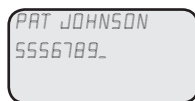

**6**  **SELECT**



**7**  **SELECT**

*Directory*

## Entering numbers into directory



### To enter a number

Use the dial pad to enter up to 24 digits. When the number is complete, press **SELECT**.

### Options while entering numbers:

- Press  to erase digits if you make a mistake.
- Press **PAUSE** to enter a 4-second dialing pause.

### To assign a distinctive ring

Press  or  to select Y (yes) or N (no). If you choose Yes (and if you have Caller ID service), a different ringing style will alert you when this person calls.

Press **SELECT** to choose the option displayed (Y or N) and store this entry in the directory.

A  appears in the display of each entry that has been assigned a distinctive ring.

1   **DIR**

DIRECTORY

2  

ADAM  
5551234

To display first entry

BETH  
5554321

To scroll name by name

Or

JOHN  
5550123



To search alphabetically

## Directory

### Directory search

Follow the steps on the left to browse through the directory or search to find a specific entry. You can press **OFF** anytime to exit the directory.

#### To browse through the directory

To browse, press **DIR** then press  or  to scroll through all entries one by one.

A  appears in the display of each entry that has been assigned a distinctive ring (see page 19).

 **NOTE:** When reviewing the Directory entries, all entries (including those in the Directory and in the Speed Dial) are displayed in alphabetical order. The entries in the Speed Dial are identified by its Speed Dial number (01-09) in the lower right corner of the screen.

#### To search alphabetically

To shorten your search, press **DIR**, then use the telephone dial pad to enter the first letter of a name, then press  to scroll forward until you find the desired name.

Press dial pad buttons once for the first letter, twice for the second, three times for the third, as shown on page 18.

For example, press **5 (JKL)** once to find JENNIFER, twice to find KEVIN, or three times to find LINDA.

#### To call a displayed number

When the entry you want is displayed, you can press **PHONE** or **SPEAKER** to dial it immediately.



**1**  **DIR**



**2**  

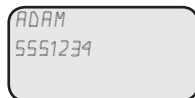

**3**  **SELECT**







 



Press **SELECT** to choose blinking option

## Directory

### Changing directory entries

When any entry is displayed, press **SELECT** to see options. Press  or  to highlight the option you want (blinking text), then press **SELECT** again to select it.

#### To edit an entry

When *EDIT* is blinking, press **SELECT**. You can change the name and number (or distinctive ring setting on the cordless handset) by following the steps described on pages 18-19.

#### To delete an entry

Press  until *ERASE* is blinking, then press **SELECT** to display a confirmation screen (*ERASE NO YES*).

To delete the entry, press  to highlight YES, then press **SELECT**.

To cancel the procedure and leave the entry intact, press  to highlight NO, then press **SELECT**.

 **NOTE:** Each cordless handset has its own directory. Deleting a directory entry from one cordless handset does not automatically delete the same entry from all other cordless handsets.

#### To make an entry into a Speed Dial entry

Press  until *SPEED* is blinking, press **SELECT**, then dial a memory location (1-9) to transfer this entry to your Speed Dial directory.

 **NOTE:** If you use a memory location (Speed dial memory) that is already assigned to a different entry in the directory, that entry will remain in the directory, but will no longer be a Speed Dial number.



# Caller ID Operation

## How Caller ID works

If you subscribe to Caller ID service provided by your local phone company, information about each caller will be displayed between the first and second ring.

An asterisk, means same caller has

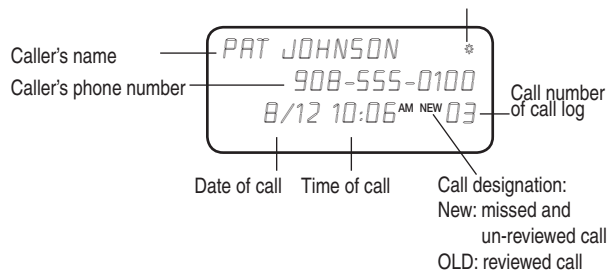

Separate Caller ID logs are kept in the cordless handsets. Information about the last 30 incoming calls is stored in each call log. You can review the call log to find out who has called, return the call without dialing, or transfer the caller's name and number into your phone directory.

Each incoming call is numbered. The most recent call is assigned the highest number. When the call log is full, the oldest call information is deleted to make room for new incoming call information.

If you answer a call before the information appears on the screen, it will not be saved in your call log.

**NOTE:** Caller ID features will work only if both you and the caller are in areas offering Caller ID service, and if both telephone companies use compatible equipment.

**NOTE:** Each cordless handset's call log is independent of the other cordless handset's call logs. For example, when you delete one or all call log entries from one cordless handset, the information on all other cordless handsets does not change.

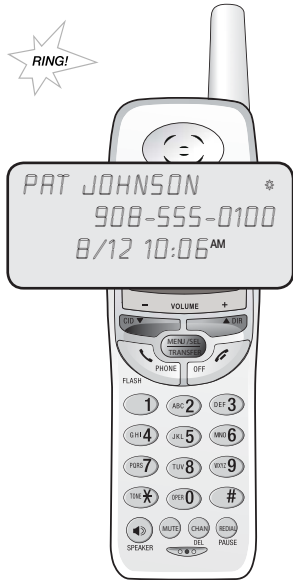

## Caller ID Operation

### About names

Names of callers will be displayed only if this information is provided by your local telephone company.

If the telephone number of the person calling exactly matches a number in your directory, the name that appears on the screen will match the name that you entered into your directory.

(Example: If Christine Smith calls, her name will appear as CHRIS if this is how you entered it into your directory.)

**i** **NOTE:** The number shown by your caller ID will be in the format sent by the phone company. The phone company usually delivers ten-digit phone numbers (area code plus phone number). If the telephone number of the person calling does not exactly match a number in your directory, the name will appear as delivered by the phone company. For example if the phone company includes the area code and the directory number does not, the name will appear as delivered by the phone company.

There are also occasions when other information or no information is displayed for various reasons:

On-Screen Message	Reason
<i>PRIVATE NAME</i>	Caller prefers to remain anonymous
<i>PRIVATE CALLER</i>	Caller name and telephone number not revealed at caller's request.
<i>UNKNOWN NAME</i>	Your local telephone company is unable to determine the caller's name.
<i>UNKNOWN CALLER</i>	Your local telephone company is unable to determine the caller's name and telephone number. Calls from other countries may also generate this message.

**i** **NOTE:** When in idle mode, the screen will show **XX MISSED CALLS** and the current date and time.

### Missed calls

When a handset is not being used, its screen will show the number of missed calls and the current date and time. **XX MISSED CALLS** are calls that have not been reviewed at that handset. When a **NEW** call log entry is reviewed, the number of missed calls at that handset decreases by one. The number of **MISSED CALLS** on the other cordless handset(s) remains unchanged until they are reviewed on those cordless handsets.

**1**  **CID**

PAT JOHNSON  
908-555-0100  
8/12 10:06 AM NEW 03

**2**  

CHRIS WILLIAMS  
908-555-1234  
8/12 9:53 AM NEW 02

**3**  

MARK CLAYTON  
908-555-5678  
8/12 9:12 AM NEW 01

**4**  **PHONE**

PHONE ON 00:10  
9085555678

To dial this number



*Caller ID Operation*

## To review your call log

The call log review displays the Caller ID in reverse chronological order, with the latest one (the one with the highest number) first.

When the phone is not in use, press **CID** to display information about the most recent caller.

### To review your call log

Press  to scroll backward (display older calls) or  to scroll forward (display newer calls). The highest call number is the most recent call received.

### To return a call

Press **PHONE** or **SPEAKER** to call the number currently displayed (see page 25 for important dialing options).

### Other options

Press **SELECT** at any Caller ID screen to see options (Dial or Program; see pages 25-27).

### New and Old calls

Each Caller ID entry in the call log will be designated **NEW** until you have reviewed the call. After a call has been reviewed, it will be designated as **OLD**.

**1**  **CID**



**2**  **PHONE**

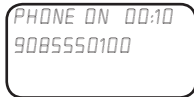

Or

**1**  **CID**

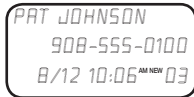

**2**  **#**



**3**  **PHONE**



*Caller ID Operation*

**To dial a call log entry**

When any Caller ID screen is displayed, press **PHONE** or **SPEAKER**, or press **SELECT** then  and **SELECT** to dial the number exactly as it appears on the screen.

**Dialing options**

Caller ID numbers may appear with an area code that may not be required for local calls.

If the number displayed is not in the correct format, you can change how it is dialed. Press  repeatedly to see dialing options. With each button press, a new option will be displayed. Press **PHONE** or **SPEAKER** to dial when the number appears in the proper format for your area.

**Example:**

**CID**..... Number displayed as 908-555-0100

 twice ..... Number changes to 555-0100 (drops "1" + area code)

**PHONE** or **SPEAKER**.....Dials 555-0100

**1**  **CID**

PAT JOHNSON  
908-555-0100  
8/12 10:06 AM NEW 03

**2**  

CHRIS WILLIAMS  
908-555-1234  
8/12 9:53 AM NEW 02

**3**  **DEL**

MARK CLAYTON  
908-555-5678  
8/12 9:12 AM NEW 01

Or

27 MISSED CALLS  
--1--  
1/01 12:00 AM

**1**  **DEL**

ERASE ALL NO YES  
1/01 12:00 AM

**2**  

ERASE ALL NO YES  
1/01 12:00 AM

**3**  **SELECT**



--1--  
1/01 12:00 AM

Call log cleared

### Caller ID Operation

## To delete call log entries

### To delete a single call log entry

Press **CID** to display the first Caller ID listing. Use the  or  keys to find the entry you want to delete, then press **DEL**. When the entry is deleted, the next oldest record is displayed.

### To delete all call log entries

To clear your call log completely, press and hold **DEL** while the phone is idle (not in use). This will display a confirmation screen asking if you want to erase all entries in the Caller ID log. If you select **YES**, the call log will be cleared and the screen will return to normal standby display, showing no missing calls.

 **NOTE:** Each cordless handset has its own call log. When you delete one or all call log entries from one cordless handset, the information on all other cordless handsets will not be affected.

### Caller ID Operation

## To add entries to phone directory

When any Caller ID screen is displayed, follow the steps at left to enter it into your phone directory.

Both the caller's name and telephone number will be entered as they appear in the call log. At steps 3-4, you can make any changes to the name or number by using the  button to erase characters, or using the dial pad to enter new ones (see pages 18-19 for instructions).

When the number is stored, the screen returns to the call log display. The entry copied to your phone directory remains in the call log until deleted.

#### 1 CID

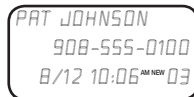

#### 2 SELECT



#### 3 SELECT

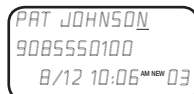

Edit name as desired

#### 4 SELECT

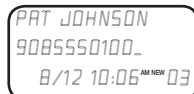

Edit number as desired

#### 5 SELECT

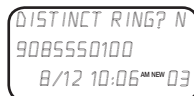

#### 6 SELECT

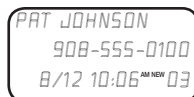

Entry added to phone directory

# Answering System Operation

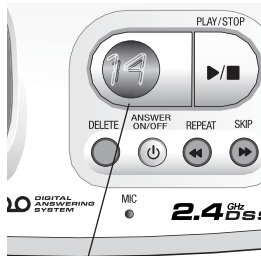

Message window

Number of messages (or, during playback, message number currently playing).

## Message capacity

The answering system can record up to 99 messages, depending on the length of each message. Individual messages can be up to four minutes long, and the maximum recording time is 15 minutes. Messages will remain available for replay until they are deleted.

Press to review or change an outgoing announcement (see page 30). Press again to review or change answering system options (see page 32).

Press to review or set clock (see page 29).

Message window.

Press to delete message. Press and hold to delete all old messages (see page 33).

Press to turn answering system on or off.

Press to repeat message, hold to slow playback, press twice to play previous message (see page 33).

Press to skip message, hold to speed up playback (see page 33).

Press to select or change a setup option (see page 32).

Press to record a memo (see page 34).

Press to adjust volume during message playback (see page 33).

Press to start or stop message playback (see page 33).

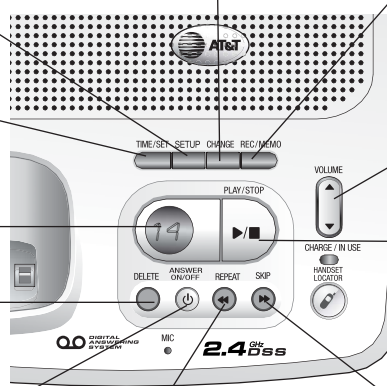



## Answering System Operation

# Day and time announcements

## To set day and time

Before playing each message, the answering system announces the day and time the message was received.

Before using the answering system, you should follow the steps on the left to set the day, time and year, so messages are dated correctly. If you subscribe to Caller ID service, the day and time will be set automatically, in which case you only need to set the year.

The system uses voice prompts to guide you. Each time you press **CHANGE**, the day, hour, minute or year advances by one. When you hear the correct setting, press **TIME/SET** to move to the next setting.

## To check day and time

You can press **TIME/SET** at any time to hear the current day and time without changing it.

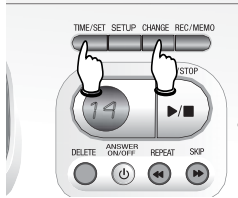

1.  Press **TIME/SET**

The system announces the current clock setting, then announces "To begin setting the clock, press **TIME/SET** then press **CHANGE** to change the setting or press **TIME/SET** to continue."

2.  Press **TIME/SET**

3.  Press **CHANGE**

until the system announces the correct day, then press **TIME/SET**.

4.  Press **CHANGE**

until the system announces the correct hour, then press **TIME/SET**.

5.  Press **CHANGE**

until the system announces the correct minute, then press **TIME/SET**.

6.  Press **CHANGE**

until the system announces the correct year, then press **TIME/SET**. The system announces the current clock setting.

 **NOTE:** Press and hold **CHANGE** to advance the minute or year by increments of 10 (the year can be set from 2000 to 2039). If you accidentally pass the current year, continue to hold the **CHANGE** key until it passes the year 2039 and returns to the year 2000, then press **CHANGE** until the correct year is announced.

 **NOTE:** Caller ID provides the time and date. Set the year so that the day of the week can be calculated from the Caller ID information. After you set the time once, it will thereafter be set automatically with incoming Caller ID information. The time will be set automatically only if you subscribe to Caller ID service provided by your local telephone company (see page 5).

## Answering System Operation

### Outgoing announcements

Outgoing announcements are the messages callers hear when calls are answered by the answering system.

The phone is pre-programmed with announcements for normal (Answer and Record) mode and for Announcement Only mode (see page 31). If the phone is set up to record messages (Announcement Only mode is turned off), the phone answers calls with a pre-recorded announcement that says "Hello. Please leave a message after the tone." You can use this announcement, or replace it with a recording of your own voice (see the following steps).

#### To record your outgoing announcement

Press **SETUP** until you hear "Announcement. Press **PLAY** or press **RECORD**. To continue setup, press **SETUP**." Then press **REC/MEMO** and begin speaking after you hear "Record after the tone. Press **STOP** when you are done." Speak facing the telephone base from about nine inches away. Press **PLAY/STOP** when you are done.

Elapsed time (in seconds) will be shown in the message window as you record. You can record an announcement up to 90 seconds long. Announcements less than three seconds long will not be recorded.

#### To delete your outgoing announcement

Press **SETUP** until you hear "Announcement. Press **PLAY** or press **RECORD**. To continue setup, press **SETUP**." Then press **PLAY/STOP** to begin playback. Press **DELETE** during playback to delete your announcement.

When your announcement is deleted, calls will be answered with the pre-programmed announcement described above.

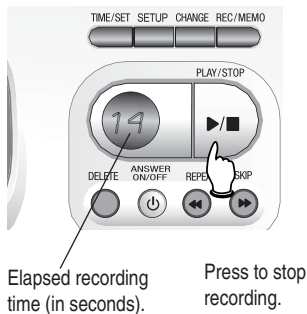

#### 1. **SETUP**

"Announcement, press **PLAY** or press **RECORD**. To continue setup, press **SETUP**."

#### 2. **(PLAY/STOP)**

(Plays announcement previously recorded).

Or

#### 2. **REC/MEMO**

"Record after the tone, press **STOP** when you're done."

#### 3. Speak into microphone.



#### 4. **(PLAY/STOP)**

(Announcement is played back).

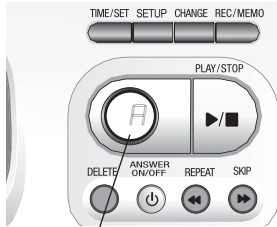

"A" is displayed when  
Announcement Only is activated.

**1.  SETUP**

 "Announcement  
only, record no  
messages. To  
change the setting  
press CHANGE."

**2.  CHANGE**

 "Off"

**3.  CHANGE**

 "On"

**4.   (PLAY/STOP)**

 **Beep**  
(Option selected).

*Answering System Operation*

## Announcement Only mode

In Announcement Only mode, callers hear an announcement but cannot leave messages.

### To turn Announcement Only on or off

Press **SETUP** repeatedly until you hear "**Announcement only, record no messages. To change the setting press CHANGE.**" Then press **CHANGE** until you hear the option you want (on or off). Press **PLAY/STOP** to store your selection and exit, or press **SETUP** again to modify other features.

### To record your outgoing announcement

When Announcement Only is turned on, calls are answered with a pre-recorded announcement that says "**We're sorry, messages to this number cannot be accepted.**" You can use this announcement, or replace it with a recording of your own voice.

After turning on the Announcement Only feature, follow the steps on page 30 to record your announcement. Callers will hear this announcement only when the Announcement Only feature is turned on. Otherwise they will hear the standard announcement asking them to leave a message.

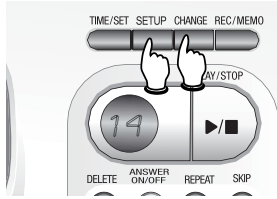

## Answering System Operation

### Changing feature options

You can change how the answering system operates. Press **SETUP** repeatedly to hear each feature. Press **CHANGE** when you hear the feature you want to modify.

#### Feature options (Default settings underlined>)

System announces:	Feature description:
"Announcement. Press <b>PLAY</b> or press <b>RECORD</b> . To continue setup, press <b>SETUP</b> ." Options: [record announcement]	Press <b>REC/MEMO</b> to record your outgoing announcement (see page 30). Press <b>STOP</b> to stop recording.
"Remote access code. To change the setting press <b>CHANGE</b> ." Options: [enter 2-digit code] <u>19</u>	Enter a two-digit number (10-99) for remote access from another phone (see page 36).
"Message alert. To change the setting press <b>CHANGE</b> ." Options: On / <u>Off</u>	When on, the telephone beeps every 10 seconds when you have new messages.
"Announcement only, record no messages. To change the setting press <b>CHANGE</b> ." Options: On / <u>Off</u>	When on, callers hear an announcement but cannot leave messages (see page 31).
"Base ringer. To change the setting press <b>CHANGE</b> ." Options: <u>On</u> / Off	Choose this option to turn the base ringer on or off (does not affect cordless handset).
"Number of rings. To change the setting press <b>CHANGE</b> ." Options: 2 / <u>4</u> / 6 / Toll Saver	Choose number of rings before the system answers a call. When Toll Saver is active, the system answers after 2 rings if you have new messages, and after 4 rings if you have no new messages.

#### 1. **SETUP**

Press until desired feature is heard (see list at right).

#### 2. **CHANGE**

Press until desired selection is heard.

#### 3. **SETUP**

Press to set selection and move to next menu option.

Or

#### **(PLAY/STOP)**

Press to set selection and exit **SETUP**.

**NOTE:** Press and hold **CHANGE** to advance the remote access code number by 10.

#### Disabling the message alert function temporarily

When the answering system is turned on (the **ANSWER ON/OFF** light is lit) and the message alert function is activated, any new incoming message will increase the flashing number in the message window by one, and a beep tone will sound every ten seconds as a reminder that there are unreviewed messages on the answering system.

To temporarily disable the message alert tone, press any key (except **ANSWER ON/OFF** and **HANDSET LOCATOR** keys) on the base. This turns off the audio message alert tone but the number in the message window will continue to flash as a reminder that there are unreviewed messages on the answering system. The message alert tone will be re-activated with the next incoming message.

To switch off the message alert tone for all incoming messages, read the section on disabling the message alert function on this page above.

Number of messages (or, during playback, message number currently playing).



Press **PLAY/STOP** to begin or end message playback.



Message playback begins. See options at right.



Message playback ends.

**i** **NOTE:** If "F" is flashing in the message window, memory is full. You will have to delete some messages before new ones can be recorded.

**i** **NOTE:** New (unheard) messages cannot be deleted.

## Answering System Operation

### Message playback

Press **PLAY/STOP** to hear messages. The system announces the number of messages, then begins playback.

If you have new messages, you will hear only the new messages (oldest first). If there are no new messages, the system will play back all messages (oldest first).

### Announcements

- When playback begins, you will hear the total number of messages.
- Before each message, you will hear the day and time it was received.
- After the last message, you will hear **"End of messages"**. If the system has less than 5 minutes of recording time left, you will hear time remaining.

### Options during playback

- Press **VOLUME** button to adjust speaker volume.
- Press **SKIP** to skip to next message (or hold down to speed up message playback).
- Press **REPEAT** to repeat message currently playing. Press twice to hear previous message (or hold down to slow message playback).
- Press **DELETE** to delete message being played back.
- Press **PLAY/STOP** to stop playback.

### To delete all messages

To delete all messages, press and hold **DELETE** while the phone is idle (not during a call, or during message playback).

## Answering System Operation

### Recording and playing memos

Memos are messages you record yourself. They are saved, played back and deleted exactly like incoming messages. You can record a memo as a reminder to yourself, or leave a message for someone else if others in your household use the answering system.

#### To record a memo

Press **REC/MEMO**. Elapsed time (in seconds) is shown in the message window as you record. You can record a memo up to 4 minutes long. Memos less than 1 second long will not be recorded.

Press **PLAY/STOP** to stop recording.

#### To play back a memo

Press **PLAY/STOP** to hear messages and memos (see page 33 for other options).



Elapsed recording time (in seconds). Press **PLAY/STOP** to stop recording.

#### 1. **REC/MEMO**

 "Record after the tone. Press **STOP** when you are done."

#### 2. Speak into microphone.



#### 3. **(PLAY/STOP)**

 Beep (Memo has been recorded).



Message window

## Answering System Operation

### Message window displays

The message counter usually displays the total number of memos and incoming messages. See the list below for explanations of other displays in this counter.

#### Message counter displays

$\square$	No messages.
1-98	Number of messages/memos, or message number currently playing (flashes if you have new messages).
10-99	Current remote access code while setting (see page 32).
1-8	Current volume level while adjusting.
1-99 (counting)	Elapsed time while recording a memo (see page 34) or announcement up to 90 seconds (page 30).
99 (flashing)	Memo recording exceeded 99 seconds.
F (flashing)	Memory is full. Messages must be deleted before new messages can be received.
CL (flashing)	Clock needs to be set (see page 29).
A	Announcement Only mode is on (see page 31).
--	System is answering a call, or being accessed remotely.
-- (flashing)	System is being programmed or initialized.
On (or) OF	Displayed for one second when any feature option setting is turned on or off.
02, 04, 06, 85	Current number of rings while setting (see page 32).

1. Dial your telephone number from any touch-tone phone.
2. When system answers, enter your two-digit remote access code (19 unless you have changed it).
3. Enter remote commands (see list at right).
4. Hang up to end call and save all undeleted messages.

**i NOTE:** If you pause for more than 10 seconds during remote access, you will hear a help menu listing all features & commands. If you issue no command for another 20 seconds, the call will end automatically.

## Answering System Operation

### Remote access

Use the remote access feature to check your messages while you are away by calling your home phone number from any touch tone phone outside of your home. When the answering system picks up, simply enter a two digit security code to then access your messages. This code is set at 19 by default; see page 32 to change it.

<b>Play all messages</b> 1	Press to listen to all messages.
<b>Play new messages</b> 2	Press to listen to new messages.
<b>Delete the message</b> 3 3 3	Press during playback to delete current message. Press 3 twice to delete all old messages while it is in remote access idle mode (message not playing back).
<b>Repeat or go back</b> 4	Press during the caller's message to repeat the message. Press during the beginning of the day and time announcement to go back to the previous message.
<b>Stop</b> 5	Press to stop any operation (stop playback, stop recording).
<b>Skip to next message</b> 6	Press to skip current message and advance to next message.
<b>Review announcement</b> # 7	Press to review current outgoing announcement.
<b>Record announcement</b> * 7 to begin recording 5 to stop recording	Press * 7, wait for beep, then begin speaking. Press 5 to stop recording and listen to playback of new announcement.
<b>Record memo</b> 8 to begin recording 5 to stop recording	Press 8, wait for beep, then begin speaking. Press 5 to stop recording.
<b>Review remote access code</b> # 9	Press # 9 to review remote access code.
<b>Change remote access code</b> * 9	Press * 9 to change remote access code, then enter desired remote access code from 10-99.
<b>Help menu</b> * 5	Press to hear list of features & commands.
<b>Turn system off</b> 0	Press to turn off answering system. Incoming calls will no longer be answered.
<b>Turn system on</b> 0	If off, system will answer after 10 rings. Enter your access code, then press 0 to turn on.



## Display screen messages, lights and tones







### Screen display messages

<i>CONNECTING...</i>	The cordless handset is waiting for a dial tone.
** <i>RINGING</i> **	There is a call coming in.
** <i>PAGING</i> **	The cordless handset locator has been activated (All cordless handsets beep to help you locate them).
<i>NEEDS RECHARGING</i>	Cordless handset battery is depleted. Place cordless handset in base or charger to charge the battery.
<i>BATTERY LOW</i>	Cordless handset battery is low. Place cordless handset in base or charger to charge the battery.
<i>PHONE ON</i>	The cordless handset is in use.
<i>SPEAKER</i>	The speakerphone is in use.
<i>SCANNING...</i>	Cordless handset is scanning for a clear channel to improve sound quality.
<i>OTHER HANDSET ON</i> and then <i>OR OUT OF RANGE</i>	Another cordless handset is on a call. Or cordless handset cannot communicate with base. Check base power, or move closer.
<i>XX MISSED CALLS</i>	There are missed and un-reviewed calls in your call log.
<i>MUTE</i>	The cordless handset microphone is muted.

## Display screen messages, lights and tones



### Alert tones

	"Beep-Beep...Beep-Beep..." (Double beep every 5 seconds)	Cordless handset battery is low. Place cordless handset in base to charge the battery.
	"Beep-Beep-Beep-Beep-Beep" (5 quick beeps)	Error tone (current operation has been unsuccessful; try again).
	"Beeeeeeeeep" (1 long beep)	Confirmation tone (current operation has been successfully completed).
	"Beeeeeeeeep" (One beep every 10 seconds)	Message Alert at the telephone base (you have new message).

### Indicator lights

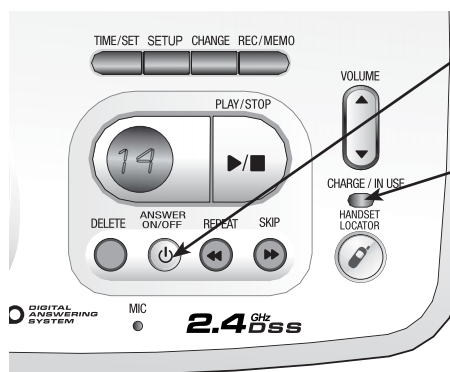

#### ANSWER ON/OFF

On when answering system is on and ready to receive calls.

#### CHARGE/IN USE

Flashes when one of the cordless handsets is in use. On when handset is positioned so its battery can charge. Flashes during an incoming call's ringing.

#### SPEAKER

On when speakerphone is in use.



#### CHARGE

On when handset is positioned so its battery can charge.



## Troubleshooting

If you have difficulty with your phone, please try the suggestions below. For Customer Service, visit our web site at [www.telephones.att.com](http://www.telephones.att.com), or call 1-800-222-3111. In Canada, call 1-866-288-4268.

**My phone doesn't work at all.**

- Make sure the power cord is securely plugged in.
- Make sure that the battery wire is securely plugged into the cordless handset.
- Make sure the telephone line cord is securely plugged firmly into the telephone base and the telephone wall jack.
- Charge the battery pack in the cordless handset for at least 16 hours. For optimum daily performance, return the cordless handset to its base when not in use.
- Reset the base. Unplug the unit's electrical power. Wait for approximately 15 seconds, then plug it back in. Allow up to one minute for the cordless handset and base to reset.
- If your batteries are old, you may need to purchase a new battery pack, please refer to page 7 of this user's manual.

---

**I cannot get a dial tone.**

- First try all the suggestions above.
- Move the cordless handset closer to the base. You might have moved out of range.
- Your line cord might be malfunctioning. Try installing a new line cord.
- If the previous suggestions don't work, disconnect the base unit from the telephone jack and connect a different phone. If there is no dial tone on that phone either, the problem is in your wiring or local service. Contact your local telephone company.

---

**I cannot dial out.**

- First try all the suggestions above.
- Make sure you have a dial tone before dialing. The cordless handset may take a second or two to find the base and produce a dial tone. This is normal. Wait an extra second before dialing.
- Make sure your phone is set to the correct dial mode for the type of service that you have (pulse or touch tone). Refer to the Installation section of this user's manual (page 11) to set the dial mode.
- If the other phones in your home are having the same problem, the problem is in your wiring or local service. Contact your local telephone company (charges may apply).
- Eliminate any background noise. Noise from a television, radio or other appliance may cause the phone to not dial out properly. If you cannot eliminate the background noise, first try muting the cordless handset before dialing, or dialing from another room in your home with less background noise.

## Troubleshooting

### **My cordless handset beeps five times and isn't performing normally.**

- Make sure the power cord is securely plugged into the base. Plug the unit into a different, working electrical outlet not controlled by a wall switch.
- Move the cordless handset closer to the base. You might have moved out of range.
- Reset the base. Unplug the unit's electrical power. Wait for 15 seconds then plug it back in. Allow up to one minute for the cordless handset and base to reset.
- Other electronic products can cause interference to your cordless phone. Try installing your phone as far away from these types of electronic devices as possible: wireless routers, radios, radio towers, pager towers, cell phones, intercoms, room monitors, televisions, personal computers, kitchen appliances and other cordless phones.

### **OTHER HANDSET ON (and then) OR OUT OF RANGE displays on my cordless handset.**

- Only one handset can be used to make or answer a call anytime. If another handset attempt to do so, the screen will display OTHER HANDSET ON and then OR OUT OF RANGE. You might press **PHONE** or **SPEAKER** again until no other handset is using the line. Use the call transfer feature (see page 15) to transfer a call to another system handset or use the speakerphone feature so multiple members of your house can be on an active call at the same time.
- Move the cordless handset closer to the base. You might have moved out of range.
- Ensure that the base is powered up.
- Place the cordless handset in base cradle for 1 minute to allow the cordless handset and base to resynchronize channels.
- If the cordless handset is in its base and the charging light does not come on, refer to the charge light is off in this troubleshooting guide.
- Reset the base. Unplug the unit's electrical power. Wait for 15 seconds then plug it back in. Allow up to one minute for the cordless handset and base to reset.
- Other electronic products can cause interference with your cordless phone. Try installing your phone as far away from these types of electronic devices as possible: wireless routers, radios, radio towers, pager towers, cell phones, intercoms, room monitors, televisions, personal computers, kitchen appliances and cordless phones.

### **The batteries will not hold a charge.**

- Charge the battery in the cordless handset for at least 16 hours. For optimum daily performance, return the cordless handset to its base when not in use.
- Ensure that the battery is properly installed and charged as described on page 7.
- Ensure that the telephone base and charger units are plugged into functioning power outlets.
- If your battery is old, you may need to purchase a new battery pack, see page 7.
- Your phone might be malfunctioning. Please refer to the Warranty section of this user's manual for further instruction.
- If the cordless handset is in its base and the charging light does not come on, refer to "The charge light is off" in this troubleshooting guide.

## Troubleshooting

### **I get noise, static, or weak signal even when I'm near the base.**

- Other cordless phones and 802.11 wireless routers that are used for home computer networks both use internal radios to communicate. The radios may interfere with one another. You can improve the performance of your cordless phones and your router by:
  - a. Positioning your new phone as far away as possible from any other existing cordless telephone system that is already installed in your home to avoid the two systems interfering with each other.
  - b. Positioning your telephone base as far as possible from your router, computer or any other computer devices.
  - c. Selecting channels 4 through 10 for your router (refer to your router's user manual for more information).
  - d. If you still have problems with the phone or the router, make sure the handset is ON and press **CHAN** until the performance improves.
- Press the **CHAN** button while on a call until the interference has been eliminated.
- Other electronic products can cause interference to your cordless phone. Try installing your phone as far away from the following electronic devices as possible: wireless routers, radios, radio towers, pager towers, cell phones, intercoms, room monitors, televisions, personal computers, kitchen appliances and other cordless phones.
- Microwaves operate on the same frequency as your phone. It is normal to experience static on your phone while the microwave oven is operating. Do not install this phone in the same outlet or near a microwave oven.
- If your phone is plugged in with a modem or a surge protector, plug the phone (or modem/surge protector) into a different location. If this solves the problem, re-locate your phone or modem farther apart from one another, or use a different surge protector.
- Relocate your phone to a higher location. The phone will likely have better reception when not installed in a low area.
- If the other phones in your home are having the same problem, the problem is in your wiring or local service. Contact your local telephone company (charges may apply).
- If you subscribe to DSL service and if you hear noise during conversations and/or your caller ID features are not functioning properly, install a noise filter to the telephone line between the base unit and the telephone line jack. Contact your DSL provider to obtain a noise filter.

### **I hear other calls while using my phone.**

- Press the **CHAN** key while on a call to change to a clear channel.
- Disconnect the base unit from the telephone jack, and plug in a different telephone. If you still hear other calls, the problem is probably in your wiring or local service. Call your local telephone company.

## Troubleshooting

**I hear noise in the cordless handset, and none of the keys or buttons work.**

- Make sure the power cord is plugged in securely.

**My cordless handset does not ring when I receive a call.**

- Make sure that the ringer is not turned off. Refer to the section(s) on ringer selection in this user's manual.
- Make sure the telephone line cord is plugged securely into the base unit and the telephone jack. Make sure the power cord is securely plugged in.
- The cordless handset may be too far from the base unit.
- Charge the battery in the cordless handset for at least 16 hours the first time. For optimum daily performance, return the cordless handset to its base when not in use. If your battery becomes completely depleted, make sure to charge it for at least 15 minutes before attempting to place a call.
- You may have too many extension phones on your telephone line to allow all of them to ring simultaneously. Try unplugging some of the other phones.
- The layout of your home or office might be limiting the operating range. Try moving the base to another location, preferably on an upper floor.
- If the other phones in your home are having the same problem, the problem is in your wiring or local service. Contact your local telephone company (charges may apply).
- Test a working phone at the phone jack. If another phone has the same problem, the problem is the phone jack. Contact your local telephone company (charges may apply).
- Other electronic products can cause interference with your cordless phone. Try installing your phone as far away as possible from electronic devices wireless routers, radios, radio towers, pager towers, cell phones, intercoms, room monitors, televisions, personal computers, kitchen appliances and other cordless phones.
- Your line cord might be malfunctioning. Try installing a new line cord.
- Re-install the battery pack, and place cordless handset in base cradle.
- Wait for the cordless handset to re-establish its connection with the base. To be safe, allow up to one minute for this to take place.

**My calls fade out or cut in and out while I'm using my cordless handset.**

- Press the **CHAN** button while on a call until the interference has been eliminated.
- Other electronic products can cause interference with your cordless phone. Try installing your phone as far away from the following electronic devices as possible: wireless routers, radios, radio towers, pager towers, cell phones, intercoms, room monitors, televisions, personal computers, kitchen appliances and other cordless phones
- Microwaves operate on the same frequency as your phone. It is normal to experience static on your phone while the microwave oven is operating. Do not install this phone in the same outlet or near the microwave oven.

## Troubleshooting

- If your phone is plugged in with a modem or surge protector, plug the phone (or modem/surge protector) into a different location. If this solves the problem, re-locate your phone or modem farther apart from one another, or use a different surge protector.
- Relocate your telephone base to a higher location. The phone will have better reception when not installed in a low area.
- If the other phones in your home are having the same problem, the problem is in your wiring or local service. Contact your local telephone company (charges may apply.)

---

### **The charge light is off.**

- Clean the cordless handset and base charging contacts each month using a pencil eraser or cloth.
- Make sure the power and line cords are plugged in correctly and securely.
- Unplug the unit's electrical power. Wait for 15 seconds, then plug it back in. Allow up to one minute for the cordless handset and base to reset.
- Your phone might be malfunctioning. Please refer to the Warranty section of this user's manual for further instruction.

---

### **My Caller ID isn't working.**

- Caller ID is a subscription service. You must subscribe to this service from your local telephone company for this feature to work on your phone.
- Your caller must be calling from an area that supports caller ID.
- Both you and your caller's telephone companies must use caller ID compatible equipment.

---

### **System does not receive CID or System does not display CID during Call Waiting.**

- Make sure you subscribe to Caller ID with Call Waiting features services provided by your local telephone company. Caller ID features will work only if both you and the caller are in areas offering Caller ID service, and if both telephone companies use compatible equipment.

---

### **Common cure for electronic equipment.**

If the unit does not seem to be responding normally, try putting the cordless handset in its base. If it does not seem to respond, do the following (in the order listed):

- Disconnect the power to the base.
- Disconnect the cordless handset battery, and spare battery, if applicable.
- Wait a few minutes.
- Connect power to the base.
- Re-install the battery pack, and place the cordless handset into the base.
- Wait for the cordless handset to re-establish its connection with the base. To be safe, allow up to one minute for this to take place.

## Troubleshooting

<b>Incomplete messages.</b>	<ul style="list-style-type: none"><li>• If a caller leaves a very long message, part of it may be lost when the system disconnects the call after 4 minutes.</li><li>• If the caller pauses for more than 7 seconds, the system stops recording and disconnects the call.</li><li>• If the system's memory becomes full during a message, the system stops recording and disconnects the call.</li><li>• If the the caller's voice is very soft, the system may stop recording and disconnects the call.</li></ul>
<b>Difficulty hearing messages.</b>	<ul style="list-style-type: none"><li>• Press <b>VOLUME</b>  to increase speaker volume.</li><li>• Remove any stickers that may have come on your telephone base and/or handset when you purchased it, they may be obstructing your messages when you play them.</li></ul>
<b>System does not answer after correct number of rings.</b>	<ul style="list-style-type: none"><li>• Make sure that the answering system is on (see page 28).</li><li>• If Toll Saver is activated, the number of rings changes to 2 when you have new messages waiting (see page 32).</li><li>• In some cases, the system may be affected by the ringing system used by the local telephone company.</li><li>• If the memory is full or the system is off, the system will answer after 10 rings.</li></ul>
<b>"CL" flashes in message window.</b>	<ul style="list-style-type: none"><li>• You need to reset the answering system clock (see page 29).</li></ul>
<b>System does not respond to remote commands.</b>	<ul style="list-style-type: none"><li>• Make sure to enter your remote access code correctly (see page 36).</li><li>• Make sure you are calling from a touch-tone phone. When you dial a number, you should hear tones. If you hear clicks, the phone is not a touch-tone telephone and cannot activate the answering system.</li><li>• The answering system may not detect the remote access code while your announcement is playing. Try waiting until the announcement is over before entering the code.</li><li>• There may be noise or interference on the phone line you are using. Press dial-pad buttons firmly.</li></ul>
<b>System does not record message.</b>	<ul style="list-style-type: none"><li>• Make sure answering system is on (see page 28).</li><li>• Make sure Announcement Only is off (see page 31).</li></ul>
<b>Announcement message is not clear.</b>	<ul style="list-style-type: none"><li>• When you record your announcement, make sure you speak in a normal tone of voice, about 9 inches from the base.</li><li>• Make sure there is no background noise (TV, music, etc.) while you are recording.</li></ul>



## Important Safety Instructions



This symbol is to alert you to important operating or servicing instructions that may appear in this user's manual. Always follow basic safety precautions when using this product to reduce the risk of injury, fire, or electric shock.

### Safety Information

---

- **Read and understand all instructions in the user's manual. Observe all markings on the product.**
- **Avoid using a telephone during a thunderstorm.** There may be a slight chance of electric shock from lightning.
- **Do not use a telephone in the vicinity of a gas leak.**  
If you suspect a gas leak, report it immediately, but use a telephone away from the area where gas is leaking. If this product is a cordless model, make sure the base is also away from the area.
- **Do not use this product near water, or when you are wet.** For example, do not use it in a wet basement or shower, or next to a swimming pool, bathtub, kitchen sink, or laundry tub. Do not use liquids or aerosol sprays for cleaning. If the product comes in contact with any liquids, unplug any line or power cord immediately. Do not plug the product back in until it has dried thoroughly.
- **Install this product in a protected location** where no one can trip over any line or power cords. Protect cords from damage or abrasion.
- **If this product does not operate normally, read "Troubleshooting" in the user's manual.** If you cannot solve the problem, or if the product is damaged, refer to the Limited Warranty. Do not open this product except as may be directed in your user's manual. Opening the product or reassembling it incorrectly may expose you to hazardous voltages or other risks.
- **If this product has user-replaceable batteries, replace batteries only as described in your user's manual.** Do not burn or puncture batteries — they contain caustic chemicals.
- **If this product has a three-prong (grounding) plug or a polarized plug with one wide prong, it may not fit in non-polarized outlets.** Do not defeat the purpose of these plugs. If they do not fit in your outlet, the outlet should be replaced by an electrician.



**CAUTION:** Use only the power adapter provided with this product. To obtain a replacement, call 1-800-222-3111. In Canada, call 1-866-288-4268.

## Important Safety Instructions

### Especially About Cordless Telephones

- **Privacy:** The same features that make a cordless phone convenient create some limitations. Telephone calls are transmitted between the base and the cordless handset by radio waves, so there is a possibility that your cordless phone conversations could be intercepted by radio receiving equipment within range of the cordless handset. **For this reason, you should not think of cordless phone conversations as being as private as those on corded phones.**
- **Electrical Power:** The base unit of this cordless telephone must be connected to a working electrical outlet. The electrical outlet should not be controlled by a wall switch. **Calls cannot be made from the cordless handset if the base unit is unplugged or switched off, or if the electrical power is interrupted.**
- **Potential TV Interference:** Some cordless telephones operate at frequencies that may cause interference to TVs and VCRs. To minimize or prevent such interference, do not place the base unit of the cordless telephone near or on top of a TV or VCR. If interference is experienced, moving the cordless telephone farther away from the TV or VCR will often reduce or eliminate the interference.
- **Rechargeable Batteries:** This product contains either Nickel-Cadmium or Nickel-Metal Hydride rechargeable batteries. Exercise care in handling batteries in order not to short the battery with conducting material such as rings, bracelets, and keys. The battery or conductor may overheat and cause harm. Observe proper polarity between the battery and the battery charger.
- **Nickel-Cadmium Rechargeable Batteries:** Must be recycled or disposed of properly. Do not dispose of them in household garbage. Do not burn or puncture. Like other batteries of this type, if burned or punctured, they could release caustic material which could cause injury.



The RBRC™ Seal means that the manufacturer is voluntarily participating in an industry program to collect and recycle Nickel-Cadmium rechargeable batteries when taken out of service within the United States. These batteries may be taken to a participating local retailer of replacement batteries or recycling center. Or you may call 1-800-8 BATTERY for locations accepting spent Nickel-Cadmium Batteries. Nickel-Metal Hydride Rechargeable Batteries: Dispose of these batteries in a safe manner. Do not burn or puncture. Like other batteries of this type, if burned or punctured, they could release caustic material which could cause injury.

- **Nickel-Metal Hydride Rechargeable Batteries:** Dispose of these batteries in a safe manner. Do not burn or puncture. Like other batteries of this type, if burned or punctured, they could release caustic material which could cause injury.

## Important Safety Instructions

### Precautions for Users of Implanted Cardiac Pacemakers

---

Cardiac Pacemakers (applies only to 900 MHz Digital Cordless Telephones):

Wireless Technology Research, LLC (WTR), an independent research entity, led a multidisciplinary evaluation of the interference between portable wireless telephones and implanted cardiac pacemakers. Supported by the U.S. Food and Drug Administration, WTR had recommended to physicians that:

#### **PACEMAKER PATIENTS**

- Should keep wireless phones at least six inches from the pacemaker.
- Should NOT place wireless phones directly over the pacemaker, such as in a breast pocket, when it is turned ON.
- Should use the wireless phone at the ear opposite the pacemaker.

WTR's evaluation did not identify any risk to bystanders with pacemakers from other persons using wireless phones.

### Especially About Telephones Answering Systems

---

Two-Way Recording: This unit does not sound warning beeps to let the other party know that the call is being recorded. To ensure that you are in compliance with any federal or state regulations regarding recording a telephone call, you should start the recording process and then inform the other party that you are recording the call.

---

## SAVE THESE INSTRUCTIONS

---

## FCC Part 68 and ACTA

This equipment complies with Part 68 of the FCC rules and with technical requirements adopted by the Administrative Council for Terminal Attachments (ACTA). The label on the back or bottom of this equipment contains, among other things, a product identifier in the format US:AAAEQ##TXXXX. This identifier must be provided to your local telephone company upon request.

The plug and jack used to connect this equipment to premises wiring and the telephone network must comply with applicable Part 68 rules and technical requirements adopted by ACTA. A compliant telephone cord and modular plug is provided with this product. It is designed to be connected to a compatible modular jack that is also compliant. An RJ11 jack should normally be used for connecting to a single line and an RJ14 jack for two lines. See Installation Instructions in the user's manual.

The Ringer Equivalence Number (REN) is used to determine how many devices you may connect to your telephone line and still have them ring when you are called. The REN for this product is encoded as the 6th and 7th characters following the US: in the product identifier (e.g., if ## is 03, the REN is 0.3). In most, but not all areas, the sum of all RENs should be five (5.0) or less. For more information, please contact your local telephone company.

This equipment may not be used with Party Lines. If you have specially wired alarm dialing equipment connected to your telephone line, ensure the connection of this equipment does not disable your alarm equipment. If you have questions about what will disable alarm equipment, consult your telephone company or a qualified installer. If this equipment is malfunctioning, it must be unplugged from the modular jack until the problem has been corrected. Repairs to this telephone equipment can only be made by the manufacturer or its authorized agents. For repair procedures, follow the instructions outlined under the Limited Warranty.

If this equipment is causing harm to the telephone network, the telephone company may temporarily discontinue your telephone service. The telephone company is required to notify you before interrupting service. If advance notice is not practical, you will be notified as soon as possible. You will be given the opportunity to correct the problem and the telephone company is required to inform you of your right to file a complaint with the FCC. Your telephone company may make changes in its facilities, equipment, operation, or procedures that could affect the proper functioning of this product. The telephone company is required to notify you if such changes are planned. If this product is equipped with a corded or cordless handset, it is hearing-aid compatible.

If this product has memory dialing locations, you may choose to store emergency telephone numbers (e.g., police, fire, medical) in these locations. If you do store or test emergency numbers, please:

- Remain on the line and briefly explain the reason for the call before hanging up.
- Perform such activities in off-peak hours, such as early morning or late evening.

## Appendix

### FCC Part 15

This equipment has been tested and found to comply with the requirements for a Class B digital device under Part 15 of the Federal Communications Commission (FCC) rules. These requirements are intended to provide reasonable protection against harmful interference in a residential installation. This equipment generates, uses and can radiate radio frequency energy and, if not installed and used in accordance with the instructions, may cause harmful interference to radio communications. However, there is no guarantee that interference will not occur in a particular installation. If this equipment does cause harmful interference to radio or television reception, which can be determined by turning the equipment off and on, the user is encouraged to try to correct the interference by one or more of the following measures:

- Increase the separation between the equipment and receiver.
- Connect the equipment into an outlet on a circuit different from that to which the receiver is connected.
- Consult the dealer or an experienced radio/TV technician for help.

Changes or modifications to this equipment not expressly approved by the party responsible for compliance could void the user's authority to operate the equipment. To ensure safety of users, the FCC has established criteria for the amount of radio frequency energy that can be safely absorbed by a user or bystander according to the intended usage of the product. This product has been tested and found to comply with the FCC criteria. The cordless handset may be safely held against the ear of the user. The base unit shall be installed and used such that parts of the user's body other than the hands are maintained at a distance of approximately 20 cm (8 inches) or more. If you choose to use a clipping device, please make sure to only use the supplied AT&T belt clip.

## Limited Warranty

The AT&T brands are used under license. Any repair, replacement or warranty service, and all questions about this product should be directed to: Advanced American Telephones, 1-800-222-3111 or [www.telephones.att.com](http://www.telephones.att.com). In Canada, call 1-866-288-4268.

1. What does this limited warranty cover?

The manufacturer of this AT&T-branded product, Advanced American Telephones (“AAT”), warrants to the holder of a valid proof of purchase (“CONSUMER” or “YOU”) that the product and all accessories provided by AAT in the sales package (“PRODUCT”) are free from material defects in material and workmanship, pursuant to the following terms and conditions, when installed and used normally and in accordance with operation instructions. This limited warranty extends only to the Consumer for Products purchased and used in the United States of America.

2. What will AAT do if the Product is not free from material defects in materials and workmanship during the limited warranty period (“MATERIALLY DEFECTIVE PRODUCT”)?

During the limited warranty period, AAT’s authorized service representative will repair or replace, at AAT’s option, without charge, a Materially Defective Product. If AAT repairs this product, AAT may use new or refurbished replacement parts. If AAT chooses to replace this product, AAT may replace it with a new or refurbished product of the same or similar design. AAT will return repaired or replacement products to you in working condition.

AAT will retain defective parts, modules, or equipment. Repair or replacement of Product, at AAT’s option, is your exclusive remedy. You should expect the repair or replacement to take approximately 30 days.

3. How long is the limited warranty period?

The limited warranty period for the Product extends for ONE (1) YEAR from the date of purchase.

If AAT repairs or replaces a Materially Defective Product under the terms of this limited warranty, this limited warranty also applies to repaired or replacement Products for a period of either (a) 90 days from the date the repaired or replacement Product is shipped to you or (b) the time remaining on the original one-year limited warranty, whichever is longer.

## Limited Warranty

### 4. What is not covered by this limited warranty?

This limited warranty does not cover:

- Product that has been subjected to misuse, accident, shipping or other physical damage, improper installation, abnormal operation or handling, neglect, inundation, fire, water, or other liquid intrusion; or
- Product that has been damaged due to repair, alteration, or modification by anyone other than an authorized service representative of AAT; or
- Product to the extent that the problem experienced is caused by signal conditions, network reliability or cable or antenna systems; or
- Product to the extent that the problem is caused by use with non-AAT accessories; or
- Product whose warranty/quality stickers, product serial number plates or electronic serial numbers have been removed, altered or rendered illegible; or
- Product purchased, used, serviced, or shipped for repair from outside the United States, or used for commercial or institutional purposes (including but not limited to Products used for rental purposes); or
- Product returned without valid proof of purchase (see 6 below); or
- charges for installation or setup, adjustment of customer controls, and installation or repair of systems outside the unit.

### 5. How do you get warranty service?

To obtain warranty service in the United States of America, call 1-800-222-3111 (In Canada, please dial 1-866-288-4268) for instructions regarding where to return the Product. Before calling for service, please check the user's manual. A check of the Product Controls and Features may save you a service call.

Except as provided by applicable law, you assume the risk of loss or damage during transit and transportation and are responsible for delivery or handling charges incurred in the transport of Product(s) to the service location. AAT will return repaired or replaced Product under this limited warranty to you, with transportation, delivery or handling charges prepaid. AAT assumes no risk for damage or loss of the Product in transit.

If the Product failure is not covered by this limited warranty, or proof of purchase does not meet the terms of this limited warranty, AAT will notify you and will request that you authorize the cost of repair prior to any further repair activity. You must pay for the cost of repair and return shipping costs for the repair of Products that are not covered by this limited warranty.

## Limited Warranty

6. What must you return with the Product to get warranty service?

You must:

- a return the entire original package and contents including the Product to the AAT service location along with a description of the malfunction or difficulty;
- b include “valid proof of purchase” (sales receipt) identifying the Product purchased (Product model) and the date of purchase or receipt (keep a copy for your records); and
- c provide your name, complete and correct mailing address, and telephone number.

7. Other limitations

This warranty is the complete and exclusive agreement between you and AAT. It supersedes all other written or oral communications related to this Product. AAT provides no other warranties for this product. The warranty exclusively describes all of AAT’s responsibilities regarding the product. There are no other express warranties. No one is authorized to make modifications to this limited warranty and you should not rely on any such modification.

**State Law Rights:** This warranty gives you specific legal rights, and you may also have other rights which vary from state to state.

**Limitations:**

Implied warranties, including those of fitness for a particular purpose and merchantability (an unwritten warranty that the product is fit for ordinary use) are limited to one year from date of purchase.

Some states do not allow limitations on how long an implied warranty lasts, so the above limitation may not apply to you.

In no event shall AAT be liable for any indirect, special, incidental, consequential, or similar damages (including, but not limited to lost profits or revenue, inability to use the product, or other associated equipment, the cost of substitute equipment, and claims by third parties) resulting from the use of this product.

Some states do not allow the exclusion or limitation of incidental or consequential damages, so the above limitation or exclusion may not apply to you.

**Please retain your receipt as your proof of purchase.**



*Appendix*

## Technical specifications

RF Frequency Band (Cordless handset to base)	921.4 MHz – 927.2 MHz
RF Frequency Band (Base to cordless handset)	2400.9 MHz – 2405.1 MHz
Operating Temperature	32°F – 122°F 0°C – 50°C
Base Unit Voltage (AC Voltage, 60Hz)	120V AC 60Hz
Base Unit Voltage (AC Adapter Output)	9V DC 400mA
Charger Voltage (AC Adapter Output)	9V DC 150mA
Cordless handset Voltage	3.6V 600mAH Ni-Cd Battery

## Index

### A

AC adapter, 6  
Alert tones, 38  
Answering calls, 12  
Answering system, 28-36

### B

Battery charging, 7  
Battery installation, 7  
Belt clip, 9

### C

Call Waiting, 14  
Call Transfer, 15  
Caller ID, 22  
    add entries to phone directory, 27  
    delete entries, 26  
    dial entries, 25

CID, 22

Clear Voice Mail Indication, 11

### D

Delete Call Log entries, 26  
Delete redial entries, 12  
Dialing,  
    from a CID record, 25  
    directory dialing, 20

Directory, 16

    dial number, 20  
    edit entries, 21  
    name search, 20  
    new entries, 18

### E

Elapsed time, 12  
Ending calls, 12

### F

Flash (switchhook flash), 14

### H

Hands-free use, 12  
Cordless handset locator, 13  
Headset, 9

### I

Incoming call log, 22  
Incoming calls, answering, 12  
Indicator lights, 38

### L

Last number redial, 12  
Low battery, 7

### M

Making calls, 12  
Menus, 10-11  
Messages, 33  
Mute, 14

### N

Names,  
    enter into directory, 18  
    search for, 20

### O

Operating range, 5

### Q

Quick reference guide, 2-3

### R

Receiving calls, 12  
Recharging, 7  
Redial, 12  
Ringer silencing, 12  
Ring tone options, 10

### S

Search for name, 20  
Speakerphone, 12  
Switchhook flash, 14

### T

Technical specifications, 53  
Troubleshooting, 39-44

### V

Volume controls, 14 & 33

## Remote access wallet card

Use the wallet card below to help you remember commands to control your answering system from any touch-tone telephone.

Cut along dotted line.



Call your phone number, then enter your 2-digit access code (preset to 19).

Action	Remote Command
Play all messages.....	1
Play new messages.....	2
Delete the message.....	3
Delete all old messages.....	3 3
Repeat or go back.....	4
Stop.....	5
Help menu.....	* 5
Skip the message.....	6
Review announcement.....	# 7
Record announcement.....	* 7
Record memo.....	8
Review remote access code..	# 9
Change remote access code..	* 9
Answer machine ON/OFF...	0

2.4 GHz Cordless Telephone/Answering System E2728B/EI 128B

Copyright © 2006 Advanced American Telephones. All Rights Reserved.  
AT&T and the Globe Design are trademarks of AT&T Corp.,  
licensed to Advanced American Telephones. Printed in China.

Fold here.



[www.telephones.att.com](http://www.telephones.att.com)

Copyright © 2006 Advanced American Telephones. All Rights Reserved.  
AT&T and the Globe Design are trademarks of AT&T Corp.,  
licensed to Advanced American Telephones. Printed in China. Issue 3 AT&T 05/06.  
91-000668-030-000