



at&t

User's manual

SL81108/SL81208

DECT 6.0 cordless

**telephone with caller ID/call
waiting**



Congratulations

on your purchase
of this AT&T product.

Before using this AT&T product, please
read the **Important safety information**
on pages 51-53 of this manual.

Please thoroughly read this user's
manual for all the feature operations
and troubleshooting information necessary
to install and operate your new
AT&T product. You can also visit our
website at **www.telephones.att.com** or call
1 (800) 222-3111.

In Canada, dial **1 (866) 288-4268.**

Model #: SL81108 (single handset)/SL81208 (two handsets)

Type: DECT 6.0 cordless telephone

Serial #: _____

Purchase date: _____

Place of purchase: _____

Both the model and serial number of your AT&T product can be found on the
bottom of the telephone base.

Save your sales receipt and original packaging in case it is necessary to return
your telephone for warranty service.



The ENERGY STAR[®] program (www.energystar.gov) recognizes and encourages the use of products that save energy and help protect our environment. We are proud to mark this product with the ENERGY STAR[®] label indicating it meets the latest energy efficiency guidelines.

Parts checklist

Your telephone contains the following items.

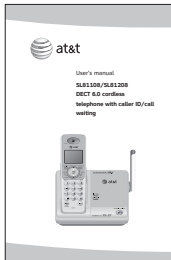

User's manual

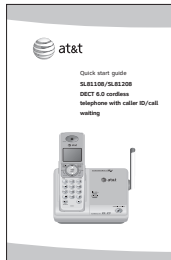

Quick start guide



Cordless handset
(1 for SL81108)
(2 for SL81208)



Telephone base with
mounting bracket,
telephone line cord and
power adapter installed



Charger for cordless handset
with power adapter installed
(1 for SL81208)



Battery for cordless handset
(1 for SL81108)
(2 for SL81208)



Battery compartment cover
(1 for SL81108)
(2 for SL81208)



Belt clip for cordless handset
(1 for SL81108)
(2 for SL81208)

User's manual

SL81108/SL81208

**DECT 6.0 cordless
telephone with caller ID/call
waiting**



Table of contents

Getting started

Quick reference guide

- handset 2
- telephone base 3

Installation preparation..... 4

Telephone base & charger

- installation..... 5

Battery installation & charging... 7

Belt clip & optional headset.....9

Mounting bracket procedure.....10

Handset settings

Handset settings.....17

Telephone operation

Handset operation22

Options while on calls.....25

Intercom.....28

Call transfer using intercom30

Directory

About the directory.....32

Creating directory entries33

Directory review35

Directory search.....36

To dial, delete or
edit entries.....37

Caller ID

Caller ID operation.....38

To review the caller ID
history41

Appendix A, Screen icons,
lights & tones.....43

Appendix B, Handset display
screen messages.....45

Appendix C, Adding and
registering handsets48

Appendix D, Replacing a
handset49

Appendix E, Maintenance.....50

Appendix F, Important safety
information.....51

Appendix G, FCC Part 68 and
ACTA.....54

Appendix H, FCC Part 15.....56

Appendix I,
Limited warranty.....57

Appendix J, Technical
specifications.....60

Appendix K,
Troubleshooting.....61

Index.....68

Quick reference guide - handset

CHARGE indicator

On when the handset is charging in the telephone base or charger.

DIR / **CID**

Press  **DIR** to display directory entries (page 35). Press to scroll up while in menus.

While entering names or numbers, press to move the cursor to the right.

Press  **CID** to display caller ID history (page 41).

Press to scroll down while in menus.

While entering names or numbers, press to move the cursor to the left.

REDIAL/PAUSE

Press to view redial memory (page 26).

While entering numbers, press and hold to insert a dialing pause (page 33).

PHONE/FLASH

Press to make or answer a call. During a call, press to receive an incoming call if call waiting is activated (page 25).

SPEAKER

Press to turn on the handset speakerphone. Press again to resume normal handset use (page 22).

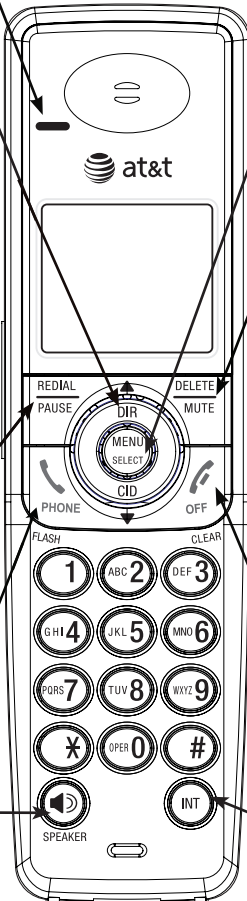

MENU/SELECT

Press to display the menu. While in the menu, press to select an item or save an entry or setting.

DELETE/MUTE

During a call, press to mute microphone (page 26). While reviewing the caller ID history, press to delete an individual entry, or press and hold to clear the caller ID history (page 42). While predialing, press to delete digits (page 22).

VOLUME

Press on the side of the handset to adjust listening volume when on a call.

Press to adjust ringer volume when in idle mode.

OFF/CLEAR

During a call, press to hang up. While using menus, press to cancel an operation, back up to the previous menu, or exit the menu display.

INT

Press to begin an intercom conversation or to transfer a call (pages 28-31).

Quick reference guide - telephone base

Feature menu

The > symbol shows a highlighted menu item.

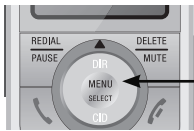
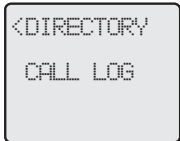

Feature menu

- DIRECTORY (page 35)
- CALL LOG (page 41)
- RINGER VOLUME (page 17)
- RINGER TONE (page 18)
- KEY TONE (page 18)
- LANGUAGE (page 19)
- CLR VOICE MAIL (page 20)

Using menus

Press  or  to scroll through menu items.

Press **MENU/SELECT** to select or save changes to a highlighted menu item.

Press  **OFF/CLEAR** to cancel an operation, back up to the previous menu, or exit the menu display.

IN USE indicator

- On when the handset is in use, when you are registering a handset.
- Flashes when another telephone is in use on the same line, or you are deregistering handset(s) from the telephone base.
- Flashes quickly when there is an incoming call.

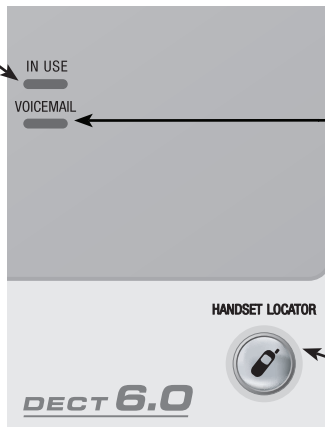

VOICEMAIL indicator

Flashes when you have new voice mail. Voice mail is provided by your local telephone company. It is different from the answering system on the telephone base.

HANDSET LOCATOR

Press to make handsets beep so you can locate them (page 24).

Installation preparation

You must install and charge the battery before using the telephone.



See page 7 for easy instructions.

If you subscribe to high-speed internet service (Digital Subscriber Line - DSL) through your telephone lines, you must have a DSL filter between the telephone base and the telephone wall jack (see the following page). The filter will prevent noise and caller ID problems caused by DSL interference. Please contact your DSL service provider for more information about DSL filters.

Your product may be shipped with a protective sticker covering the handset or telephone base display - remove it before use.

For customer service or product information, visit our website at **www.telephones.att.com** or call **1 (800) 222-3111**. In Canada, dial **1 (866) 288-4268**.

Avoid placing the telephone base too close to:

- Communication devices such as: television sets, VCRs, or other cordless telephones.
- Excessive heat sources.
- Noise sources such as a window with traffic outside, motors, microwave ovens, refrigerators, or fluorescent lighting.
- Excessive dust sources such as a workshop or garage.
- Excessive moisture.
- Extremely low temperature.
- Mechanical vibration or shock such as on top of the washing machine or work bench.

Telephone base & charger installation

Install the telephone base as shown below. Make sure that the electrical outlet is not controlled by a wall switch.

If you subscribe to high-speed internet service (Digital Subscriber Line - DSL) through your telephone lines, you must have a DSL filter between the telephone base and the telephone wall jack. The filter will prevent noise and caller ID problems caused by DSL interference. Please contact your DSL service provider for more information about DSL filters.

The telephone base comes with the mounting bracket installed for desktop use. Also, the telephone line cord and the power adapter are already plugged into the telephone base. If you want to change to wall mounting installation, see page 10 for details.

Telephone base installation

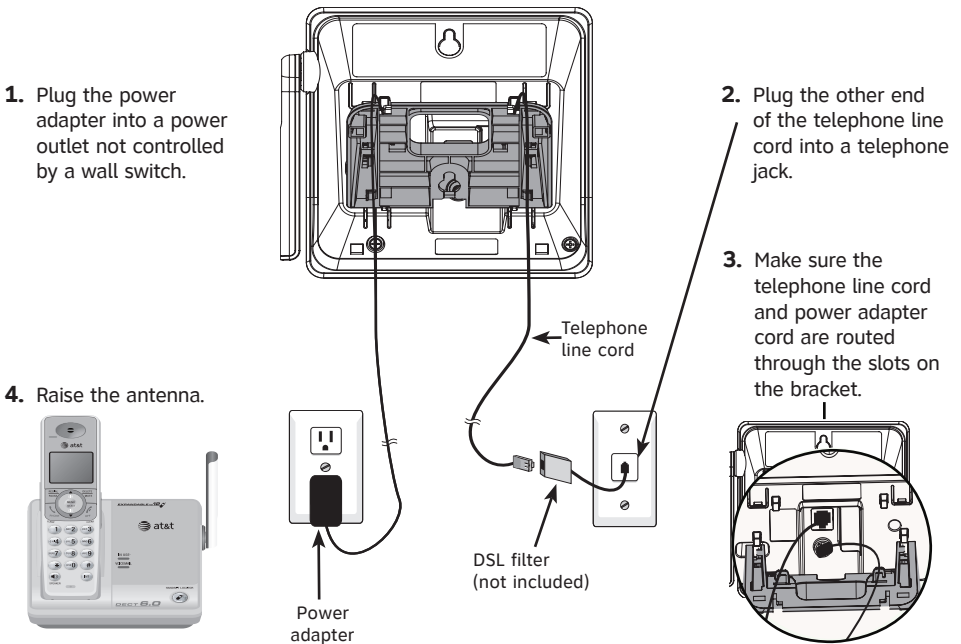

Telephone base & charger installation

Charger installation

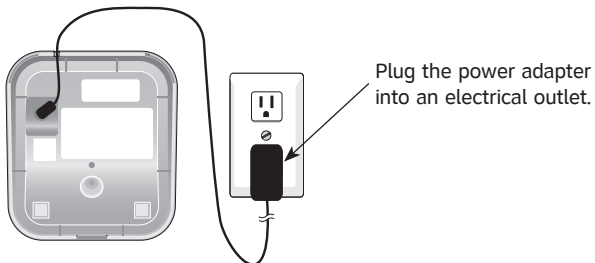

IMPORTANT INFORMATION

1. Use only the power adapter(s) supplied with this product. To order a replacement power adapter, visit our website at www.telephones.att.com, or call **1 (800) 222-3111**. In Canada, dial **1 (866) 288-4268**.
2. The power adapters are intended to be correctly oriented in a vertical or floor mount position. The prongs are not designed to hold the plug in place if it is plugged into a ceiling, under-the-table or cabinet outlet.

Battery installation & charging

Install the battery as shown below. After installing the battery, you can make and receive short calls, but replace the handset in the telephone base or charger when not in use. For optimal performance, charge the handset battery for at least 16 hours before use. When fully charged, the handset battery provides approximately five hours of talk time or three days of standby time.



Step 1

Plug the battery securely into the connector inside the handset battery compartment, matching the color-coded label.



Step 2

Insert the supplied battery with the label **THIS SIDE UP** facing up as indicated.



Step 3

Align the cover flat against the battery compartment cover, then slide it upwards until it clicks into place.

Battery installation & charging

Step 4

Charge the handset by placing it face up in the telephone base or charger. The **CHARGE** light will be on when charging.



IMPORTANT INFORMATION

Use only the supplied rechargeable battery or replacement battery (model BT8001). To order, visit our website at www.telephones.att.com or call **1 (800) 222-3111**. In Canada, dial **1 (866) 288-4268**.

Belt clip & optional headset

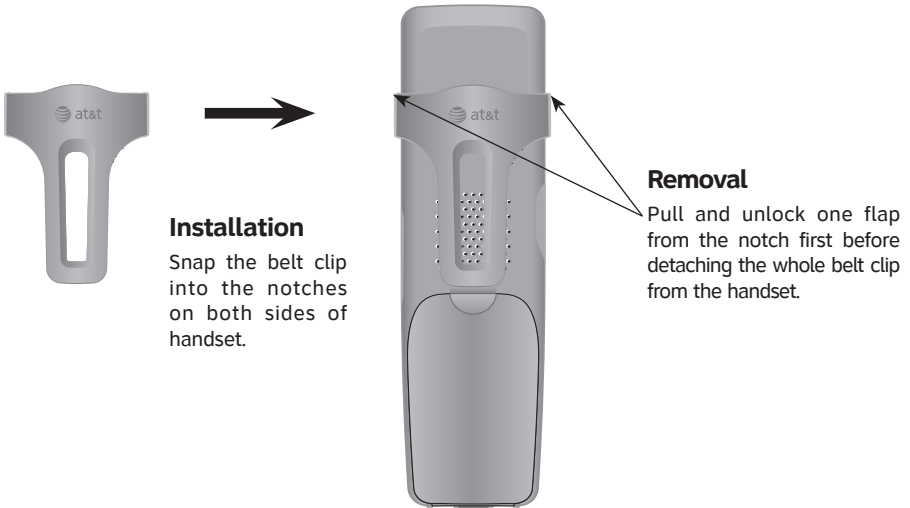

For handsfree telephone conversations, you can use any industry standard 2.5 mm headset (purchased separately). For best results, use an AT&T 2.5 mm headset. To purchase a headset, visit our website at www.telephones.att.com or call **1 (800) 222-3111**. In Canada dial **1 (866) 288-4268**.

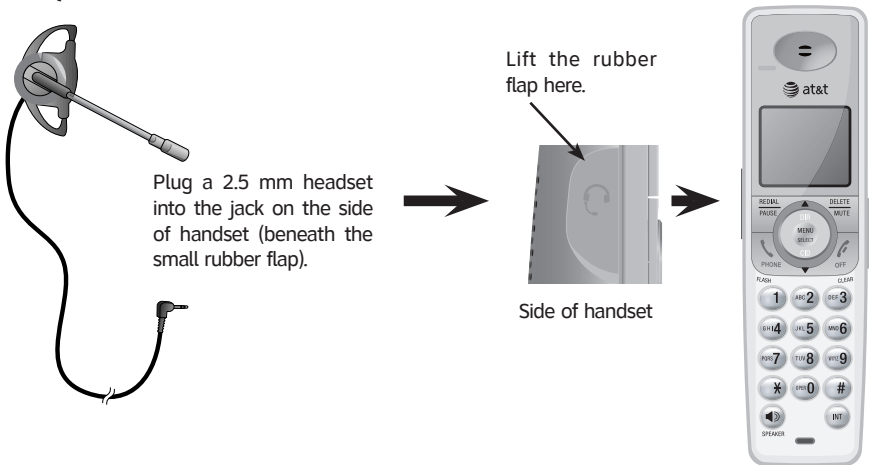

Mounting bracket procedure

The telephone base comes with the mounting bracket installed for desktop use. Wall mounting requires a telephone outlet wall mounting plate with mounting studs that may require professional installation. You can purchase the mounting plate from many hardware or consumer electronics retailers.



NOTE: The mounting bracket must be used for both tabletop and wall mounting positions.

Desktop to wall mount installation

To change the telephone base to the wall mount position:

1. Remove the cords from the routing slots on the bracket.
2. Place the telephone base on a flat surface with the antenna on the left side as shown in Figure 2.

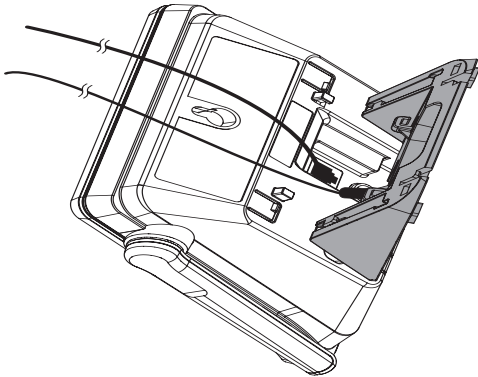

Figure 1. Cords removed from the routing slots

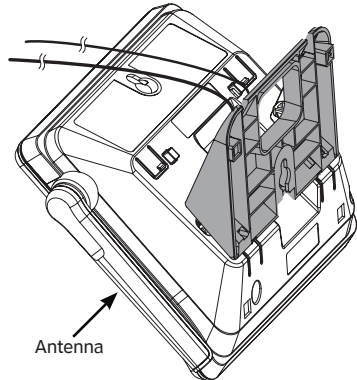

Figure 2. Desktop mounting bracket location

Mounting bracket procedure

Desktop to wall mount installation

3. Position your hands as shown in Figure 3. Press your thumbs down on the tabs that are below the bracket, holding it in place. Use your index fingers to move the bracket towards yourself.

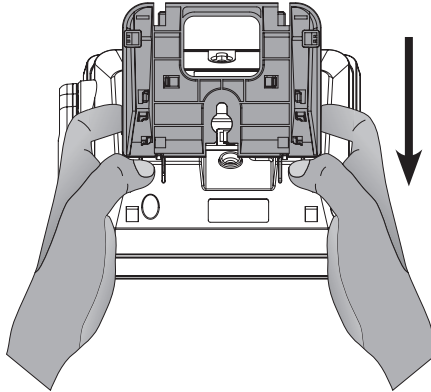

Figure 3. Detaching the bracket from the telephone base

4. Tilt the top of the bracket away from you until it is resting on the telephone base.
5. Align the grooves of the bracket with the upper keeper tabs on the telephone base. Make sure the cords are pointing towards you as shown in Figure 4.

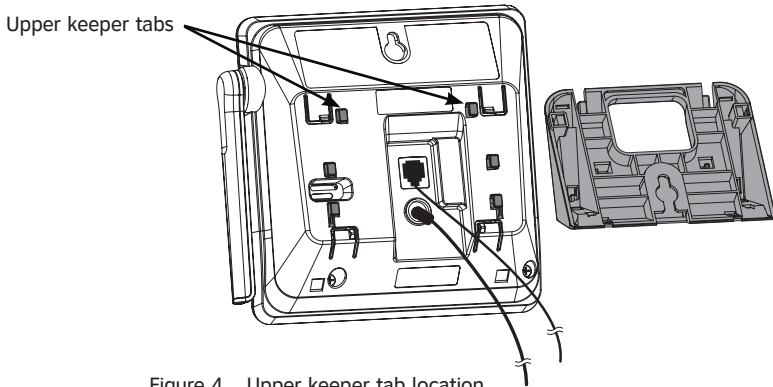

Figure 4. Upper keeper tab location

Mounting bracket procedure

Desktop to wall mount installation

6. Slide the bracket away from you until it clicks into the keeper tabs.

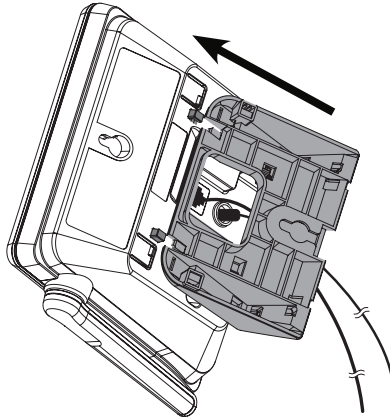

Figure 5. Upper keeper tab location

7. Align the holes on the telephone base with the standard wall plate and slide the bracket until the telephone is secured as shown in Figure 6.

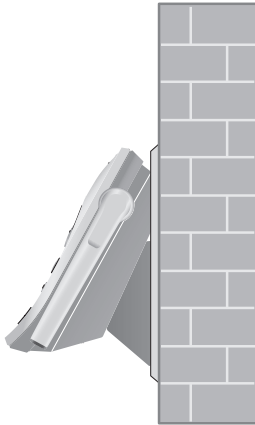
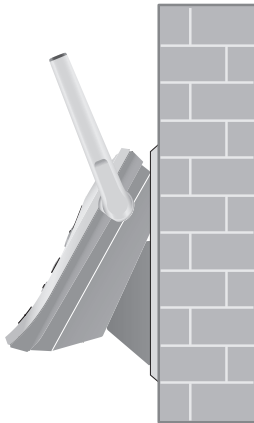

Figure 6. Wall mount position

Mounting bracket procedure

Desktop to wall mount installation

8. Raise the antenna.



Mounting bracket procedure

Wall mount to desktop installation

To change the telephone base to the desktop position:

1. Remove the telephone base from the wall.
2. Place the telephone base on a flat surface with the antenna on the left side as shown in Figure 7.

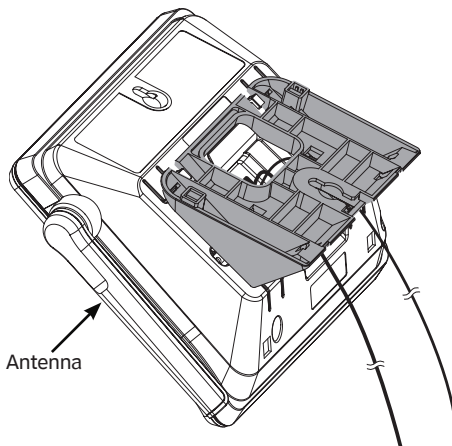

Figure 7. Wall mounting bracket location

Mounting bracket procedure

Wall mount to desktop installation

3. Maintain contact with the telephone base and slide the bracket towards you until it is free of the upper keeper tabs shown in Figure 8.

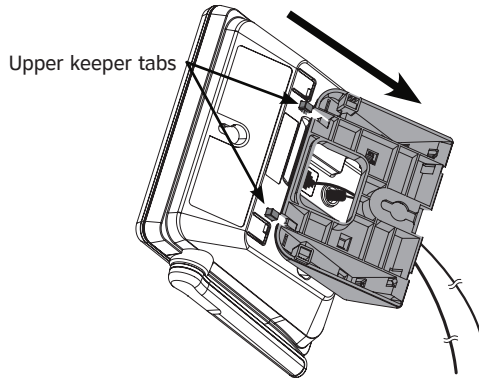

Figure 8. Upper keeper tab location

4. Tilt the top of the bracket towards you until it is resting on the telephone base.
5. Align the grooves of the bracket with the lower keeper tabs on the base. Make sure the cords are pointing away from you as shown in Figure 9.

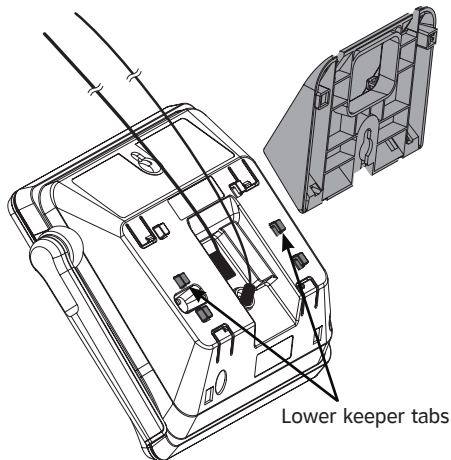

Figure 9. Lower keeper tab location

Mounting bracket procedure

Wall mount to desktop installation

6. Slide the bracket away from you until it clicks into the keeper tabs.

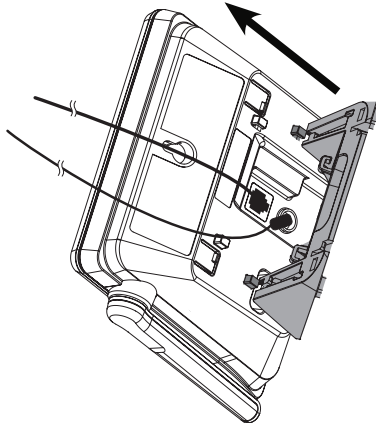
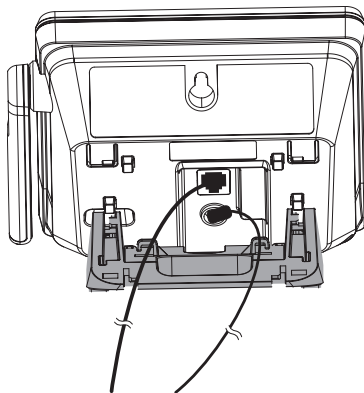



Figure 10. Lower keeper tab location

7. Route the telephone line cord and the power adapter through the slots on the bracket.





Handset settings

Using the feature menu, you can customize many of the telephone's settings.

1. Press **MENU/SELECT** when in idle mode (when the phone is not in use) to enter the feature menu.
2. Use  **DIR** /  **CID** to scroll to the feature to be changed. When scrolling through the menu, the top menu item is always highlighted with a > symbol.
3. Press **MENU/SELECT** to select the highlighted item.







NOTE: To cancel an operation, back up to the previous menu or exit the menu display, press  **OFF/CLEAR**. Press and hold  **OFF/CLEAR** to return to idle mode.

Ringer volume

Using this menu, you can set the ringer volume level (1-6), or turn the ringer off. When the ringer is turned off,  will appear on the handset screen.

To adjust the **RINGER VOLUME:**

1. Press **MENU/SELECT** when in idle mode to enter the feature menu.
2. Use  **DIR** /  **CID** to scroll to **>RINGER VOLUME**, then press **MENU/SELECT**.
3. Press  **DIR** /  **CID** to sample each volume level.
4. Press **MENU/SELECT** to save your preference and return to the feature menu.

-OR-

When the handset is in idle mode, press the **VOLUME ▼▲** buttons on the right side of the handset to change the ringer volume.



NOTE: The ringer volume also determines the ringer volume of intercom calls (pages 28-29) and the paging tone for the handset locator feature (page 24). If the handset ringer volume is set to off, that handset is silenced for all incoming calls and paging.



```
>DIRECTORY
CALL LOG
```

```
>RINGER TONE
KEY TONE
```

```
RINGER TONE
1
```

```
>DIRECTORY
CALL LOG
```

```
>KEY TONE
LANGUAGE
```





```
KEY TONE
ON
```

Handset settings

Ringer tone

This feature allows you to choose one of 10 ringer tones.





To choose a ringer tone:

1. Press **MENU/SELECT** when in idle mode to enter the feature menu.
2. Use  **DIR** /  **CID** to scroll to **>RINGER TONE**, then press **MENU/SELECT**.
3. Press  **DIR** /  **CID** to get to the next ringer tone and to hear a sample of it.
4. Press **MENU/SELECT** to save your preference and return to the feature menu.

Key tone

The handset is factory programmed to beep with each key press. If you turn off the **KEY TONE**, there will be no beeps when keys are pressed.

To turn the **KEY TONE** on or off:





1. Press **MENU/SELECT** when in idle mode to enter the feature menu.
2. Use  **DIR** /  **CID** to scroll to **>KEY TONE**, then press **MENU/SELECT**.
3. Press  **DIR** /  **CID** to select **ON** or **OFF**.
4. Press **MENU/SELECT** to save your preference and return to the feature menu.

Handset settings

Language

In this menu, you can select the language used for all screen displays.

To select a language:

1. Press **MENU/SELECT** when in idle mode to enter the feature menu.
2. Use  **DIR** /  **CID** to scroll to **>LANGUAGE**, then press **MENU/SELECT**.
3. Press  **DIR** /  **CID** to select **ENGLISH**, **FRANCAIS** or **ESPANOL**.
4. Press **MENU/SELECT** to save your preference and return to the feature menu.



>DIRECTORY
CALL LOG



>LANGUAGE
CLR VOICE MAIL



LANGUAGE
ENGLISH

Handset settings

Visual message waiting (voicemail) indicator

If you subscribe to a voice mail service provided by your local telephone company, the visual message waiting indicator (VMWI) feature will provide visual indication when you have new voice a mail messages - the **VOICEMAIL** light on the telephone base will flash, and **NEW VOICE MAIL** and the  icon will appear on all handset screens.





NOTE: This feature does not indicate new answering system messages recorded on your phone.

To clear voice mail indication

Use this feature when the telephone indicates that there is new voice mail but there is none (for example, when you have accessed your voice mail from a different telephone line while away from home). If there actually are new voice mail messages, your local telephone company will continue to send the signal to activate the visual message waiting indicator.

To manually turn off the new voice mail indicator:

1. Press **MENU/SELECT** when in idle mode to enter the feature menu.
2. Use  **DIR** /  **CID** to scroll to **>CLR VOICE MAIL**, then press **MENU/SELECT**.
3. Press **MENU/SELECT** again to turn the voice mail indication off, or press  **OFF/CLEAR** to cancel the procedure.



NOTES:

1. The telephone company voice mail may alert you to new messages with stutter (broken) dial tone. Contact your telephone company for more details.
2. This only turns off the displayed **NEW VOICE MAIL** message,  icon and **VOICEMAIL** light; it does not delete your voice mail message(s).

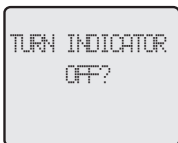
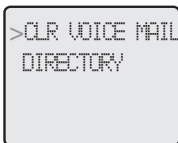
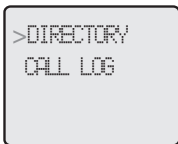



 OFF/CLEAR



DELETE/MUTE

Handset settings

Temporary ringer silencing

Press  **OFF/CLEAR** or **DELETE/MUTE** while the telephone is ringing to silence the ringer temporarily. This will silence the ringer without disconnecting the call. The next incoming call will ring normally at the preset volume.



NOTE: If more than one handset is installed, each handset will ring when there is an incoming call unless the ringer volume is turned off. Pressing  **OFF/CLEAR** or **DELETE/MUTE** on one handset will only silence the ringer of that particular handset.

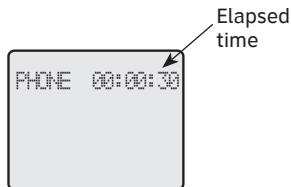

NOTE: Pressing **PHONE/FLASH** to access services from your local telephone service provider will not affect the elapsed time.

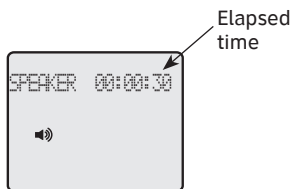

Handset operation

Making a call

To make a call:

- Press **PHONE/FLASH** or **SPEAKER**, then enter the telephone number.

To end a call:

- Press **OFF/CLEAR** or return the handset to the telephone base or charger.

The screen displays the elapsed time as you talk (in hours, minutes and seconds).

On-hook dialing (predialing)

- Enter the telephone number. Press **DELETE/MUTE** or **OFF/CLEAR** to make corrections when entering the phone number.
- Press **PHONE/FLASH** or **SPEAKER** to dial.

The screen displays the elapsed time as you talk (in hours, minutes and seconds).

Handset speakerphone

During a call, you can press **SPEAKER** to alternate between hands-free speakerphone and normal handset use. Press **OFF/CLEAR** to hang up.



NOTE: If a headset is plugged into the handset, you will not be able to use the handset speakerphone.

Answering a call

To answer a call:

- Press **PHONE/FLASH** or **SPEAKER**.
- OR–
- Press any dial pad key (0-9, * or #).

To end a call:

- Press **OFF/CLEAR** or return the handset to the telephone base or charger.



Handset operation

Auto off

A call will end automatically when you put the handset in the telephone base or charger.

**Last number redial**



To view the five most recently dialed numbers:

- Press **REDIAL/PAUSE** to display the most recently called number (up to 30 digits).
- Press  **DIR /**  **CID** or **REDIAL/PAUSE** repeatedly to view up to five recently called numbers.



The handset will beep twice at the beginning and at the end of the list.

Press  **OFF/CLEAR** to exit.

To redial a number:

- Press  **PHONE/FLASH** or  **SPEAKER** to dial the displayed number.

–OR–

- Press  **PHONE/FLASH** or  **SPEAKER**, then **REDIAL/PAUSE** to call the most recently called number (up to 30 digits).

While reviewing the redial memory, press **DELETE/MUTE** to delete the displayed number.

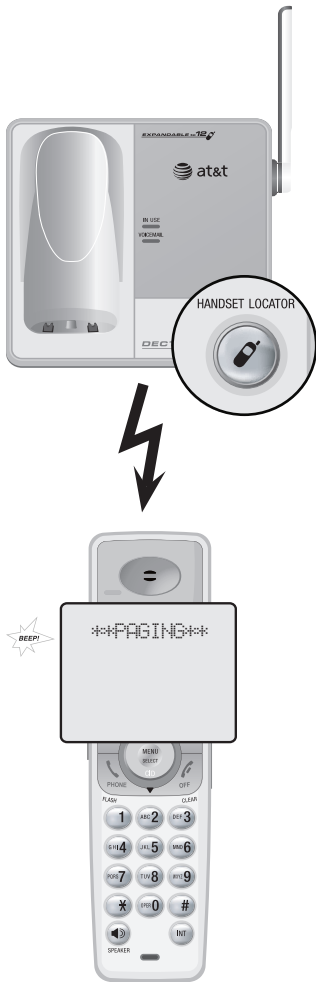

Handset operation

Handset locator

The handset locator feature is useful if you misplace a handset(s).



To start the paging tone:

- Press  **HANDSET LOCATOR** at the telephone base. This starts the paging tone on the handset(s) for 60 seconds.



NOTE: When paging, if you press  **OFF/CLEAR** or **DELETE/MUTE** on a handset, the ringer of the handset will be silent but the handset locator feature will not be cancelled.

To stop the paging tone:

- Press  **PHONE/FLASH**,  **SPEAKER**, or any dial pad key (0-9, *, or #) on the handset(s),
- OR–
- Press  **HANDSET LOCATOR** on the telephone base.



NOTE: The handset ringer volume also determines the level of the paging tone. If the handset ringer volume level is set to off, that handset will be silent for all calls and paging (page 17).

Options while on calls

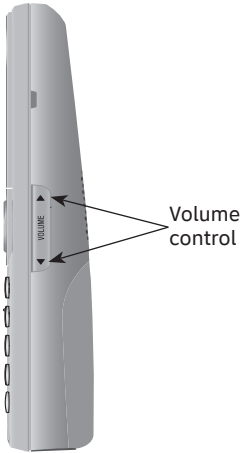

Volume control

Press the **VOLUME ▼▲** keys on the side of the handset to adjust the listening volume. Each press of the button increases or decreases the volume level.



NOTES:

1. All volume settings, (normal handset, speakerphone, and headset) are independent.
2. When the volume reaches the minimum or maximum setting, you will hear two beeps.

Call waiting

If you subscribe to call waiting service with your local telephone service provider, you will hear a beep if someone calls while you are already on a call. Press **☎PHONE/FLASH** to put your current call on hold and take the new call. You can press **☎PHONE/FLASH** at any time to switch back and forth between calls.

Multiple handset use (not for model SL81108)

If a handset is already on a call and you'd like to join the call, press **☎PHONE/FLASH** or **🔊SPEAKER** on another system handset.

Press **🔌OFF/CLEAR** or place the handset in the telephone base or charger to exit the call. The call will not be terminated until all handsets hang up.



NOTE: Only two system handsets can be used at the same time on an outside call.

Options while on calls

REDIAL/PAUSE

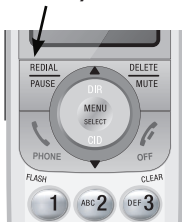

Last number redial

Press **REDIAL/PAUSE** to display and dial the most recently dialed number. If you press **REDIAL/PAUSE** again within two seconds, the number will not be dialed.



NOTE: While on a call, only the most recently called number can be reviewed, and erasing the entry is not allowed. For more details about the redial memory, see page 26.

Mute

The mute function allows you to turn off the microphone. You can hear the caller, but the caller will not be able to hear you.

To mute the call:

- Press **DELETE/MUTE** to turn off the microphone. When mute is on, the handset screen will show **MUTED** for a few seconds and the **MUTE** icon will be shown until mute is turned off.

To un-mute the call:

- Press **DELETE/MUTE** again and resume speaking. When mute is turned off, **MICROPHONE ON** will display temporarily on the handset screen.



NOTE: You cannot press **OFF/CLEAR** to exit redial, directory or caller ID history without ending the call.

Options while on calls

Directory





Press  **DIR** to review the directory. To dial the displayed number, press **MENU/SELECT**.

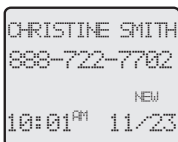

NOTE: You cannot edit a directory entry while you are on a call. For more details about the directory, see page 35.

Caller ID history



Press  **CID** to review the caller ID history. To dial the displayed number, press **MENU/SELECT**.



NOTE: You cannot copy a caller ID entry into the directory while you are on a call. For more details about the caller ID history, see page 41.

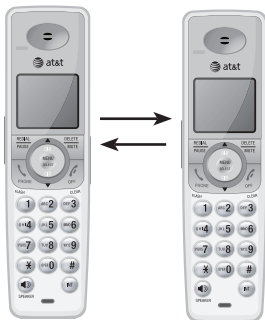

Intercom

Use the intercom feature for conversations between handsets. Unless additional handsets have been registered, this feature is not available on model SL81108.

You can buy additional accessory handsets, (SL80108), for this telephone base. Up to 12 handsets can be registered to the base. The first nine handsets that you register will be named Handsets 1-9. These names will appear in the top lines of the displays of those handsets, and you use the name of the handset for intercomming and transferring calls.

Although the names for handsets 10-12 will appear in their displays as 10-12, when you intercom or transfer to one of them, you must use *0 for Handset 10, *1 for handset 11, and *2 for Handset 12.

Model SL81208

1. Press **INT**. The screen will show **CALLING OTHER HANDSET**. The called handset will ring, and its screen will show **OTHER HANDSET IS CALLING**.
2. On the ringing handset, press **\PHONE/FLASH**, **INT**, **▶SPEAKER**, or any dial pad key (0-9, * or #) to answer the intercom call.

Intercom with three or more registered handsets (Option for accessory handset(s))

1. Press **INT**. The screen will show **INTERCOM TO:**.
2. Enter the handset number, **1-9** or ***0-2**. The display will show **CALLING HANDSET X**, with **X** being the handset number. The called handset will ring, and its screen will show **HANDSET X IS CALLING**.
3. On the ringing handset, press **\PHONE/FLASH**, **INT**, **▶SPEAKER**, or any dial pad key (0-9, * or #) to answer the intercom call.



Intercom

To end the intercom call:

- Press  **OFF/CLEAR** or **INT** on either handset.
- **-OR-**
- Place either handset in the charger or telephone base.



NOTES:

1. Before the intercom call is answered, you can cancel the intercom call by pressing  **OFF/CLEAR** or **INT** on the calling handset.
2. If the called handset is not answered within 100 seconds, or if it is in the directory or caller ID history mode, or on a call, or out of range, the calling handset will show the message **UNABLE TO CALL TRY AGAIN**.
3. Pressing  **OFF/CLEAR** or **DELETE/MUTE** will temporarily silence the intercom ringer.
4. You can buy additional accessory handsets, (SL80108). If there are a total of two handsets registered to the telephone base, the intercom feature will be the same as that of model SL81208. If there are more than two handsets registered to the telephone base, the intercom feature will be the same as that of **Intercom with three or more registered handsets**. If you want to intercom with the handset 10, 11 or 12, enter the handset number as ***0**, ***1** or ***2** respectively on the calling handset.

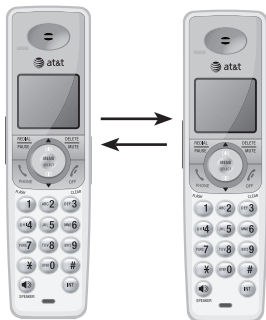

Call transfer using intercom

Use the intercom feature to transfer an outside call from one handset to another. Unless additional handsets have been registered, this feature is not available on model SL81108.

Model SL81208

1. When on an outside call, press **INT**. The outside call is automatically placed on hold. The transferring set's screen will show **CALLING OTHER HANDSET**. The called handset will ring, and its screen will show **OTHER HANDSET IS CALLING**.
2. On the ringing handset, press **PHONE/FLASH**, **INT**, **SPEAKER**, or any dial pad key (0-9, * or #) to answer the intercom call. You can now talk without the outside caller hearing the conversation.
3. Press **OFF/CLEAR** on the transferring handset or place it in the telephone base or handset charger to complete the transfer. The transferring handset's screen will show **CALL TRANSFERED** and the other handset will automatically be connected to the outside call.

NOTES:

1. Before the intercom call is answered, you can cancel the transfer and return to the outside call by pressing **OFF/CLEAR**, **PHONE/FLASH**, or **INT**.
2. If the called handset does not answer the intercom call within 100 seconds, is in directory or caller ID history mode or is out of range, the transferring handset will show **UNABLE TO CALL TRY AGAIN** on its screen and will automatically return to the outside call.
3. You can switch between the intercom call and the outside call by pressing **INT** on the transferring handset. The display will alter between **INTERCOM** and **OUTSIDE CALL** to indicate which call is active.
4. You can end the intercom call and return to the outside call by pressing **PHONE/FLASH** on the transferring handset.
5. If you register an accessory handset to your SL81108 (for a total of two handsets), call transfer using intercom will be the same as model SL81208.

Call transfer using intercom

Call transfer with three or more registered handsets (Option for accessory handset(s))**NOTES:**

1. Before the intercom call is answered, you can cancel the transfer and return to the outside call by pressing **OFF/CLEAR**, **PHONE/FLASH**, or **INT**.
 2. If the called handset does not answer the intercom call within 100 seconds, is in directory or caller ID history mode or is out of range, the transferring handset will show **UNABLE TO CALL TRY AGAIN** on its screen and will automatically return to the outside call.
 3. You can switch between the intercom call and the outside call by pressing **INT** on the transferring handset. The display will change between **INTERCOM** and **OUTSIDE CALL** to indicate which call is active.
 4. You can end the intercom call and return to the outside call by pressing **PHONE/FLASH** on the transferring handset.
 5. If you register two or more accessory handsets (for a total of three or more), the feature of call transfer using intercom will be the same as **Call transfer with three or more registered**. If you want to transfer the call to handset 10, 11 or 12, enter the handset number as ***0**, ***1** or ***2** respectively on the calling handset.
1. While on an outside call, press **INT**. The outside call is automatically placed on hold and **TRANSFER TO:** is displayed on the screen.
 2. Enter a handset number, **1-9** or ***0-*2**. The transferring set's screen will show **CALLING HANDSET X**. The called handset will ring, and its screen will show **HANDSET X IS CALLING**.
 3. On the ringing handset, press **PHONE/FLASH**, **INT**, **SPEAKER**, or any dial pad key (0-9, * or #) to answer the intercom call. You can now talk without the outside caller hearing the conversation.
 4. Press **OFF/CLEAR** on the transferring handset or place it in the telephone base or handset charger to complete the transfer. The transferring handset's screen will show **CALL TRANSFERED** and the other handset will automatically be connected to the outside call.

About the directory

Shared directory

The directory is stored in the telephone base, and is shared by all handsets. Changes made to the directory on any one handset will apply to all.

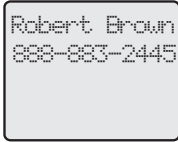

Robert Brown
888-883-2445



NOTE: Only one handset can review the directory at a time. If another handset attempts to enter the directory, the screen will display **NOT AVAILABLE AT THIS TIME**.

Capacity

The directory can store up to 50 entries, with a maximum of 15 alphanumeric characters (including spaces) for the names and 30 digits for the telephone numbers. A convenient search feature can help you find and dial numbers quickly (page 36).

If there are already 50 entries, the screen will display **LIST FULL**. You will not be able to store a new number until an existing one is deleted.

Exiting the directory



Press **OFF/CLEAR** to cancel an operation, back up to the previous menu, or exit the menu display. Press and hold **OFF/CLEAR** to return to the idle mode.

If you pause for too long while creating or reviewing an entry, the procedure will time out and you will have to begin again.



Creating directory entries

To create a new directory entry



1. Press **MENU/SELECT** when in idle mode to enter the feature menu.
2. Press **MENU/SELECT** again to enter **>DIRECTORY** menu.
3. Press  **CID** to highlight **STORE**.
4. Press **MENU/SELECT**
5. Enter the telephone number when prompted.
 - Use the dial pad to enter up to 30 digits.
 - Press  **DIR** /  **CID** to move the cursor to the right or left.
 - Press **DELETE/MUTE** to erase digits.
 - Press and hold **DELETE/MUTE** to erase all digits.
 - Press and hold **REDIAL/PAUSE** to enter a three-second dialing pause.

-OR-

- Copy a number from redial by pressing **REDIAL/PAUSE** then press  **DIR** or  **CID** to locate the number to copy. Press **MENU/SELECT** to copy the number.
6. Press **MENU/SELECT** to save the number in the display.

The display will show **ALREADY SAVED** if the number is already in the directory. The same number cannot be saved twice.

Creating directory entries

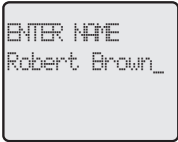

NOTE: The first letter of every word will be capitalized. The remaining letters in a word begin with lower case letters shown in the chart to the right.

7. Enter the name when prompted.

- Use the dial pad to enter a name (up to 15 characters). Each time a key is pressed, the character on that key will be displayed. Additional key presses will produce other characters on that key. See the chart below.

- Press DIR or CID to move the cursor to the right or left.
- Press **DELETE/MUTE** to erase letters.
- Press and hold **DELETE/MUTE** to erase all letters.

Dial Key	Characters by number of key presses								
	1	2	3	4	5	6	7	8	9
1	1	#	'	.	-	.	&		
2	A	B	C	2	a	b	c		
3	D	E	F	3	d	e	f		
4	G	H	I	4	g	h	i		
5	J	K	L	5	j	k	l		
6	M	N	O	6	m	n	o		
7	P	Q	R	S	7	p	q	r	s
8	T	U	V	8	t	u	v		
9	W	X	Y	Z	9	w	x	y	z
0	0								
*	*	?	!	/	()	@		
#	space								



8. Press **MENU/SELECT** to store your new directory entry. The name and the telephone number will then be shown on the screen. To change them later, see page 37.

Directory review

To review directory entries

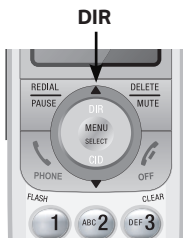

1. Press  **DIR** when in idle mode to display the first entry in the directory. **DIRECTORY EMPTY** will be displayed if there are no directory entries.

-OR-

You can also display the first entry in the directory by pressing **MENU/SELECT** twice, then pressing **MENU/SELECT** again to choose **>REVIEW**.

2. Press  **DIR** or  **CID** to browse through the directory. Entries will be displayed alphabetically by the first letter in the name.

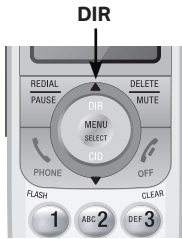

To search by name

1. Press  **DIR** when in idle mode to display the first listing in the directory. **DIRECTORY EMPTY** will be displayed if there are no directory entries.
2. When a name entry is displayed, press the dial pad keys (2-9) to start a name search.

The directory will display the first name beginning with the first letter associated with the dial pad key if there is an entry in the directory that begins with that letter.

3. To see other names that start with the letters on the same dial pad key, keep pressing the key. The names will be shown in alphabetical order.

For example, if you have the names **Jennifer**, **Jessie**, **Kevin** and **Linda** in your directory:

- If you press **5 (JKL)** once, you will see **Jennifer**.
- If you press **5 (JKL)** twice, you will see **Jessie**.
- If you press **5 (JKL)** three times, you will see **Kevin**.
- If you press **5 (JKL)** four times, you will see **Linda**.
- If you press **5 (JKL)** five times, you will see **Jennifer** again.



NOTES:

1. If there is no name matching the first letter of the key you press, you will see a name that matches the second letter of the key.
2. If you press a key (2-9) and no name starts with the letters on that key, the directory will show the entry that matches the next letter in the directory.

To dial, delete or edit entries

To dial, delete or edit a directory entry (name and number), the entry must be displayed on the handset. Use the directory search or review (pages 35-36) to display an entry.

Display dial







To dial a displayed number from the directory, press **PHONE/FLASH** or **SPEAKER**.

To delete an entry

When a directory entry is displayed, press **DELETE/MUTE** to delete the displayed entry from the directory. Once deleted, an entry cannot be retrieved.

To edit an entry

When a directory entry is displayed:

1. Press **MENU/SELECT** to modify the entry. You will be prompted to **EDIT NUMBER**.
 - Press the dial pad keys to add digits.
 - Press **DELETE/MUTE** to erase digits.
 - Press  **DIR** or  **CID** to move the cursor.
 - Press and hold **REDIAL/PAUSE** to add a three-second pause if desired.
 - Press **REDIAL/PAUSE**, then  **DIR** or  **CID** to scroll to a previously dialed number. Press **MENU/SELECT** to add the redial number to the entry.
2. Press **MENU/SELECT**. You will be prompted to **EDIT NAME**.
 - Press the dial pad keys to add characters (page 34).
 - Press **DELETE/MUTE** to erase characters.
 - Press  **DIR** or  **CID** to move the cursor.
3. Press **MENU/SELECT** to confirm.

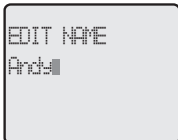
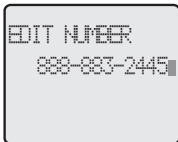

Caller ID operation



This product supports caller ID services provided by most local telephone service companies. Depending on your service subscription, you may see the caller's number, or the caller's name and number which are sent by the telephone company after the first or second ring. Caller ID allows you to see the name, number, date and time of calls.

Information about caller ID with call waiting

Caller ID with call waiting lets you see the name and telephone number of the caller before answering the telephone, even while on another call.

It may be necessary to change your telephone service to use this feature. Contact your telephone company if:

- You have both caller ID and call waiting, but as separate services (you may need to combine these services).
- You have only caller ID service, or only call waiting service.
- You don't subscribe to caller ID or call waiting services.

There are fees for caller ID services. In addition, services may not be available in all areas.



NOTE: You can use this product with regular caller ID service, or you can use this product's other features without subscribing to either caller ID or combined caller ID with call waiting service.

Depending on your service, you may see the caller's phone number or the caller's name and number.

This product can provide information only if both you and the caller are in areas offering caller ID service and if both telephone companies use compatible equipment. The time and date are sent by the telephone company along with the call information.

Caller ID operation

How the caller ID history works



The caller ID history stores information about the last 50 incoming calls. Review the caller ID history to find out who called, to easily return the call, or to copy the caller's name and number into your directory.

The phone deletes the earliest entry when the log is full to make room for new calls.

If you answer a call before the information appears on the screen, it will not be saved in the caller ID history.

The caller ID history is stored in the telephone base, and is shared by all handsets. Changes made on any one handset will be reflected in all.

NOTE: Only one handset can review the caller ID history at a time. If another handset attempts to enter the directory or caller ID history, it will display **NOT AVAILABLE AT THIS TIME**.

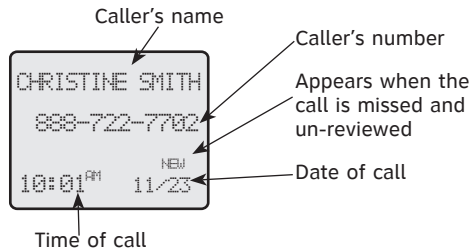

Caller ID operation



Memory match

If the incoming telephone number exactly matches a telephone number in your directory, the name that appears on the screen will match the corresponding name in your directory.

For example, if Christine Smith calls, her name will appear as **Chris** if this is how you entered it into your directory.



NOTE: The number shown by your caller ID will be in the format sent by the phone company. The phone company usually delivers ten-digit phone numbers (area code plus phone number). If the telephone number of the caller does not exactly match a number in your directory, the name will appear as it is delivered by the phone company. For example if the phone company includes the area code and the directory number does not, the name will appear as delivered by the phone company.

Missed calls indicator

When a handset is in idle mode and has calls that have not been reviewed, its screen will show **XX MISSED CALLS**.

All entries which have not been reviewed will be counted as missed calls when the phone is idle. Each time an entry in the caller ID history marked **NEW** is reviewed, the number of missed calls decreases by one.

If you have too many missed calls and you do not want to review them one by one, but you still want to keep them in the caller ID history, you can press and hold **OFF/CLEAR** for four seconds when the handset is idle. All the entries in the caller ID history will be considered old (have been reviewed), and the missed calls counter is reset to 0.

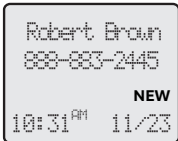
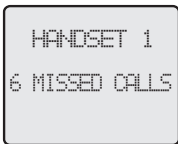

To review the caller ID history

To review the caller ID history

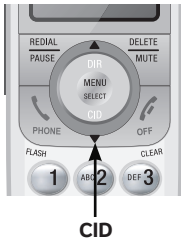

1. Press **CID** to review the caller ID history in reverse chronological order starting with the most recent call.

-OR-

You can also review the caller ID history by pressing **MENU/SELECT**, and using **DIR** or **CID** to scroll to **>CALL LOG**, then press **MENU/SELECT**.

2. Press **DIR** or **CID** to scroll through the list as shown on the left.

To dial from the caller ID history

While reviewing an entry in the caller ID history:

- Press **PHONE/FLASH** or **SPEAKER** to call the number as it is displayed in the caller ID history.
- Press **#** repeatedly to see the various dialing options (you can choose to dial with or without an area code, or with or without the 1), then press **PHONE/FLASH** or **SPEAKER** to place the call.



NOTE: You may need to change how a caller ID number will be dialed if the entry is not displayed in the correct format. Caller ID numbers may appear with an area code which may not be required for local calls, or without a 1 which may be needed for long distance calls.

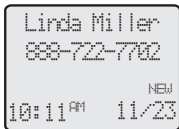
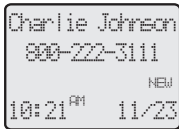
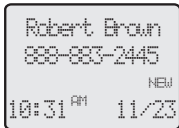

The various dialing options are:

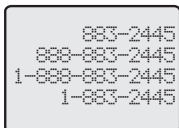

To review the caller ID history



NOTE: If neither the name nor number is provided, **UNABLE TO SAVE** will be displayed.

Other options





- Press **DELETE/MUTE** to delete the displayed entry from the caller ID history.
- With an entry from the caller ID history is displayed, press and hold **DELETE/MUTE** to delete all entries from the caller ID history. When the screen displays **DELETE ALL CALLS**, press **MENU/SELECT** to clear the caller ID history of all entries, or press **OFF/CLEAR** to exit and leave all entries in the caller ID history intact.
- Press **MENU/SELECT** to copy the entry into your directory. You can edit the name and the number (page 37).
- Press **OFF/CLEAR** to exit the caller ID history.

Screen icons, lights & tones

Screen icons & alert tones



Screen icons

-  Speakerphone is in use.
-  New voice mail messages have been received.
-  Ringer off.
- MUTE** Microphone is muted.
- NEW** Missed and unreviewed calls.
-  Battery charging (animated display).
-  Low battery (flashing); place handset in telephone base or charger to recharge.

Handset tones

- Two short beeps** **VOLUME ▼▲** keys are pressed when the volume is already at its highest or lowest setting.
- Four short beeps** Low battery warning.
- Two beeps** Out of range while the handset is on a call.
- Three rising tones** Command completed successfully.

Telephone base tones

- Beeps every 10 seconds** Message alert.
- A series of beeps** **VOLUME ▼▲** keys are pressed when the volume is already at its highest or lowest setting.

Screen icons, lights & tones

Lights

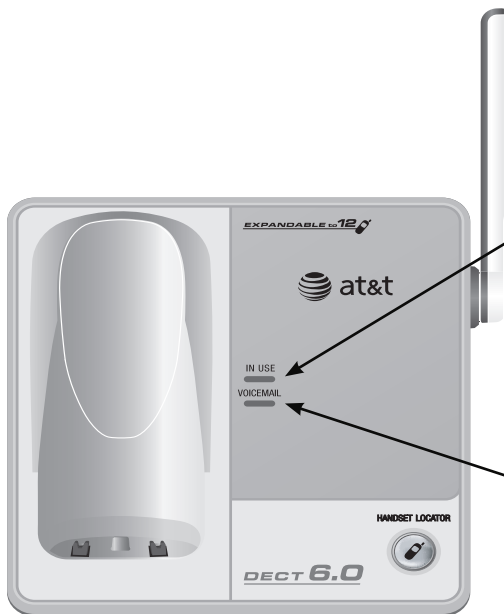

IN USE

- On when handset is in use, or when you are registering a handset.
- Flashes when another telephone is in use on the same line, or you are deregistering handset(s) from the telephone base.
- Flashes quickly when there is an incoming call.

VOICEMAIL

Flashes when you have new voice mail. Voice mail is provided by your local telephone company. It is different from the answering system on the telephone base.

CHARGE

On when the handset is charging in the telephone base or charger.

Blue backlit display

Blue backlit keypad

SPEAKER

On when the speakerphone is on.



Handset display screen messages



Screen display messages

PHONE	The handset is in use.
ENDED	You have just ended a call.
CALL LOG EMPTY	You are accessing an empty caller ID history.
DIRECTORY EMPTY	You are accessing an empty directory.
LIST FULL	The directory is full. No new entries can be saved unless some existing items are deleted.
MUTED	The microphone is muted.
SPEAKER	The handset speakerphone is in use.
LOW BATTERY	The battery needs to be recharged.
INCOMING CALL	There is a call coming in.
NEW VOICE MAIL	There are new voice mail messages.
XX MISSED CALLS	There are new calls in the caller ID history.
CONNECTING ...	The handset has lost communication with the telephone base.
** PAGING **	The telephone base is paging handset(s).
OTHER HANDSET IS CALLING (For SL81208)	The other handset is calling.
HANDSET X IS CALLING (For three or more registered handsets)	The other handset is calling.
LINE IN USE	An extension phone or one of the handsets is in use.
NO LINE	There is no telephone line connected.

Handset display screen messages



Screen display messages

CHARGING	A handset with a low battery has been placed in the telephone base or charger.
UNABLE TO CALL TRY AGAIN	Failed intercom or conference call (there are already two handsets being used).
NOT AVAILABLE AT THIS TIME	Someone else is already using the directory or caller ID history.
MICROPHONE ON	Mute has just been turned off so your voice will be heard by the other party.
INTERCOM TO: (For three or more registered handsets)	You have started the intercom process, and need to enter the number of the handset you wish to call.
INTERCOM ENDED	The intercom call has just ended.
CALLING OTHER HANDSET (For SL81208)	The handset is calling the other handset (for intercom calls). The handset is going to transfer an outside call to another handset.
CALLING HANDSET X (For three or more registered handsets)	The handset is calling the other handset (for intercom calls).
TRANSFER TO: (For three or more registered handsets)	You have started transferring a call, and need to enter the desired handset number.
NO SIGNAL, CALL ENDED	The handset is out of range while on a call.
ALREADY SAVED	The telephone number you have entered is already stored in the directory.
SAVED	The entry in caller ID history is saved to the directory successfully.

Handset display screen messages



Screen display messages

PLACE IN
CHARGER

The battery is very low. The handset should be placed in the telephone base or charger for recharging.

WARNING
CHECK BATTERY!

- The battery is not installed or not installed properly in the handset.
 - OR-
 - The battery needs to be replaced.
 - OR-
 - An incorrect battery has been installed. Use only the supplied rechargeable battery or replacement battery (model BT 8001).
-

MS X REGISTERED

The handset registration is successful.

CALL TRANSFERRED

An outside call from one handset is transferred to another handset.

Adding and registering handsets

Your telephone can accommodate up to twelve cordless handsets. You can add new handsets (SL80108, sold separately) to the SL81108/SL81208 at any time, but each new handset must be registered with the telephone base before use. Each handset must be registered separately.

The handset provided with your SL81108 is automatically registered as handset 1. Additional handsets will be assigned numbers in the order they are registered (handset 2, handset 3, handset 4 and so on). You can register eleven additional handsets.

The SL81208 has two handsets automatically registered as handset 1 and handset 2. You can register ten additional handsets, which will be assigned as handset 3, handset 4 and so on.

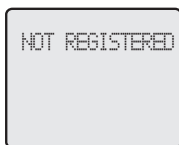

Handsets purchased separately need to be registered to the telephone base before use. When first purchased, all optional accessory handsets will show **NOT REGISTERED** on the screen. The new handset(s) may need to be charged for five minutes before registering to the telephone base.

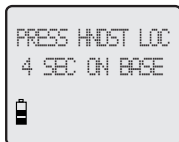

To register a handset to your telephone base

1. Place the unregistered handset into the telephone base. If **PRESS HNDST LOC 4 SEC ON BASE** does not appear on the handset screen after a few seconds, remove the handset and place it in the telephone base again.
2. On the telephone base, press and hold  **HANDSET LOCATOR** for about four seconds (until the red **IN USE** light on the telephone base turns on) and then release the button. The handset will show **PLEASE WAIT...** and it will take about 10 seconds to complete the registration. The handset will show **HS X REGISTERED** and will beep if the registration is successful.

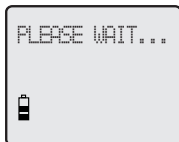

NOTES:

1. If the registration is not successful, the display will show **NOT REGISTERED**. To reset the handset, remove the handset from the telephone base and place it back in. Try the registration process again.
2. You cannot register a handset if any other system handset is in use.



Replacing a handset

You may need to de-register your handsets if:

You have twelve registered handsets and need to replace a handset.





-OR-

You wish to change the designated handset number of your registered handsets.

You must first de-register ALL the handsets, and then re-register each handset you wish to use.

Please read carefully through all the instructions on this page before beginning the de-registration process.

To de-register all handsets

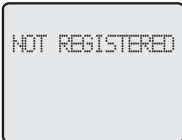

1. Press and hold  **HANDSET LOCATOR** on the telephone base for about 10 seconds (until the **IN USE** light turns on and starts to flash), then release the  **HANDSET LOCATOR** button.
2. Immediately press and release  **HANDSET LOCATOR** again. You must press  **HANDSET LOCATOR** while the **IN USE** light is still flashing. (The light flashes for about seven seconds. If the light stops flashing, pick up the handset and place it back into the telephone base, then start again with step one above.)
3. The handset(s) will show **CONNECTING...** and it will take about 10 seconds to complete the de-registration process. ALL handsets will show **NOT REGISTERED** if de-registration was successful.



4. To re-register the handset(s) to the telephone base, follow the registration instructions on page 48.



NOTES:

1. If the de-registration process was not successful, you may need to reset the system and try again. To reset: pick up the handset and press the  **PHONE/FLASH** button, then press the  **OFF/CLEAR** button and place the handset back into the telephone base. You may also reset by unplugging the power from the telephone base and plugging it back in.
2. You cannot de-register the handset(s) if any other system handset is in use.

Maintenance

Taking care of your telephone

- Your cordless telephone contains sophisticated electronic parts, so it must be treated with care.
- Avoid rough treatment.
- Place the handset down gently. Save the original packing materials to protect your telephone if you ever need to ship it.

Avoid water

- Your telephone can be damaged if it gets wet. Do not use the handset in the rain, or handle it with wet hands. Do not install the telephone base near a sink, bathtub or shower.

Electrical storms

- Electrical storms can sometimes cause power surges harmful to electronic equipment. For your own safety, take caution when using electric appliances during storms.

Cleaning your telephone

- Your telephone has a durable plastic casing that should retain its luster for many years. Clean it only with a soft cloth slightly dampened with water or a mild soap.
- Do not use excess water or cleaning solvents of any kind.

Remember that electrical appliances can cause serious injury if used when you are wet or standing in water. If the telephone base should fall into water, DO NOT RETRIEVE IT UNTIL YOU UNPLUG THE POWER CORD AND TELEPHONE LINE CORDS FROM THE WALL. Then pull the unit out by the unplugged cords.

Important safety information



This symbol is to alert you to important operating or servicing instructions that may appear in this user's manual. Always follow basic safety precautions when using this product to reduce the risk of injury, fire, or electric shock.

Safety information

- **Read and understand all instructions in the user's manual. Observe all markings on the product.**
- **Avoid using a telephone during a thunderstorm.** There may be a slight chance of electric shock from lightning.
- **Do not use a telephone in the vicinity of a gas leak.** If you suspect a gas leak, report it immediately, but use a telephone away from the area where the gas is leaking. If this product is a cordless model, make sure the telephone base is also away from the area.
- **Do not use this product near water, or when you are wet.** For example, do not use it in a wet basement or shower, or next to a swimming pool, bathtub, kitchen sink, or laundry tub. Do not use liquids or aerosol sprays for cleaning. If the product comes in contact with any liquid, unplug any line or power cord immediately. Do not plug the product back in until it has dried thoroughly.
- **Install this product in a protected location** where no one can trip over any line or power cords. Protect cords from damage or abrasion.
- **If this product does not operate normally, see the Troubleshooting section on pages 61-67 of this user's manual.** If you cannot solve the problem, or if the product is damaged, refer to the **Limited warranty** on pages 57-59. Do not open this product except as may be directed in your user's manual. Opening the product or reassembling it incorrectly may expose you to hazardous voltages or other risks.
- **Replace batteries only as described in your user's manual.** Do not burn or puncture batteries — they contain caustic chemicals.
- **This power unit is intended to be correctly oriented in a vertical or floor mount position.** The prongs are not designed to hold the plug in place if it is plugged into a ceiling or an under-the-table/cabinet outlet.



Caution: Use only the power adapter provided with this product. To obtain a replacement, visit our website at **www.telephones.att.com** or call **1 (800) 222-3111**. In Canada, dial **1 (866) 288-4268**.

Important safety information

Especially about cordless telephones:

- **Privacy:** The same features that make a cordless telephone convenient create some limitations. Telephone calls are transmitted between the telephone base and the handset by radio waves, so there is a possibility that your cordless telephone conversations could be intercepted by radio receiving equipment within range of the cordless handset. **For this reason, you should not think of cordless telephone conversations as being as private as those on corded telephones.**
- **Electrical power:** The telephone base of this cordless telephone must be connected to a working electrical outlet which is not controlled by a wall switch. **Calls cannot be made from the handset if the telephone base is unplugged or switched off, or if the electrical power is interrupted.**
- **Potential TV interference:** Some cordless telephones operate at frequencies that may cause interference to TVs and VCRs. To minimize or prevent such interference, do not place the telephone base of the cordless telephone near or on top of a TV or VCR. If interference is experienced, moving the cordless telephone farther away from the TV or VCR will often reduce or eliminate the interference.
- **Rechargeable batteries:** This product contains either nickel-cadmium or nickel-metal hydride rechargeable batteries. Exercise care in handling batteries in order not to create a short circuit with conductive material such as rings, bracelets, and keys. The battery or conductor may overheat and cause harm. Observe proper polarity between the battery and the battery charger.
- **Nickel-cadmium rechargeable batteries:** Must be recycled or disposed of properly. Do not dispose of them in household garbage. Do not burn or puncture. Like other batteries of this type, if burned or punctured, they could release caustic material which could cause injury.
- **Nickel-metal-hydride rechargeable batteries:** Dispose of these batteries in a safe manner. Do not burn or puncture. Like other batteries of this type, if burned or punctured, they could release caustic material which could cause injury.



The RBRC™ Seal means that the manufacturer is voluntarily participating in an industry program to collect and recycle nickel-metal-hydride rechargeable batteries when taken out of service within the United States. These batteries may be taken to a participating local retailer of replacement batteries or recycling center. Or you may call 1-800-8-BATTERY for locations accepting spent Ni-MH batteries.

Important safety information

Precautions for users of implanted cardiac pacemakers

Cardiac pacemakers (applies only to digital cordless telephones):

Wireless Technology Research, LLC (WTR), an independent research entity, led a multidisciplinary evaluation of the interference between portable wireless telephones and implanted cardiac pacemakers. Supported by the U.S. Food and Drug Administration, WTR recommends to physicians that:

PACEMAKER PATIENTS

- Should keep wireless telephones at least six inches from the pacemaker.
- Should NOT place wireless telephones directly over the pacemaker, such as in a breast pocket, when it is turned ON.
- Should use the wireless telephone at the ear opposite the pacemaker.

WTR's evaluation did not identify any risk to bystanders with pacemakers from other persons using wireless telephones.

Especially about telephone answering systems:

Two-way recording: This unit does not sound warning beeps to inform the other party that the call is being recorded. To ensure that you are in compliance with any federal or state regulations regarding recording a telephone call, you should start the recording process and then inform the other party that you are recording the conversation.

SAVE THESE INSTRUCTIONS

FCC Part 68 and ACTA

This equipment complies with Part 68 of the FCC rules and with technical requirements adopted by the Administrative Council for Terminal Attachments (ACTA). The label on the back or bottom of this equipment contains, among other things, a product identifier in the format US:AAAEQ##TXXXX. This identifier must be provided to your local telephone company upon request.

The plug and jack used to connect this equipment to premises wiring and the telephone network must comply with the applicable Part 68 rules and technical requirements adopted by ACTA. A compliant telephone cord and modular plug is provided with this product. It is designed to be connected to a compatible modular jack that is also compliant. An RJ11 jack should normally be used for connecting to a single line and an RJ14 jack for two lines. See Installation Instructions in the user's manual.

The Ringer Equivalence Number (REN) is used to determine how many devices you may connect to your telephone line and still have them ring when you are called. The REN for this product is encoded as the 6th and 7th characters following the US: in the product identifier (e.g., if ## is 03, the REN is 0.3). In most, but not all areas, the sum of all RENs should be five (5.0) or less. For more information, please contact your local telephone company.

This equipment may not be used with Party Lines. If you have specially wired alarm dialing equipment connected to your telephone line, ensure the connection of this equipment does not disable your alarm equipment. If you have questions about what will disable the alarm equipment, consult your telephone company or a qualified installer.

If this equipment is malfunctioning, it must be unplugged from the modular jack until the problem has been corrected. Repairs to this telephone equipment can only be made by the manufacturer or its authorized agents. For repair procedures, follow the instructions outlined under the Limited Warranty.

If this equipment is causing harm to the telephone network, the telephone company may temporarily discontinue your telephone service. The telephone company is required to notify you before interrupting service. If advance notice is not practical, you will be notified as soon as possible. You will be given the opportunity to correct the problem and the telephone company is required to inform you of your right to file a complaint with the FCC. Your telephone company may make changes in its facilities, equipment, operation, or procedures that could affect the proper functioning of this product. The telephone company is required to notify you if such changes are planned.

If this product is equipped with a corded or cordless handset, it is hearing aid compatible.

FCC Part 68 and ACTA

If this product has memory dialing locations, you may choose to store emergency telephone numbers (e.g., police, fire, medical) in these locations. If you do store or test emergency numbers, please:

Remain on the line and briefly explain the reason for the call before hanging up.

Perform such activities in off-peak hours, such as early morning or late evening.

Industry Canada

Operation is subject to the following two conditions: (1) this device may not cause harmful interference, and (2) this device must accept any interference, including interference that may cause undesired operation.

The term "IC:" before the certification/registration number only signifies that the Industry Canada technical specifications were met.

The Ringer Equivalence Number (REN) for this terminal equipment is 0.1. The REN is an indication of the maximum number of devices allowed to be connected to a telephone interface. The termination on an interface may consist of any combination of devices subject only to the requirement that the sum of the RENs of all the devices does not exceed five.

This product meets the applicable Industry Canada technical specifications.

FCC Part 15

This equipment has been tested and found to comply with the requirements for a Class B digital device under Part 15 of the Federal Communications Commission (FCC) rules. These requirements are intended to provide reasonable protection against harmful interference in a residential installation. This equipment generates, uses and can radiate radio frequency energy and, if not installed and used in accordance with the instructions, may cause harmful interference to radio communications. However, there is no guarantee that interference will not occur in a particular installation. If this equipment does cause harmful interference to radio or television reception, which can be determined by turning the equipment off and on, the user is encouraged to try to correct the interference by one or more of the following measures:

- Reorient or relocate the receiving antenna.
- Increase the separation between the equipment and receiver.
- Connect the equipment into an outlet on a circuit different from that to which the receiver is connected.
- Consult the dealer or an experienced radio/TV technician for help.

Changes or modifications to this equipment not expressly approved by the party responsible for compliance could void the user's authority to operate the equipment.

This device complies with Part 15 of the FCC Rules. Operation is subject to the following two conditions: (1) this device may not cause harmful interference, and (2) this device must accept any interference received, including interference that may cause undesired operation. Privacy of communications may not be ensured when using this telephone.

To ensure safety of users, the FCC has established criteria for the amount of radio frequency energy that can be safely absorbed by a user or bystander according to the intended usage of the product. This product has been tested and found to comply with the FCC criteria. The handset may be safely held against the ear of the user. The telephone base shall be installed and used such that parts of the user's body other than the hands are maintained at a distance of approximately 20 cm (8 inches) or more. If you choose to use a clipping device, please make sure to only use the supplied AT&T belt clip.

This Class B digital apparatus complies with Canadian ICES-003.

Limited warranty

The AT&T brand is used under license - any repair, replacement or warranty service, and all questions about this product should be directed to: In the United States of America, visit **www.telephones.att.com** or call **1 (800) 222-3111**. In Canada, call **1 (866) 288-4268**.

1. What does this limited warranty cover?

The manufacturer of this AT&T-branded product warrants to the holder of a valid proof of purchase (“CONSUMER” or “you”) that the product and all accessories provided in the sales package (PRODUCT”) are free from defects in material and workmanship, pursuant to the following terms and conditions, when installed and used normally and in accordance with the PRODUCT operating instructions. This limited warranty extends only to the CONSUMER for products purchased and used in the United States of America and Canada.

2. What will be done if the PRODUCT is not free from defects in materials and workmanship during the limited warranty period (“materially defective PRODUCT”)?

During the limited warranty period, the manufacturer’s authorized service representative will repair or replace at the manufacturer’s option, without charge, a materially defective PRODUCT. If the manufacturer repairs the PRODUCT, they may use new or refurbished replacement parts. If the manufacturer chooses to replace the PRODUCT, they may replace it with a new or refurbished PRODUCT of the same or similar design. The manufacturer will retain defective parts, modules, or equipment. Repair or replacement of the PRODUCT, at the manufacturer’s option, is your exclusive remedy. The manufacturer will return repaired or replacement products to you in working condition. You should expect the repair or replacement to take approximately 30 days.

3. How long is the limited warranty period?

The limited warranty period for the PRODUCT extends for ONE (1) YEAR from the date of purchase. If the manufacturer repairs or replaces a materially defective PRODUCT under the terms of this limited warranty, this limited warranty also applies to repaired or replacement PRODUCT for a period of either (a) 90 days from the date the repaired or replacement PRODUCT is shipped to you or (b) the time remaining on the original one-year limited warranty; whichever is longer.

Limited warranty

4. What is not covered by this limited warranty?

This limited warranty does not cover:

- PRODUCT that has been subjected to misuse, accident, shipping or other physical damage, improper installation, abnormal operation or handling, neglect, inundation, fire, water, or other liquid intrusion; or
- PRODUCT that has been damaged due to repair, alteration, or modification by anyone other than an authorized service representative of the manufacturer; or
- PRODUCT to the extent that the problem experienced is caused by signal conditions, network reliability or cable or antenna systems; or
- PRODUCT to the extent that the problem is caused by use with non-AT&T accessories; or
- PRODUCT whose warranty/quality stickers, PRODUCT serial number plates or electronic serial numbers have been removed, altered or rendered illegible; or
- PRODUCT purchased, used, serviced, or shipped for repair from outside the United States of America or Canada, or used for commercial or institutional purposes (including but not limited to products used for rental purposes); or
- PRODUCT returned without valid proof of purchase (see item 6 below); -or-
- Charges for installation or setup, adjustment of customer controls, and installation or repair of systems outside the unit.

5. How do you get warranty service?

To obtain warranty service in the United States of America, visit **www.telephones.att.com** or call **1 (800) 222-3111**. In Canada, call **1 (866) 288-4268**. NOTE: Before calling for service, please review the user's manual; a check of the PRODUCT controls and features may save you a service call.

Except as provided by applicable law, you assume the risk of loss or damage during transit and transportation and are responsible for delivery or handling charges incurred in the transport of the PRODUCT(s) to the service location. The manufacturer will return repaired or replaced PRODUCT under this limited warranty to you, transportation, delivery or handling charges prepaid. The manufacturer assumes no risk for damage or loss of the PRODUCT in transit. If the PRODUCT failure is not covered by this limited warranty, or proof of purchase does not meet the terms of this limited warranty, the manufacturer will notify you and will request that you authorize the cost of repair prior to any further repair activity. You must pay for the cost of repair and return shipping costs for the repair of products that are not covered by this limited warranty.

Limited warranty

6. What must you return with the PRODUCT to get warranty service? You must:
 - a. Return the entire original package and contents including the PRODUCT to the service location along with a description of the malfunction or difficulty; and
 - b. Include “valid proof of purchase” (sales receipt) identifying the PRODUCT purchased (PRODUCT model) and the date of purchase or receipt; and
 - c. Provide your name, complete and correct mailing address, and telephone number.
7. Other limitations

This warranty is the complete and exclusive agreement between you and the manufacturer of this AT&T branded PRODUCT. It supersedes all other written or oral communications related to this PRODUCT. The manufacturer provides no other warranties for this PRODUCT. The warranty exclusively describes all of the manufacturer’s responsibilities regarding the PRODUCT. There are no other express warranties. No one is authorized to make modifications to this limited warranty and you should not rely on any such modification.

State/Provincial Law rights: This warranty gives you specific legal rights, and you may also have other rights which vary from state to state or province to province.

Limitations: Implied warranties, including those of fitness for a particular purpose and merchantability (an unwritten warranty that the PRODUCT is fit for ordinary use) are limited to one year from date of purchase. Some states/provinces do not allow limitations on how long an implied warranty lasts, so the above limitation may not apply to you. In no event shall the manufacturer be liable for any indirect, special, incidental, consequential, or similar damages (including, but not limited to lost profits or revenue, inability to use the PRODUCT or other associated equipment, the cost of substitute equipment, and claims by third parties) resulting from the use of this PRODUCT. Some states/provinces do not allow the exclusion or limitation of incidental or consequential damages, so the above limitation or exclusion may not apply to you.

Please retain your original sales receipt as proof of purchase.

Technical specifications

RF frequency band	1921.536 MHz — 1928.448 MHz
Channels	5
Operating temperature	32°F — 122°F 0°C — 50°C
Telephone base voltage (AC voltage, 60Hz)	96 — 127 Vrms
Telephone base voltage (AC adapter output)	6VDC @300mA
Handset voltage	2.2 — 3.0 VDC
Charger voltage (AC adapter output)	6VDC @200mA
Replacement battery	2.4V 500mAH

DECT 6.0 digital technology

This technology digitally transmits your voice across multiple channels using the newly available DECT 6.0 frequency band. This technology provides superior quality of voice and sound, high protection against wiretapping and better range than the 2.4 GHz and 5.8 GHz phone systems, while not interfering with wireless routers.

Telephone operating range

This cordless telephone operates within the maximum power allowed by the Federal Communications Commission (FCC). Even so, this handset and telephone base can communicate over only a certain distance — which can vary with the locations of the telephone base and handset, the weather, and the construction of your home or office.

Extended range and clarity

This telephone base comes with an antenna which gives much better clarity and covers a longer range than before.

Troubleshooting

If you have difficulty with your phone, please try the suggestions below. For Customer Service, visit our website at **www.telephones.att.com** or call **1 (800) 222-3111**. In Canada, dial **1 (866) 288-4268**.

My phone doesn't work at all.	<ul style="list-style-type: none">• Make sure the power cord is securely plugged in.• Make sure that the battery connector is securely plugged into the cordless handset.• Make sure the telephone line cord is securely and firmly plugged into the telephone base and the telephone wall jack.• Charge the battery in the cordless handset for at least 16 hours. For optimum daily performance, return the cordless handset to the telephone base or charger when not in use.• Reset the telephone base. Unplug the unit's electrical power. Wait for approximately 15 seconds, then plug it back in. Allow up to one minute for the cordless handset and telephone base to reset.• You may need to purchase a new battery, please refer to Battery installation and charging, page 8, in this user's manual.
I cannot get a dial tone.	<ul style="list-style-type: none">• First try all the suggestions above.• Move the cordless handset closer to the telephone base. You might have moved out of range.• If the previous suggestions don't work, disconnect the telephone base from the telephone jack and connect to a different phone. If there is no dial tone on that phone either, the problem is in your wiring or local service. Contact your local telephone company.• Your line cord might be malfunctioning. Try installing a new line cord.
I cannot dial out.	<ul style="list-style-type: none">• First try all the suggestions above.• Make sure you have a dial tone before dialing. The cordless handset may take a second or two to find the telephone base and produce a dial tone. This is normal. Wait an extra second before dialing.

Troubleshooting

- Eliminate any background noise. Noise from a television, radio or other appliances may cause the phone to not dial out properly. If you cannot eliminate the background noise, first try muting the cordless handset before dialing, or dialing from another room in your home with less background noise.
 - If the other phones in your home are having the same problem, the problem is in your wiring or local service. Contact your local telephone company (charges may apply).
-

My cordless handset isn't performing normally.

- Make sure the power cord is securely plugged into the telephone base. Plug the unit into a different, working electrical outlet not controlled by a wall switch.
 - Move the cordless handset closer to the telephone base. You might have moved out of range.
 - Reset the telephone base. Unplug the unit's electrical power. Wait for 15 seconds then plug it back in. Allow up to one minute for the cordless handset and telephone base to reset.
 - Other electronic products can cause interference to your cordless phone. Try installing your phone as far away from these types of electronic devices as possible: television sets, VCRs, or other cordless telephones.
-

CONNECTING...
displays on my cordless handset.

- Ensure that the telephone base is powered up.
- Place the cordless handset in the telephone base for one minute to allow the cordless handset and base to resynchronize.
- Move the cordless handset closer to the telephone base. You might have moved out of range.

Troubleshooting

- Reset the telephone base. Unplug the unit's electrical power. Wait for 15 seconds then plug it back in. Allow up to one minute for the cordless handset and telephone base to reset.
 - Other electronic products can cause interference with your cordless phone. Try installing your phone as far away from these types of electronic devices as possible: television sets, VCRs, or other cordless telephones.
-

The batteries will not hold a charge.

- If the cordless handset is in the telephone base or charger and the charge light does not come on, refer to **The charge light is off** in this **Troubleshooting** guide.
 - Charge the battery in the cordless handset for at least 16 hours. For optimum daily performance, return the cordless handset to the telephone base or charger when not in use.
 - You may need to purchase a new battery. Please refer to **Battery installation and charging**, page 8, in this user's manual.
-

I get noise, static, or weak signals even when I'm near the telephone base.

- If you subscribe to high-speed internet service (Digital Subscriber Line - DSL) through your telephone lines, you must have a DSL filter between the telephone base and the telephone wall jack (see the following page). The filter will prevent noise and caller ID problems caused by DSL interference. Please contact your DSL service provider for more information about DSL filters.
- You may be able to improve the performance of your cordless phone by installing your new telephone base as far as possible from any other existing cordless telephone system that may already be installed.
- Other electronic products can cause interference to your cordless phone. Try installing your phone as far away from the following electronic devices as possible: television sets, VCRs, or other cordless telephones.

Troubleshooting

- Do not install this phone near a microwave oven or on the same electrical outlet. You may experience decreased performance while the microwave oven is operating.
- If your phone is plugged in with a modem or a surge protector, plug the phone (or modem/surge protector) into a different location. If this solves the problem, re-locate your phone or modem farther apart from one another, or use a different surge protector.
- Relocate your phone to a higher location. The phone will likely have better reception when installed in a high area.
- If the other phones in your home are having the same problem, the problem is in your wiring or local service. Contact your local telephone company (charges may apply).

I hear other calls while using my phone.

- Disconnect the telephone base from the telephone jack, and plug in a different telephone. If you still hear other calls, the problem is probably in your wiring or local service. Call your local telephone company.

My cordless handset does not ring when I receive a call.

- Make sure that the ringer is not turned off. Refer to the section(s) on ringer selection in this user's manual.
- Make sure the telephone line cord is plugged securely into the telephone base and the telephone jack. Make sure the power cord is securely plugged in.
- The cordless handset may be too far from the telephone base.
- Charge the battery in the cordless handset for at least 16 hours. For optimum daily performance, return the cordless handset to the telephone base or charger when not in use.
- You may have too many extension phones on your telephone line to allow all of them to ring simultaneously. Try unplugging some of the other phones.

Troubleshooting

- The layout of your home or office might be limiting the operating range. Try moving the telephone base to another location, preferably on an upper floor.
- If the other phones in your home are having the same problem, the problem is in your wiring or local service. Contact your local telephone company (charges may apply).
- Test a working phone at the phone jack. If another phone has the same problem, the problem is the phone jack. Contact your local telephone company (charges may apply).
- Other electronic products can cause interference with your cordless phone. Try installing your phone as far away as possible from electronic devices such as television sets, VCRs, or other cordless telephones.
- Re-install the battery, and place the cordless handset in the telephone base. Wait for the cordless handset to re-establish its connection with the telephone base. Allow up to one minute for this to take place.
- Your line cord might be malfunctioning. Try installing a new line cord.

My calls cut in and out while I'm using my cordless handset.

- Other electronic products can cause interference with your cordless phone. Try installing your phone as far away from the following electronic devices as possible: television sets, VCRs, or other cordless telephones.
- Do not install this phone near a microwave oven or on the same electrical outlet. You may experience decreased performance while the microwave oven is operating.
- If your phone is plugged in with a modem or surge protector, plug the phone (or modem/surge protector) into a different location. If this solves the problem, re-locate your phone or modem farther apart from one another, or use a different surge protector.

Troubleshooting

- Relocate your telephone base to a higher location. The phone will have better reception when installed in a high area.
- If the other phones in your home are having the same problem, the problem is in your wiring or local service. Contact your local telephone company (charges may apply).

The charge light is off.

- Make sure the power and line cords are plugged in correctly and securely.
- Unplug the unit's electrical power. Wait for 15 seconds, then plug it back in. Allow up to one minute for the cordless handset and telephone base to reset.
- Clean the cordless handset and telephone base charging contacts each month using a pencil eraser or cloth.

My caller ID isn't working.

- Caller ID is a subscription service. You must subscribe to this service from your local telephone company for this feature to work on your phone.
- Your caller must be calling from an area that supports caller ID.
- Both you and your caller's telephone companies must use caller ID compatible equipment.
- If you subscribe to high-speed internet service (Digital Subscriber Line - DSL) through your telephone lines, you must have a DSL filter between the telephone base and the telephone wall jack (see the following page). The filter will prevent noise and caller ID problems caused by DSL interference. Please contact your DSL service provider for more information about DSL filters.

System does not receive caller ID when on a call.

- Make sure you subscribe to caller ID with call waiting features provided by your local telephone company. Caller ID features will work only if both you and the caller are in areas offering caller ID service, and if both telephone companies use compatible equipment.

Troubleshooting

Common cure for electronic equipment.

If the unit does not seem to be responding normally, try putting the cordless handset in the telephone base or charger. If it does not seem to respond, do the following (in the order listed):

- Disconnect the power to the telephone base.
- Disconnect the cordless handset battery, and spare battery, if applicable.
- Wait a few minutes.
- Connect power to the telephone base.
- Re-install the battery, and place the cordless handset into the telephone base.
- Wait for the cordless handset to re-establish its connection with the telephone base. Allow up to one minute for this to take place.

Index

A

AC adapter, 5
Alert tones, 43
Answering calls, 22
Auto off, 23

B

Battery charging, 7
Battery installation, 7
Belt clip, 9

C

Call transfer, 30
Call waiting, 25
Caller ID (CID), 38
 add entries to phone directory, 42
 delete entries, 42
 dial entries, 41
Clear voice mail indication, 20

D

Deregistration, 49
Delete entries in the
 call ID history, 42
Delete redial entries, 23
Dialing,
 from a record in the
 caller ID history, 41
 directory dialing, 37
Directory, 32
 dial number, 37
 edit entries, 37
 name search, 36
 new entries, 33-34
Display dial, 37
DSL, 5

E

Elapsed time, 22
Ending calls, 22

F

Flash (switchhook flash), 25

H

Hands speakerphone, 22
Handset key tone, 18
Handset language, 19
Handset locator, 24
Handset ringer tone, 18
Handset ringer volume, 17
Handset settings, 17-21
Handset voicemail indicator, 20
Headset, 9

I

Intercom, 28
Incoming caller ID history, 41
Incoming calls, answering, 22

L

Language, 19
Last number redial, 26
Lights, 44

M

Making calls, 22
Memory match, 40
Missed calls indicator, 40
Mute, 26

N

Names,
 enter into directory, 34
 search for, 36

O

On-hook dialing, 22

Index

Q

Quick reference guide, 2-3

R

Receiving calls, 22

Redial, 26

Registration, 48

Ringer silencing, 21

Ring tone options, 18

Ringer volume, handset, 17

S

Search for names, 36

Speakerphone, 22

T

Technical specifications, 60

Telephone operating range, 60

Temporary ringer silencing, 21

Troubleshooting, 61-67

V

Visual message waiting indicator, 20

Voicemail, 3, 44

Volume controls, 17, 25



www.telephones.att.com