



at&t

SynJ™

User's manual

SynJ SB67108

**DECT 6.0 expansion handset
for use with AT&T model
SynJ SB67118/SB67138**



Congratulations

on your purchase of this AT&T product. Before using this AT&T product, please read **Important safety information** on pages 68-70 of this manual. Please thoroughly read this user's manual for all the feature operations and troubleshooting information necessary to install and operate your new AT&T product. You can also visit our website at **www.telephones.att.com** or call **1 (888) 915-2007**. In Canada, dial **1 (866) 288-4268**.

Model number: SynJ™ SB67108

Type: DECT 6.0 expansion handset

Serial number: _____

Purchase date: _____

Place of purchase: _____

Both the model and serial number of your AT&T product can be found on the bottom of the charger.

Save your sales receipt and original packaging in case it is necessary to return your telephone for warranty service.

Compatible with
Hearing Aid T-Coil



Telephones identified with this logo have reduced noise and interference when used with most T-coil equipped hearing aids and cochlear implants. The TIA-1083 Compliant Logo is a trademark of the Telecommunications Industry Association. Used under license.

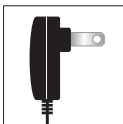

Powered by an
ENERGY STAR®
qualified adapter
for a better
environment

The ENERGY STAR® program (www.energystar.gov) recognizes and encourages the use of products that save energy and help protect our environment. We are proud to supply this product with an ENERGY STAR® qualified power adapter meeting the latest energy efficiency guidelines.

Parts checklist

Check to make sure the telephone package includes the following items:

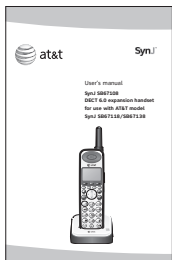

User's manual



Quick start guide



Cordless handset

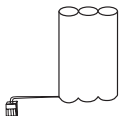

Battery for cordless handset



Battery compartment cover

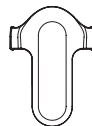

Belt clip for cordless handset



Charger for cordless handset with power adapter installed

User's manual

SynJ SB67108

DECT 6.0 expansion handset

for use with AT&T model

SynJ SB67118/SB67138



Table of contents

Getting started

Quick reference guide	1
Installation.....	3
Charger installation	4
Handset battery installation and charging.....	5
Low battery indicator.....	7
Add and register handsets.....	8
To register a handset to your SynJ SB67118 telephone base.....	8
To register a handset to your SynJ SB67138 telephone base.....	9
Deregister all handsets	10
Belt clip and optional headset...	11
Handset setup.....	12
Menu settings	12
Ringer volume	12
Ringer tone	13
LCD contrast.....	13
Key tone	14
Language	14
Line selection.....	15
Change handset name	15
Hold reminder.....	16

Speed dial.....	17
Customer support.....	17
Screen icons, indicator tones and lights.....	18
Mailbox setup.....	19
Handset mailbox overview	19
Fast answer mode on or off...	19
Set access code (remote access code) and mailbox security	19
Notify alert.....	20
Announcement setup	22

Handset operation

Handset basic operation	23
Making a call.....	23
On hook dialing (predialing)...	23
Using the speakerphone	23
Calling a speed dial number...	24
Answering a call.....	24
Ringer volume	24
Temporary ringer silencing ...	25
Auto off.....	25
Last number redialing.....	26
Options while on calls.....	27
Volume control.....	27

Call waiting.....	27
Call privacy.....	27
Recording a call.....	28
Mute.....	29
Hold.....	30
Switching between lines.....	30
Join a call in progress.....	31
Chain dialing.....	31
Three-way conference calls.....	32
COVM.....	34
COVM (central office voicemail).....	34
Intercom.....	35
Make an intercom call.....	35
Answer an incoming call during an intercom call.....	36
Answer an intercom call.....	36
End an intercom call.....	36
Call transfer using intercom.....	37
Push to talk (PTT) intercom.....	38
PTT call to a single device.....	38
PTT call to all devices.....	39
Answer a PTT call.....	39
Convert PTT call to intercom call.....	40
End PTT call.....	40

Directory

About the directory.....	41
Capacity.....	41
Exit the directory.....	41
Create directory entries.....	42
Create and store a directory entry.....	42
Store a pause in a directory number.....	43
Store a flash in a directory number.....	44
Review directory.....	45

Review directory entries.....	45
Search directory.....	46
Search by name.....	46
Dial, delete or edit entries.....	47
Display dial.....	47
Delete an entry.....	47
Delete all entries.....	47
Edit an entry.....	47

Caller ID

About caller ID (call log).....	48
Information about caller ID with call waiting.....	48
Caller ID history.....	49
How caller ID history (call log) works.....	49
Caller ID operation.....	51
Memory match.....	51
Missed (new) calls indicator.....	51
Review caller ID history.....	52
Make a call log entry ready to dial.....	52
Dial a call log entry.....	53
Delete entries.....	53
Save a call log entry to the directory.....	54
Reasons for missing caller ID information.....	55

Answering system

Handset voicemail box (answering system).....	56
Answering system and voicemail.....	56
Setting your system to automatically answer calls.....	57
Record announcement.....	57
Answering system capacity.....	57
Voice prompts.....	58

New message indication	58
Turn alert on or off.....	58
Message playback.....	59
Options during playback.....	60
Delete all old messages.....	60
Recording and delivering memos.....	62
Remote access	63

Appendix

Handset display screen messages	65
Maintenance	67
Important safety information....	68
FCC part 68 and ACTA	71
FCC part 15.....	73
Limited warranty.....	74
Technical specifications	77
Troubleshooting.....	78

Index

Index.....	88
------------	----

Quick reference guide

Softkeys

Press to select an item displayed above the key.

L 1-L 4 keys

Press to make or answer a call on the desired line (pages 23-24).

SPK / SPKR

Press to turn on the handset speakerphone (page 23). Press again to turn off.

PHONE/FLASH

Press to make or answer a call (pages 23-24).

During a call, press to answer an incoming call when you receive a call waiting alert (page 27).

MUTE

During a call, press to mute the microphone (page 29).

During an incoming call, press to mute the ringer (page 25).

Navigation key (Navkey)

While in menus, press **▲DIR** or **CID▼** to scroll through the menus, highlight items or to change settings. Press **◀** to return to the previous menu.

While entering names or numbers, press **◀** or **▶** to move the cursor to the left or right.

MENU/ENTER

Press to enter menus. While in the menus, press to select an item or save an entry or setting.

HOLD

Press to place an outside call on hold (page 30).

OFF/CLEAR

During a call, press to hang up (page 23). While using menus, press to cancel an operation, exit the menu display, or return to idle mode. While in editing mode, press to delete a character.

REDIAL/PAUSE

Press repeatedly to view the last 10 numbers dialed (page 26). While entering numbers, press to insert a dialing pause (page 43).

INT

Press to begin an intercom call or to transfer a call (pages 35-38).

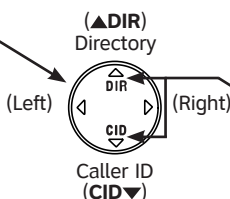
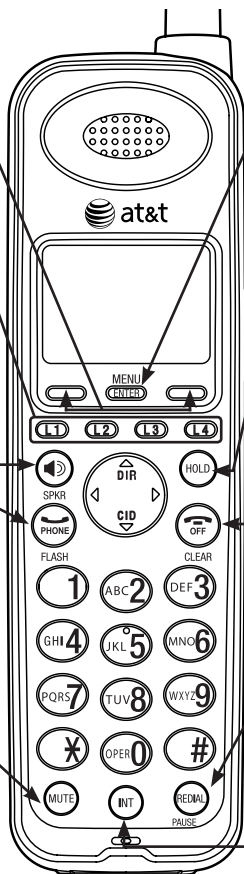

▲DIR/CID▼

When in idle mode, press **▲DIR** to display directory entries, or press **CID▼** to display the caller ID information (page 52).

Quick reference guide

PTT (push-to-talk)

Press and release, then press **▲DIR** or **CID▼** to select an extension. Press and hold to broadcast your voice to that extension or to the base (page 38).

Press and hold to broadcast your voice to all extensions (page 39).

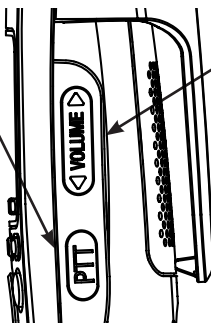

VOLUME ▲▼

During a call, press to adjust the listening volume (page 27).

During message playback, press to adjust the playback volume (page 60).

Main menu

The > symbol highlights a menu item.



Menu

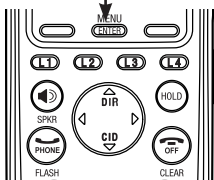

Main menu

- Directory (page 41)
- Call log (page 48)
- Ringer setting (page 12)
- Mailbox setup (page 19)
- Handset setup (page 12)
- COVM (central office voicemail, page 34)
- Speed dial setup (page 17)
- Customer support (page 17)

Using menus

- Press **MENU/ENTER** to show the first menu item, **Directory**.
- Press **▲DIR** or **CID▼** to scroll through menu items.
- Press **MENU/ENTER** to select or save changes to a highlighted menu item.
- Press **OFF/CLEAR** to cancel an operation, exit the menu display, or return to idle mode.
- Press the **Back** softkey or **◀** to back up to the previous menu.

Installation

If you subscribe to high-speed Internet service (DSL - digital subscriber line) through your telephone line, you must install a DSL filter between the telephone line cord and the telephone wall jack. The filter prevents noise and caller ID problems caused by DSL interference. Please contact your DSL service provider for more information about DSL filters.

Your product may be shipped with a protective sticker covering the handset display - remove it before use.

For customer service or product information, visit our website at **www.telephones.att.com** or call **1 (888) 915-2007**. In Canada, dial **1 (866) 288-4268**.

Avoid placing the handset and charger too close to:

- Communication devices such as: television sets, VCRs, or other cordless telephones.
- Excessive heat sources.
- Noise sources such as a window with traffic outside, motors, microwave ovens, refrigerators, or fluorescent lighting.
- Excessive dust sources such as a workshop or garage.
- Excessive moisture.
- Extremely low temperature.
- Mechanical vibration or shock such as on top of the washing machine or work bench.

Charger installation

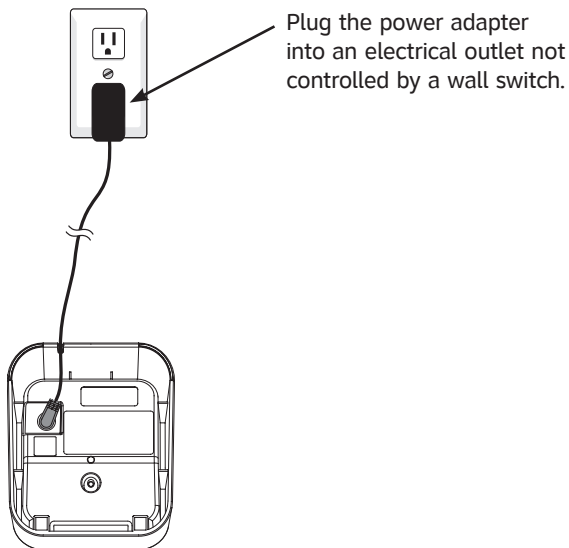

IMPORTANT INFORMATION

1. Use only the power adapter supplied with this product. To order a replacement power adapter, visit our website at www.telephones.att.com, or call **1 (888) 915-2007**. In Canada, dial **1 (866) 288-4268**.
2. The power adapter is intended to be correctly oriented in a vertical or floor mount position. The prongs are not designed to hold the plug in place if it is plugged into a ceiling, under-the-table or cabinet outlet.

Handset battery installation and charging

Install the battery as shown on the next page. Once you have installed the battery, the screen indicates the battery status (see table below). If necessary, place the handset in the charger to charge the battery. For best performance, keep the handset in the charger when not in use. The battery is fully charged after 16 hours of continuous charging. See the table on page 77 for battery operating times.

If the screen is blank, you need to charge the handset without interruption for at least 10 minutes to give the handset enough charge to use the telephone for a short time. The screen flashes **Low battery** until you have charged the battery without interruption for at least one hour. The following table summarizes the battery charge indicators and actions to take.

Battery indicators	Battery status	Action
The screen is blank.	Battery has no charge and the handset cannot be used.	Charge without interruption for at least 10 minutes. The screen shows Charging .
The screen shows Low battery .  flashes, and the handset beeps.	Battery has enough charge to be used for a short time.	Charge without interruption at least one hour.
The screen shows Charge completed .	Battery is fully charged.	To keep the battery charged, place it in the charger when not in use.



NOTE: In low battery mode, you hear four short beeps per minute.

Handset battery installation and charging



Step 1

Plug the battery connector securely into the socket inside the handset battery compartment, matching the color-coded label. Insert the supplied battery with the label **THIS SIDE UP** facing up as indicated.



Step 2

Align the cover flat against the battery compartment, then slide it upwards.

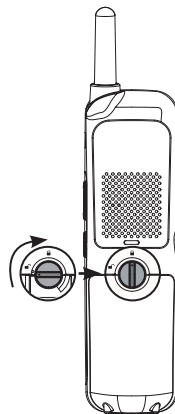

Step 3

To lock the battery compartment, turn the latch clockwise until it points to the lock icon  as shown above.

Handset battery installation and charging

Step 4

To charge the handset, place it in the charger as shown. The **CHARGE** light is on when the handset is charging.



Low battery indicator

Return the handset to the charger to recharge when the handset screen displays **Low battery**.

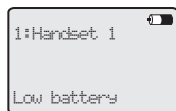

To open the battery compartment for battery replacement, turn the latch counter-clockwise until it reaches the horizontal position as shown to the right. Slide the battery compartment cover downwards. Lift out the old battery and disconnect it from the handset. Follow the instructions on pages 6-7 to install and charge the new battery.

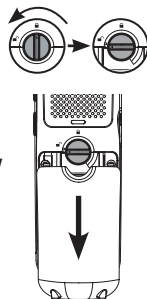

IMPORTANT INFORMATION

1. Use only the supplied rechargeable battery or replacement battery (model 27910). To order, visit our website at **www.telephones.att.com** or call **1 (888) 915-2007**. In Canada, dial **1 (866) 288-4268**.
2. If you do not use the handset for a long time, disconnect and remove the battery to prevent possible leakage.

Add and register handsets

The handset provided with your SynJ SB67118/SB67138 is already registered as **Handset 1**. Additional handsets are assigned numbers in the order they are registered (**Handset 2** to **Handset 10**). You can register a maximum of 10 handsets.

You can add new handsets (SynJ SB67108, sold separately) to the SynJ SB67118/SB67138 at any time, but each new handset must be registered with the telephone base before use. Each handset must be registered separately.

If the handset does not have enough power to proceed with the registration, you need to charge the new handset for at least five minutes (see page 7). Start registration when the handset screen shows **Press MENU on BS, sel Registration & sel Register HS. Then put HS in cradle.**

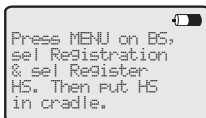

To register a handset to your SynJ SB67118 telephone base

1. Make sure the handset is out of the charger and the screen shows **Press MENU on BS, sel Registration & sel Register HS. Then put HS in cradle.**
2. On the telephone base, press **MENU/ENTER**.
3. Scroll down to **Registration** and press **MENU/ENTER**.
4. Press **MENU/ENTER** again to select **Register HS**.
5. Place the unregistered handset into the charger. The telephone base screen shows **Handset registering**. It takes up to 60 seconds to complete the registration. You will hear a beep when the registration is successful. The handset shows **Handset registered**, and then shows **X:Handset X** (X represents the extension number [1-0]; **Handset X** represents the default handset name).

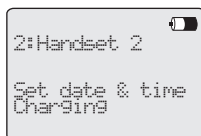
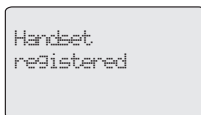
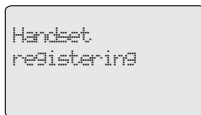
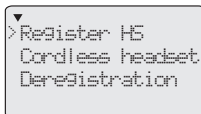
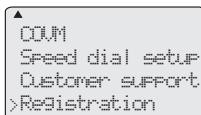

Add and register handsets

To register a handset to your SynJ SB67138 telephone base

1. Make sure the handset is out of the charger and the screen shows **Press MENU on BS, sel Registration & sel Register HS. Then put HS in cradle.**
2. On the telephone base, press **MENU/ENTER**.
3. Scroll down to **Registration** and press **MENU/ENTER**.
4. Press **MENU/ENTER** again to select **Register HS**.
5. Place the unregistered handset into the charger. The telephone base screen shows **Registering new device...** It takes up to 60 seconds to complete the registration. There is a beep sound when the registration is successful. The telephone base shows **Handset registered** and then the handset shows **X:Handset X** (**X** represents the extension number [**1-0**]; **Handset X** represents the default handset name).

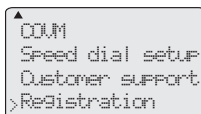

▲
 CDM
 Speed dial setup
 Customer support
 >Registration

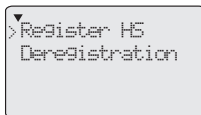

▼
 >Register HS
 Deregistration



Registering
 new device...

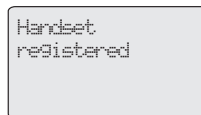

Handset
 registered

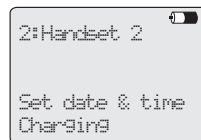

2:Handset 2 
 Set date & time
 Charging

NOTES:

1. If the registration is not successful, the screen shows **Press MENU on BS, sel Registration & sel Register HS. Then put HS in cradle.** To reset the handset, remove the handset from the charger. Try the registration process again.
2. Please make sure to remove all unregistered system handsets or cordless headsets from the chargers before registering a new handset.

Deregister all handsets

You may need to deregister your handsets if you already have ten registered devices and need to replace a handset, or if you wish to change the assigned numbers of your registered handsets.

You must first deregister ALL the devices, and then register each handset that you wish to use again, one at a time.

Please read carefully through all the instructions in this section before beginning the deregistration process.

This process deregisters all extensions registered to the telephone base. Please make sure the telephone system is not in use before deregistration.

1. On the telephone base, press **MENU/ENTER**.
2. Scroll down to **Registration** and press **MENU/ENTER**.
3. Scroll down to **Deregistration** and press **MENU/ENTER**.
4. The telephone base screen shows **Deregister all handsets? <=No =>Yes**. Press **◀REP** to exit or press **SKIP▶** to continue the deregistration.
5. The telephone base screen shows **Deregistering**. It takes up to 10 seconds to complete the deregistration. The screen shows **All handsets deregistered** and the telephone base beeps when deregistration is successful.

```

^
COUM
Speed dial setup
Customer support
>Registration
  
```

```

^
HS registration
Cordless headset
>Deregistration
  
```

↑
SB67118 base screen

```

Register HS
>Deregistration
  
```

↑
SB67138 base screen

```

Deregister all
handsets?
<=No      =>Yes
  
```

```

Deregistering
  
```

```

All handsets
deregistered
  
```

NOTES:

1. If the deregistration process is not successful, you might need to reset the system and try again. To reset: pick up the handset and press **PHONE/FLASH**, then press **OFF/CLEAR** and place the handset back into the charger. You can also reset the telephone base by unplugging the power from the telephone base and plugging it back in.
2. To register a cordless handset again, see pages 8-9.

Belt clip and optional headset

Install the belt clip as shown below if desired.

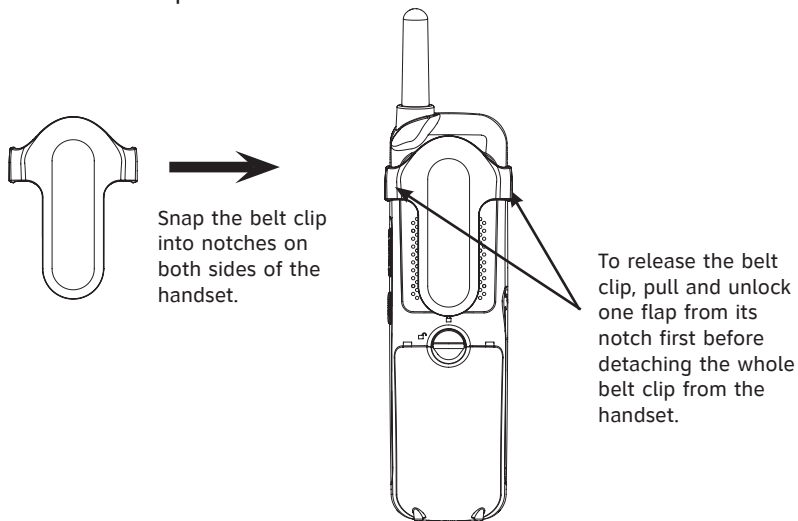

To use an AT&T 2.5 mm headset, plug it into the jack on the side of the handset as shown below.

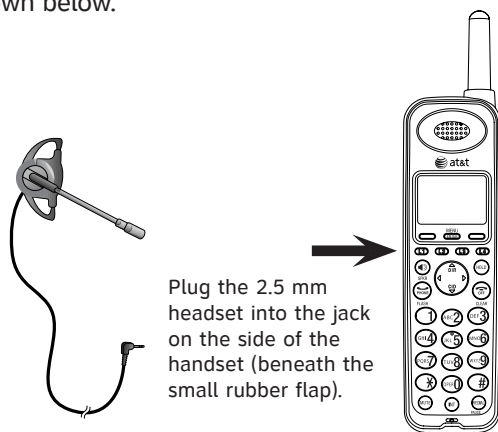

Handset setup

Menu settings

You can use the menus to change the handset settings.

1. Press **MENU/ENTER** when in idle mode (when the phone is not in use) to enter the main menu.
2. Press **▲DIR** or **CID▼** to scroll to the feature to be changed. The **>** symbol indicates the selected menu item.
3. Press **MENU/ENTER** to select the menu item.
4. Press **☎ OFF/CLEAR** to exit setup without making changes.



NOTE: Press **☎ OFF/CLEAR** to cancel an operation, exit the menu display, or return to idle mode.

Ringer volume

You can set the ringer volume level (1-3), or turn the ringer off. When the ringer is off,  appears on the handset screen.

1. When the handset is idle, press **MENU/ENTER**.
2. Press **▲DIR** or **CID▼** to scroll to **Ringer setting**.
3. Press **MENU/ENTER** twice to select **Ringer volume**.
4. Press **▲DIR** or **CID▼** to adjust the ringer volume.
5. Press **MENU/ENTER** to save the setting and return to the previous menu. There is a confirmation tone. To exit without making changes, press **☎ OFF/CLEAR**.

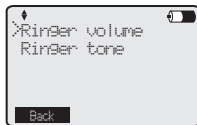

NOTE: The ringer volume also determines the ringer volume for intercom calls (page 35). If the handset ringer volume is set to off, that handset is silenced for all incoming calls.

Handset setup

Ringer tone

You can choose one of seven ringer tones for incoming calls. You can choose different ringer tones for different lines so you can easily identify which line is ringing.

1. When the handset is idle, press **MENU/ENTER**.
2. Press **▲DIR** or **CID▼** to scroll to **Ringer setting**. Press **MENU/ENTER**.
3. Press **▲DIR** or **CID▼** to scroll to **Ringer tone**. Press **MENU/ENTER**.
4. Press **◀** or **▶** to select the desired line (**L1, L2, L3, L4**).
5. Press **▲DIR** or **CID▼** to select the desired ringer tone.
6. To move to another line, press **◀** or **▶**.
7. Press **MENU/ENTER** to save the setting and return to the previous menu. There is a confirmation tone. To exit without making changes, press **OFF/CLEAR**.



NOTE: If you turn off the ringer volume, you do not hear ringer tone samples.

LCD contrast

You can adjust the screen contrast to one of six levels to optimize readability in different lighting conditions.

1. When the handset is idle, press **MENU/ENTER**.
2. Press **▲DIR** or **CID▼** to scroll to **Handset setup**.
3. Press **MENU/ENTER** twice to select **LCD contrast**.
4. Press **▲DIR** or **CID▼** to adjust the screen contrast level.
5. Press **MENU/ENTER** to save the setting and return to the previous menu. There is a confirmation tone. To exit without making changes, press **OFF/CLEAR**.

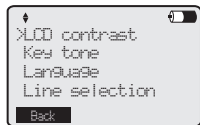

Handset setup

Key tone

Use this feature to turn the key tone on and off. The handset is factory set to beep with each key press. You can turn off this beep sound by turning the key tone off.

1. When the handset is idle, press **MENU/ENTER**.
2. Press **▲DIR** or **CID▼** to scroll to **Handset setup**.
Press **MENU/ENTER**.
3. Press **▲DIR** or **CID▼** to scroll to **Key tone**.
Press **MENU/ENTER**.
4. Press **▲DIR** or **CID▼** to select **On** or **Off**.
5. Press **MENU/ENTER** to save the setting and return to the previous menu. There is a confirmation tone. To exit without making changes, press **OFF/CLEAR**.

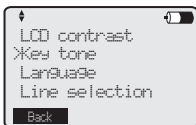

Language

You can select the language used for all screen displays of this handset only.

1. When the handset is idle, press **MENU/ENTER**.
2. Press **▲DIR** or **CID▼** to scroll to **Handset setup**.
Press **MENU/ENTER**.
3. Press **▲DIR** or **CID▼** to scroll to **Language**.
Press **MENU/ENTER**.
4. Press **▲DIR** or **CID▼** to select **English** or **Español**.
5. Press **MENU/ENTER** to save the setting and return to the previous menu. There is a confirmation tone. To exit without making changes, press **OFF/CLEAR**.



Handset setup

Line selection

You can select the default telephone line to be used when you make outgoing calls. This handset comes factory set for **Auto** selectable line, which chooses the first available line for making a call. To select a particular line, choose **Line 1**, **Line 2**, **Line 3** or **Line 4**.

1. When the handset is idle, press **MENU/ENTER**.
2. Press **▲DIR** or **CID▼** to scroll to **Handset setup**. Press **MENU/ENTER**.
3. Press **▲DIR** or **CID▼** to scroll to **Line selection**. Press **MENU/ENTER**.
4. Press **▲DIR** or **CID▼** to select **Auto**, **Line 1**, **Line 2**, **Line 3** or **Line 4**.
5. Press **MENU/ENTER** to save the setting and return to the previous menu. There is a confirmation tone. To exit without making changes, press **OFF/CLEAR**.

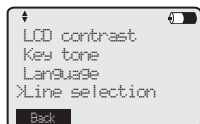

Change handset name

You can create a handset name for each registered handset.

1. When the handset is idle, press **MENU/ENTER**.
2. Press **▲DIR** or **CID▼** to scroll to **Handset setup**. Press **MENU/ENTER**.
3. Press **▲DIR** or **CID▼** to scroll to **Handset name**. Press **MENU/ENTER**.
4. Change the handset name when prompted.
 - Press **◀** or **▶** to move the cursor to the left or right.
 - Use the dial pad to enter a name (up to 13 characters). Each time you press a key, a character on that key appears. Additional key presses produce other characters on that key. See the chart on page 43.
 - Press **OFF/CLEAR** to backspace and delete characters.
 - Press and hold **OFF/CLEAR** to delete all characters.
5. Press **MENU/ENTER** to save the setting and return to the previous menu. There is a confirmation tone. To exit without making changes, press **OFF/CLEAR**.



Handset setup

Hold reminder

When there is a call on hold for more than three minutes, the handset gives you a reminder beep once every 30 seconds. You can also turn this setting off.

1. When the handset is idle, press **MENU/ENTER**.
2. Press **▲DIR** or **CID▼** to scroll to **Handset setup**.
Press **MENU/ENTER**.
3. Press **▲DIR** or **CID▼** to scroll to **Hold Reminder**.
Press **MENU/ENTER**.
4. Press **▲DIR** or **CID▼** to select **On** or **Off**.
5. Press **MENU/ENTER** to save the setting and return to the previous menu. There is a confirmation tone. To exit without making changes, press **OFF/CLEAR**.

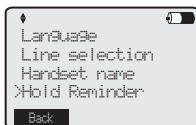

Handset setup

Speed dial

The handset has 10 speed dial locations where you can store the phone numbers you wish to dial using two key presses. You can store up to 32 digits in each location.

Enter, edit or delete a speed dial number

1. When the handset is idle, press **MENU/ENTER**.
2. Press **▲DIR** or **CID▼** to scroll to **Speed dial setup**. Press **MENU/ENTER**.
3. Press **▲DIR** or **CID▼** to choose the desired speed dial location, then press **MENU/ENTER**.
4. Use the dial pad to enter or edit the telephone number up to 32 digits. If you want to delete the entry, erase all the digits.
 - Press **◀** or **▶** to move the cursor to the left or right.
 - Press **☎ OFF/CLEAR** to backspace and delete digits.
 - Press and hold **☎ OFF/CLEAR** to delete all digits.
5. Press **MENU/ENTER** to save the setting and return to the previous menu. There is a confirmation tone. To exit without making changes, press **☎ OFF/CLEAR**.

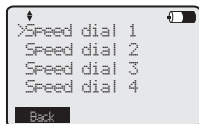
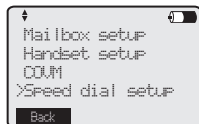

NOTES:

1. See page 24 for instructions on calling a speed dial number.
2. The memory locations for speed dial and the directory are not the same, so setting up speed dial numbers does not decrease your directory storage space.

Customer support





You can use this feature to view the AT&T website address.

1. When the handset is idle, press **MENU/ENTER**.
2. Press **▲DIR** or **CID▼** to scroll to **Customer support**. Press **MENU/ENTER**.
3. To exit, press **☎ OFF/CLEAR**.

Handset setup

Screen icons, indicator tones and lights

Screen icons

	On when line 1, line 2, line 3, or line 4 is in use. Flashes when line 1, line 2, line 3, or line 4 is put on hold.
	Handset battery status (animated display).
	Ringer off - the handset ringer is off.
	Message - new message in the handset mailbox.
-MUTE	Microphone is muted.
-PRIV	Call privacy is on.
COVM LX	There are new voicemail messages from the telephone service provider. (X is the telephone line number)
LineX	The line is in use. (X is the telephone line number)

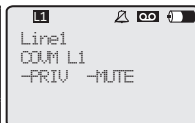

Indicator tones

Four quick beeps	Low battery warning.
One short beep	The Hold reminder is active; a call has been on hold for more than three minutes.
Error tone (a triple-beep)	<ul style="list-style-type: none"> You have reached the maximum or minimum of a setting. The directory or call log is empty.
Confirmation tone	Command completed successfully.

Lights

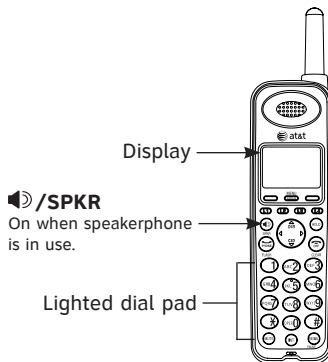

Mailbox setup

Handset mailbox overview

Each handset has its own mailbox which is different from the general mailbox on the base. If you turn on the auto attendant on the base and fast answer mode on the handset, the caller is able to leave a message on the handset mailbox **after two rings**. If you do not turn on the fast answer mode on the handset, the answering system picks up the call after five rings and allows the caller to leave a message on the handset mailbox, call another extension, or call the operator.

Fast answer mode on or off

You can set the number of times your extension rings before the auto attendant asks the caller to leave you a message or choose another extension. The number of rings can be 2 (On) or 5 (Off). The default is 5 rings.

1. When the handset is idle, press the **M.box** softkey.
2. Press **▲DIR** or **CID▼** to scroll to **Fast answer mode**. Press **MENU/ENTER**.
3. Press **▲DIR** or **CID▼** to select **On** or **Off**.
4. Press **MENU/ENTER** to save the setting and return to the previous menu. There is a confirmation tone. To exit without making changes, press **OFF/CLEAR**.

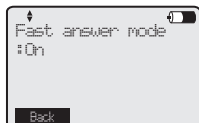
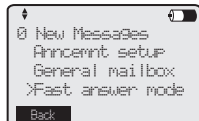

Set access code (remote access code) and mailbox security

You can enter a four-digit number (**0000-9999**) to allow remote access to your handset mailbox from any touch-tone telephone. Each handset has a different access code. Unless you change it, the access code is in numerical order for each handset (**0001** for handset 1, **0002** for handset 2 and so on). To change the access code, you must choose a four-digit number that is not used by any other registered handset or base (**0000** by default).

This access code is also used for **Mailbox security**. If you enable **Mailbox security**, each time you access the handset mailbox, you must enter the access code. If you use this code for the remote access purpose only, disable **Mailbox security**.

Mailbox setup

1. When the handset is idle, press **MENU/ENTER**.
2. Press **▲DIR** or **CID▼** to scroll to **Mailbox setup**.
3. Press **MENU/ENTER** twice to select **Set access code**.
4. Use the dial pad to enter a four-digit number. Press **OFF/CLEAR** to backspace and delete a digit.
5. Press the **Next** softkey or **MENU/ENTER** to save the password and to select **Mailbox security**.
6. Press **▲DIR** or **CID▼** to select **On** or **Off**.
7. Press **MENU/ENTER** to save the setting and return to the previous menu. There is a confirmation tone. To exit without making changes, press **OFF/CLEAR**.



NOTES:

1. The access code must have four digits.
2. You will hear an error tone and the screen displays **Please enter another** if you enter an access code that is already assigned.

Notify alert

Use this feature to receive notification calls to any phone number you set (such as a cellular phone or paging device) after a new message has been recorded to the handset mailbox. To receive notification calls, you must save the number you wish to be notified at to the handset, and then set the system to call this number after it finishes recording a message.

If the number called has caller ID service, there will be an indication of the notification call. When you receive a notification call, you hear about 15 seconds of silence; then the call is ended. There is no message sent and the call is only made once. If the call is not picked up within three rings, the handset cancels the call. You may not receive the call if the number you set is busy, not available or off during the call.

Mailbox setup

1. When the handset is idle, press **MENU/ENTER**.
2. Press **▲DIR** or **CID▼** to scroll to **Mailbox setup**. Press **MENU/ENTER**.
3. Press **▲DIR** or **CID▼** to scroll to **Notify alert**. Press **MENU/ENTER**.



Set alert number:

1. Press **MENU/ENTER** to select **Alert call #**.
2. Use the dial pad to enter the telephone number (up to 32 digits) you want to receive the notify alert.
 - Press **◀** or **▶** to move the cursor to the left or right.
 - Press **↵ OFF/CLEAR** to backspace and delete characters.
 - Press and hold **↵ OFF/CLEAR** to delete all characters.
3. Press **MENU/ENTER** to save the setting and return to the previous menu. There is a confirmation tone. To exit without making changes, press **↵ OFF/CLEAR**.

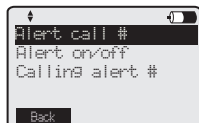

Turn alert on or off:

1. Press **▲DIR** or **CID▼** to scroll to **Alert on/off**. Press **MENU/ENTER**.
2. Press **▲DIR** or **CID▼** to select **On** or **Off**.
3. Press **MENU/ENTER** to save the setting and return to the previous menu. There is a confirmation tone. To exit without making changes, press **↵ OFF/CLEAR**.

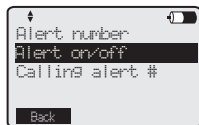

Call alert confirmation:

You can confirm whether the system can successfully call the alert number that you entered.

1. Press **▲DIR** or **CID▼** to scroll to **Calling alert #**. Press **MENU/ENTER**.
2. The screen displays **Press PHONE or SPKR to confirm alert call**.
3. Press **☎ PHONE/FLASH** or **🔊/SPKR**. The ringing of the designated phone confirms that the setup of the **Alert number** is correct.
4. After confirming that the call went to the telephone number you specified, press **↵ OFF/CLEAR** to end the test. The idle screen appears.

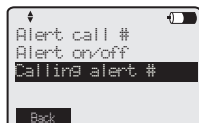

NOTE: If you try to set **Alert on/off** before you enter the **Alert call #**, **Please set alert #** appears on the screen.

Mailbox setup

Announcement setup

The announcement is the greeting callers hear when calls are answered by the handset mailbox.

The handset has the default announcement *“Hello, please leave a message after the tone.”* You can use this announcement, or replace it with your own recording.

Your announcement can be up to two minutes.

Play the current personal announcement:

1. When the handset is idle, press the **M.box** softkey.
2. Press **▲DIR** or **CID▼** to select **Annncemnt setup**. Press **MENU/ENTER** and the current announcement plays.
3. Press **MENU/ENTER** or the **OK** softkey when finished.

Record a new personal announcement:

1. When the handset is idle, press the **M.box** softkey.
2. Press **▲DIR** or **CID▼** to scroll to **Annncemnt setup**. Press **MENU/ENTER** to play current announcement.
3. Press the **Change** softkey, and then press the **Start** softkey. The system announces, *“Record after the tone. Press Stop when you are done.”*
4. Press the **Stop** softkey when finished. The recorded announcement plays.
5. Press the **OK** softkey to use the new recorded announcement.

-OR-

Press the **Change** softkey to record the announcement again.



Handset basic operation

Making a call

To make a call:

1. Press  **PHONE/FLASH** or  **/SPKR**.

-OR-

To override automatic line selection, press the **L 1-L 4** key for the desired line.

2. Enter the telephone number. The screen displays the elapsed time as you talk (in hours, minutes and seconds).

Elapsed time

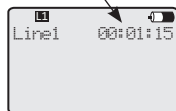



To end a call:

Press  **OFF/CLEAR**.



NOTE: Pressing  **PHONE/FLASH** to access services from your telephone service provider does not affect the elapsed time.

On hook dialing (predialing)

1. Enter the telephone number. Press  **OFF/CLEAR** to make corrections when entering the telephone number.
2. Press  **PHONE/FLASH** or  **/SPKR** to dial.

-OR-



Press the **L 1-L 4** key for the desired line.

Using the speakerphone

During a call, press  **/SPKR** to switch between handsfree speakerphone and normal handset use. Press  **OFF/CLEAR** to hang up.

Handset basic operation

Calling a speed dial number

1. Press and hold a dial pad key (**1-0**) to display the speed dial number.
2. Press  **PHONE/FLASH** or  **SPKR**.

-OR-

To override automatic line selection, press the **L 1-L 4** key for the desired line.



NOTE: If you press and hold a dial pad key that does not have a speed dial number assigned, the screen displays **No Number**.

Answering a call

- Press  **PHONE/FLASH** or  **SPKR**.

-OR-

- To override automatic line selection, press the **L 1-L 4** key for the desired line.

Ringer volume

You can set the ringer volume level (1-3), or turn the ringer off. When the ringer is off,  appears on the handset screen.

1. When the handset is idle, press **MENU/ENTER**.
2. Press **▲DIR** or **CID▼** to scroll to **Ringer setting**.
3. Press **MENU/ENTER** twice to select **Ringer volume**.
4. Press **▲DIR** or **CID▼** to adjust the ringer volume.
5. Press **MENU/ENTER** to save the setting and return to the previous menu. There is a confirmation tone. To exit without making changes, press  **OFF/CLEAR**.



NOTE: The ringer volume also determines the ringer volume for intercom calls (page 35). If the handset ringer volume is set to off, that handset is silenced for all incoming calls.

Handset basic operation

Temporary ringer silencing

Press  **OFF/CLEAR** or **MUTE** while the handset is ringing to silence the ringer temporarily on that handset only. This turns off the ringer without disconnecting the call. The next incoming call rings normally at the preset volume.



NOTE: Each handset rings when there is an incoming call unless the ringer volume is turned off on that handset.

Auto off

A call ends automatically when you put the handset in the charger.

Handset basic operation

Last number redialing

The last 10 phone numbers dialed (up to 32 digits) are stored in handset memory.

To view the 10 most recently dialed numbers:

1. Press **REDIAL/PAUSE** to enter the redial list and display the most recently called number.
2. Press **▲DIR**, or **CID▼**, or **REDIAL/PAUSE** repeatedly to view other recently called numbers.
3. Press **☰ OFF/CLEAR** to exit the redial list.

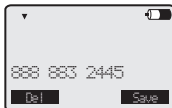

To redial a number:

- To dial the displayed number, press **☰ PHONE/FLASH**, **🔊/SPKR**, or the **L 1-L 4** key for the desired line.

-OR-

- You can call the most recently called number by pressing **☰ PHONE/FLASH**, **🔊/SPKR**, or the **L 1-L 4** key for the desired line, and then pressing **REDIAL/PAUSE**.

To edit a number:

- While the desired number displays, press **MENU/ENTER** to enter editing mode.
- Press **◀** or **▶** to move the cursor to the left or right. Press **☰ OFF/CLEAR** to backspace and delete characters.

To delete a number:

While the screen displays the desired number, press the **Del** softkey to delete the number from the redial memory.

To save an entry into the directory:

While the desired number displays, press the **Save** softkey to display the edit screen of the directory. See Steps 3-6 of **Create and store a directory entry** on pages 42-43 for details.

Options while on calls

Volume control

While on a call, press **VOLUME ▲ ▼** to increase or decrease the listening volume.

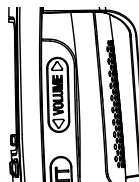

NOTES:

1. Handset and speakerphone volume settings are independent.
2. When the volume reaches the minimum or maximum setting, you hear an error tone.



Call waiting

If you subscribe to call waiting service with your telephone service provider, you hear a beep if someone calls while you are already on a call.

- Press  **PHONE/FLASH** to put your current call on hold and take the new call.
- Press  **PHONE/FLASH** at any time to switch back and forth between calls.

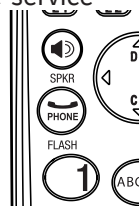

NOTES:

1. If you miss a call waiting call, the caller ID of the missed call displays for 15 seconds after the first call.
2. For more information on caller ID with call waiting, see page 48.

Call privacy

To ensure call privacy, this telephone allows only one set at a time to use a line. You can also block all system handsets from joining a phone conversation (see page 31 for instructions for joining calls).

To enable call privacy:

During the call, press **MENU/ENTER** twice to select **Privacy ON**. The screen displays **-PRIV**. No extensions can join the call. If another extension tries to access the line you are using, their screen shows **Privacy**. Call privacy is automatically canceled when you end the call.



Options while on calls

To cancel call privacy:

During the call, press **MENU/ENTER** twice to select **Privacy OFF**. Other extensions can now join the call by pressing the appropriate line key.



NOTES:

1. You cannot set call privacy during intercom or conference calls.
2. Call privacy applies only to the system telephones. It does not affect non-system phones using the same line(s).

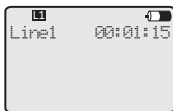

Recording a call

You can record two-way phone conversations during a call. The recording is treated the same as memos and is marked as a new message in the mailbox. However, there is no new message indication shown on the screen. You cannot record a conference call or an intercom call and you cannot use another line while you are recording the phone conversation.

To record a call:

1. While on a call, press **MENU/ENTER**.
 2. Press **▲DIR** or **CID▼** to scroll to **Record call on**. Press **MENU/ENTER**.
 3. The recording starts and the system activates call privacy. The screen displays **-PRIV** and **-REC**.
 4. To stop recording and continue the call, press **MENU/ENTER** twice. The system saves the conversation into the handset mailbox.
- OR-**

The recording ends when you disconnect the call.

Options while on calls

While recording a call:

The other party hears a short beep when the recording begins and once each minute during the recording. To ensure compliance with state and federal regulations regarding the recording of a telephone call, you should start the recording process by informing the caller that you are recording the call.

i **NOTE:** Calls that you record use the same memory as the answering system. Recording long conversations uses up space available for recording normal messages. Please see **Remaining space** in the SynJ SB67118/SB67138 telephone base manual.

Play back a recorded call:

Play memos or two-way phone conversations the same way as messages are played. See **Message playback** on page 59.

Mute

Use the mute function during a telephone conversation to silence the microphone. You can hear the caller, but the caller does not hear you.

To mute a call:

- Press **MUTE**. When mute is on, the handset screen flashes **-MUTE**.

To end mute a call:

- Press **MUTE** again and resume speaking.

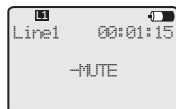
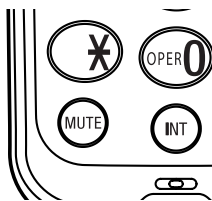

Options while on calls

Hold

Use this feature to hold one line while accessing another, or as part of the conference and call transfer features.

While on a call, press and release **HOLD**. The **L 1-L 4** indicator for the line on hold flashes slowly on the screen. After the call has been on hold for more than three minutes, you will hear a beep every 30 seconds. (To turn off the reminder beep, see page 16.)

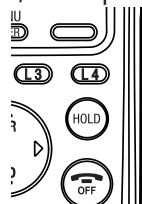

If you are using the speakerphone, the speakerphone turns off automatically when you press **HOLD**.

To release the hold, press the **L 1-L 4** key of the call on hold.

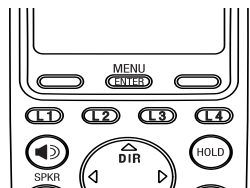

NOTES:

1. A call on hold after 10 minutes is automatically forwarded to the auto attendant, even if the auto attendant is not on. To keep a call on hold longer than 10 minutes, release the held call within 10 minutes and then place the call on hold again.
2. You cannot put an intercom call on hold.

Switching between lines

Use this feature to switch between lines during an outside call:

1. Press the **L 1-L 4** key of another line to make or answer another call. The current call is put on hold automatically.
2. To return to the first call, press the original **L 1-L 4** key. The second line is put on hold automatically.

Options while on calls

Join a call in progress

You can join in an ongoing call on any line that does not have call privacy set (see page 27 for information on call privacy). The line icon appears on the screen when the line is in use.

- Press and hold the appropriate **L 1-L 4** key on the handset to join in the call, which becomes a three-way conference (see page 32).



NOTES:

1. When you try to join an ongoing call on a line with call privacy on, the screen displays **Privacy** and you hear four quick beep tones.
2. A maximum of one extension can join in an ongoing call.

Chain dialing

While you are on a call, you can initiate a dialing sequence from the numbers in the directory.

Chain dialing can be useful if you wish to access other numbers (such as bank account numbers or access codes) from the directory.

To access the directory while on a call:

1. Press **▲DIR** to enter the directory.
2. Press **▲DIR** or **CID▼** to scroll to the desired number.
3. Press **MENU/ENTER** to dial the number shown.

To exit without making changes, press the **Back** softkey and continue with the conversation.



NOTE: You cannot edit a directory entry while on a call. For more details about the directory, see page 41.

Options while on calls

Three-way conference calls

You can set up a three-party call by using two lines at the same time. You can also join an intercom call with a call on an outside line. The outside line call must be established first because an intercom call cannot be placed on hold.

1. Make or answer an outside call.
2. Press **HOLD**. Then call someone using another line, answer a call, or intercom someone (see page 35).

-OR-

Call someone or answer a call using another line, or intercom someone. The first call is put on hold automatically.

3. Press the **Conf** softkey any time to begin the three-party conference.

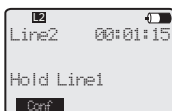
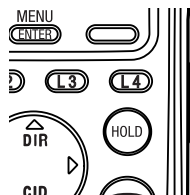

To talk privately with one external party:

1. Press **HOLD** to place both lines on hold.
2. Press a **L 1-L 4** key to talk privately with the person on that line.
3. Press the **Conf** softkey to resume the conference call.

To talk privately with one internal party:

1. Press **HOLD** to talk privately with the person on the other extension. The external line is automatically placed on hold.
2. Press the **Conf** softkey to resume the conference call.

To drop one line:

Press the **L 1-L 4** key to activate the line you want to drop and press **OFF/CLEAR**. The other external line is put on hold automatically.

Options while on calls

To drop an intercom call:

Press the **L 1-L 4** key to activate the external call and the intercom call drops automatically.

To end a conference call:

Press  **OFF/CLEAR** or hang up. The call does not end until all extensions hang up.



NOTES:

1. If an internal party hangs up, the ongoing call becomes a two-way conversation.
2. You cannot make any conference calls if all four telephone lines are in use.
3. If you are experiencing difficulty in using the conference features on this telephone, please consider using AT&T's complete line of teleconference services to find a solution that best meets your needs. AT&T TeleConference Services reduces travel time and expenses while increasing productivity wherever people are located, enabling you to host truly virtual meetings and share important information in real time. To sign up for AT&T TeleConference Services, go to:
www.att.com/orderconference for details.

COVM

COVM (central office voicemail)

If you subscribe to voicemail service with your telephone service provider, and you want the handset to indicate when you have new voicemail, turn the **COVM** indicator on. When a phone line receives any new voicemail messages, **COVM LX** (X is the telephone line number) displays on the screen.

If you do not subscribe to voicemail service, turn off the **COVM** feature.

1. When the handset is idle, press **MENU/ENTER**.
2. Press **▲DIR** or **CID▼** to scroll to **COVM**.
3. Press **MENU/ENTER** twice to select **COVM on/off**.
4. Press **▲DIR** or **CID▼** to select **On** or **Off**.
5. Press **MENU/ENTER** to save the setting and return to the previous menu. There is a confirmation tone. To exit without making changes, press **OFF/CLEAR**.



NOTE: If there are messages waiting from the telephone service provider when you turn on this feature, the screen displays the **COVM** indicator.

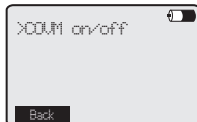

Intercom

You can use the intercom feature for conversations between the telephone base and an accessory device, or between two accessory devices. When the system is on one or more external calls, accessory devices can make intercom calls with each other. If you have a cordless headset, it can only receive intercom calls.

Each device that is registered to the telephone base is assigned an extension. Extension numbers are assigned in sequential order (0-9) as they are added.

Use the handset number to initiate intercom and transfer calls between handsets. Use * (star key) to initiate intercom and transfer calls between the handset and the telephone base.

When you intercom or transfer to the 10th handset or the cordless headset, you must press 0.

Make an intercom call

1. When the handset is idle, press **INT**.
2. Press ▲**DIR** or **CID**▼ to scroll to the desired extension number. Press **MENU/ENTER**.

-OR-



Press the desired extension number, * (star key) for the base, or # (pound key) for all.

Your handset screen shows **Calling X:Handset X**, **Calling X:Deskset X**, **Calling *:Base**, or **Calling All**.

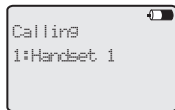
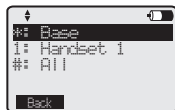
3. Answer an intercom call just as you would answer a normal call, or press **INT**. Both extensions now show **Intercom**.
4. End an intercom call just as you would end a normal call.



NOTES:

1. Before the intercom call is answered, you can cancel the intercom call by pressing  **OFF/CLEAR** on the calling handset.
2. The intercom call automatically cancels if the call is unanswered after one minute.
3. Pressing  **OFF/CLEAR** or **MUTE** temporarily silences the intercom ringer.
4. When you choose **All** in the menu, all the devices ring. The intercom call is established with the first one who answered the call.
5. If a line is in use, pressing **INT** places the line on hold and activates the intercom.

Intercom

Answer an incoming call during an intercom call

If you receive an incoming outside call during an intercom call, you will hear two beeps. To answer the call, press the **L 1-L 4** key. The intercom call ends automatically.

 **NOTE:** You cannot use  **PHONE/FLASH** or  **SPKR** to answer the incoming call.

Answer an intercom call

When you receive an intercom call, you hear a ringing tone and your screen displays **Call X:Handset X** (**X** represents the extension number [1-0]; **Handset X** represents the default handset name), **Calling X: Deskset X** (**X** represents the extension number [1-0], **Deskset X** represents the deskset name), or **Call *:Base**. Answer an intercom call just as you would answer a normal call.

End an intercom call

End an intercom just as you would end a normal call.

Call transfer using intercom

You can transfer a call to any other system telephone.

1. During a call, press **INT**.
2. Press **▲DIR** or **CID▼** to scroll to the desired extension number. Press **MENU/ENTER**.



-OR-

Press the desired extension number, ***** (star key) for the base, or **#** (pound key) for all.

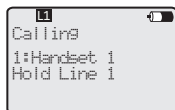

The outside call is put on hold and your handset screen shows **Calling X:Handset X**, **Calling X:Deskset X**, **Calling *:Base**, or **Calling All**.

3. The other handset or base rings and its screen shows **Call X:Handset X**.
4. Answer an intercom call just as you would answer a normal call, or press **INT**. The outside call is still on hold and both handsets now show **Intercom**. You can now have a private conversation between the system devices.



i NOTE: Before the intercom call is answered, you can cancel the call transfer and return to the external call by pressing the **L 1-L 4** key on your handset.

5. From this intercom call, you have the following options:
 - You can let the other handset join you on the outside call in a three-way conversation. Press the **Conf** softkey on your handset.
 - You can release the outside call to the other extension before the intercom call is answered (blind transfer). Press **OFF/CLEAR**, or place your handset back in the charger. The other handset automatically connects to the outside call.

i NOTE: If a transferred call is not answered after 30 seconds, the transfer is canceled. The external call returns to the originating handset and is on hold. If the hold reminder is turned on, the handset beeps every 30 seconds. Press the **L 1-L 4** key to answer the external call.

- You can return to the outside call. Press the **L 1-L 4** key on your handset.
- The other person can end the intercom call by pressing **OFF/CLEAR**, or by placing the other handset back in the charger. Press the line key on the original extension to resume the outside call.

Push to talk (PTT) intercom

You can directly broadcast your voice to the speakerphone of any extension. The extension you called can respond by pressing the **INT** key to begin two-way communication. Up to five pairs of PTT calls can be maintained at a time.

PTT call to a single device

1. When the handset is idle, press **PTT**.
2. Press **▲DIR** or **CID▼** to choose the desired handset or base.
3. Press and hold **PTT** until your handset screen shows **PTT to: X:Handset X Release PTT key to stop** (X represents the extension number [1-0]; **Handset X** represents the default handset name), **PTT to: X:Deskset X Release PTT key to stop** (X represents the extension number [1-0], **Deskset X** represents the deskset name), or **PTT to: *:Base Release PTT key to stop**. When the connection is made, both the caller and the destination party hear two beeps.
4. Speak into the speakerphone while continuing to hold down the **PTT** key. Your voice is broadcast to the desired extension.
5. Release the **PTT** key after speaking. There is a three-second PTT wait state with **-MUTE** slowly flashing on the screen. During the PTT wait state, if necessary, you can press and hold the PTT key to continue speaking into the speakerphone.
6. The destination party can now respond (see **Answer a PTT call** on page 39).

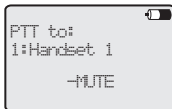
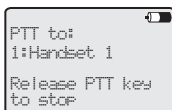
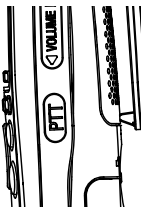

i **NOTE:** If the called handset or telephone base is on an intercom or outside call, your handset sounds a busy signal and displays **Busy**.

Push to talk (PTT) intercom

PTT call to all devices

1. When the handset is idle,

Press and hold **PTT** on the side of your handset until your handset screen shows **PTT to: All**.

-OR-

Press **PTT**. Press **▲DIR** or **CID▼** to choose #: **All**.

Press and hold **PTT** until your handset screen shows **PTT to: All**.

When the connection is made, both the caller and the destination parties hear two beeps. The speakerphones on all other extensions automatically activate.

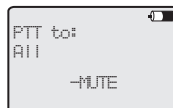
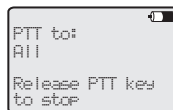

2. Speak into the speakerphone. Your voice is broadcast to all extensions.
3. Release **PTT** after speaking. There is a three-second PTT wait state with **-MUTE** slowly flashing on the screen. During the PTT wait state, if necessary, you can press and hold the PTT key to continue speaking into the speakerphone.
4. Any extension can reply (see **Answer a PTT call** below).

Answer a PTT call

1. When you hear two beeps, the screen displays **PTT from: X:Handset X** (X represents the extension number [1-0]; **Handset X** represents the default handset name), **PTT from: X:Deskset X** (X represents the extension number [1-0], **Deskset X** represents the handset name). or **PTT from: *:Base**.

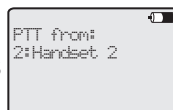

2. Press **INT** to convert the call into a normal intercom call with that extension.

-OR-

Respond with a new PTT call. Wait for the end of the three-second PTT wait state (the screen changes to idle mode). To respond with a handset, see **PTT call to a single device** or **PTT call to all devices** on pages 38-39. To respond with the telephone base, see **Answer a PTT call** in the SynJ SB67118/SB67138 user's manual.

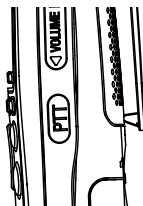
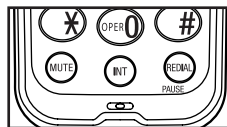

Push to talk (PTT) intercom



NOTE: If the PTT call is sent to all handsets and base, the intercom call is established with the first one who presses **INT**.

Convert PTT call to intercom call

You can convert the PTT call to a two-way intercom call on the called handset.

1. Press **INT** on the called extension to convert the call to a two-way intercom call.
2. Optionally, press  **OFF/CLEAR** to end the intercom.

End PTT call

Press  **OFF/CLEAR** to end the incoming PTT call.

About the directory

Use the directory to store names and phone numbers. Directory entries are not shared with the telephone base or other extensions. Each handset has its own directory.

Capacity

The directory in each handset is independent from all other handsets. In other words, changes made to the directory on any handset apply only to that particular handset.

Each directory can store up to 100 entries, with a maximum of 16 alphanumeric characters (including spaces) for names and 32 digits for telephone numbers. Directory entries are sorted in alphabetical order.

If all memory locations are in use, the screen displays **Memory is full**. You cannot store a new number until an existing number is deleted. If you try to view the directory entries when there are no entries, the screen displays **Directory empty**.

Exit the directory

On a handset, press **OFF/CLEAR** to return to idle mode.

If you pause for too long while creating or reviewing an entry, the procedure times out and you must begin again.

Create directory entries

Create and store a directory entry

Use the following steps to store a name and number in the directory.

1. When the handset is idle:

- Press **MENU/ENTER** twice to select **Directory**.
- OR-
- Press **▲DIR** to enter the directory.



2. Press the **Add** softkey to add an entry.

3. Enter or change the telephone number (up to 32 digits) using the dial pad when prompted.

- Press **◀** or **▶** to move the cursor to the left or right.
- Press **OFF/CLEAR** on the handset to backspace and delete characters.
- Press and hold **OFF/CLEAR** on the handset to delete all characters.
- Press **REDIAL/PAUSE** to enter a three-and-a-half second dialing pause (see page 43).
- Press the **Flash** softkey to enter a flash (see page 44).
- Press the **Back** softkey to return to the previous screen.

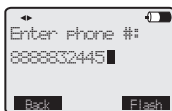

i **NOTE:** If the telephone number in the directory exceeds 16 digits, **<** appears in front of the telephone number. Press **<** to move towards the beginning of the telephone number or press **>** to move towards the end of the telephone number.



4. Press **MENU/ENTER** to save the number.

5. Enter the name when prompted.

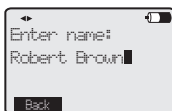
- Use the dial pad to enter a name (up to 16 characters). Each time a key is pressed, the character on that key appears. Additional key presses produce other characters on that key. See the chart on the next page.



Create directory entries

- Press ◀ or ▶ to move the cursor to the left or right.
- Press  **OFF/CLEAR** to backspace and delete characters.
- Press and hold  **OFF/CLEAR** on the handset to delete all characters.
- Press the **Back** softkey to return to the previous screen.

Number key	Characters by number of key presses								
	1	2	3	4	5	6	7	8	9
1	&	'	()	,	-	.	/	1
2	a	b	c	A	B	C	2		
3	d	e	f	D	E	F	3		
4	g	h	i	G	H	I	4		
5	j	k	l	J	K	L	5		
6	m	n	o	M	N	O	6		
7	p	q	r	s	P	Q	R	S	7
8	t	u	v	T	U	V	8		
9	w	x	y	z	W	X	Y	Z	9
0	space	0							
*	*								
#	#								

6. Press **MENU/ENTER** to save the setting and return to the previous menu. There is a confirmation tone. To exit without making changes, press  **OFF/CLEAR**.

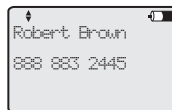

Store a pause in a directory number

Use this feature to include a pause in a number stored in the directory. You might need a pause in a directory number to enable access to automated phone systems.

- When you wish to enter a pause in the dialing sequence, press **REDIAL/PAUSE** to store a three-and-a-half second pause. A **P** appears in the telephone number. Each pause counts as one digit. If you want to save the number in the directory, press **MENU/ENTER**.

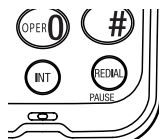

Create directory entries

Store a flash in a directory number

Use this feature to store the flash needed to access certain custom-calling services in a directory number.

- When you wish to enter a flash in the dialing sequence, press the **Flash** softkey. An **F** appears in the telephone number. Each flash counts as one digit. If you want to save the number in the directory, press **MENU/ENTER**.



Review directory

Review directory entries

1. When the handset is idle,

Press **MENU/ENTER** twice to select **Directory**.

-OR-

Press **▲DIR** to enter the directory.

If there are no directory entries, the screen displays **Directory empty**.

2. Press **▲DIR** or **CID▼** to browse through the directory. Entries appear alphabetically by the first letter in the name.

Search directory

Search by name

Follow the steps below to search for directory entries on the handset.

1. When the handset is idle, press **MENU/ENTER** twice to select **Directory**.

-OR-

Press **▲DIR** to enter the directory.

2. Press **▲DIR** or **CID▼** to browse through the directory.

3. When a name entry appears, press the dial pad keys (**2-9**) to start a name search.

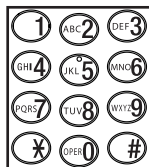

The directory shows the first name beginning with the first letter associated with the dial pad key, if there is an entry in the directory beginning with that letter. If there is no entry matching the letter you press, it remains in the current entry.

The handset displays the first name associated with that letter only. Press **▲DIR** or **CID▼** to scroll through the entries beginning with this character. The names are sorted in alphabetical order.

4. To see other names starting with the letters on the same dial pad key, keep pressing the key. The names are sorted in alphabetical order.



For example, if you have the names **Jennifer**, **Jessie**, **Kevin** and **Linda** in your directory:

- If you press **5 (JKL)** once, you see **Jennifer**.
- If you press **5 (JKL)** twice, you see **Kevin**.
- If you press **5 (JKL)** three times, you see **Linda**.
- If you press **5 (JKL)** four times, you see **Jennifer**.
- To view **Jessie**, press **CID▼** while **Jennifer** is displayed.

Dial, delete or edit entries

You can dial, delete or edit a directory entry (name and number) when it is shown on the handset screen. See **Review directory entries** on page 45 for instruction on how to display an entry.

Display dial

When a number is displayed on the screen, you can dial the number by pressing  **PHONE/FLASH**,  **SPKR**, or the **L 1-L 4** key for the desired line.

Delete an entry

When a directory entry is displayed, press the **Del** softkey to delete the displayed entry from the directory. You cannot retrieve a deleted entry.

Delete all entries

1. When the handset is idle, press **MENU/ENTER** twice to select **Directory**.

-OR-

Press **▲DIR** to enter directory.

2. Press the **Del All** softkey and the screen displays **Delete entire directory?** Press the **YES** softkey to confirm or press the **NO** softkey to return to the previous screen.



NOTE: You cannot retrieve deleted entries.

Edit an entry

1. When a directory entry appears, press the **Edit** softkey.

2. Follow Steps 3 to 6 on pages 42-43.



NOTE: If the telephone number in the directory exceeds 16 digits, **<** appears in front of the telephone number in the editing screen. Press **<** to move towards the beginning of the telephone number or press **>** to move towards the end of the telephone number.

About caller ID (call log)

This telephone supports caller ID services that most telephone service providers offer. Caller ID allows you to see the name, number, date and time of calls. Depending on your service subscription, you might see the caller's number, or the caller's name and number from the telephone service provider after the first or second ring. Caller ID information might not be available for every incoming call. Callers may intentionally block their names and/or telephone numbers.

This product can provide information only if both you and the caller are in areas offering caller ID service and if both telephone service providers use compatible equipment.



Information about caller ID with call waiting

Caller ID with call waiting lets you see the name and telephone number of the caller before answering the telephone, and while on another call.

There are fees for caller ID services. In addition, this service might be called different names (such as caller ID with visual call waiting) by different telephone service providers and might not be available in all areas.

It might be necessary to change your telephone service to use this feature. Contact your telephone service provider if:

- You have both caller ID and call waiting, but as separate services (you might need to combine these services).
- You have only caller ID service, or only call waiting service.
- You don't subscribe to caller ID or call waiting services.

NOTES:

1. You can use this telephone with regular caller ID service, or you can use this telephone's other features without subscribing to either caller ID or combined caller ID with call waiting service.
2. The format of telephone numbers displayed depends on the home and local area codes you set on the base.

Caller ID history

How caller ID history (call log) works

The handset stores caller ID information for the last 50 incoming calls. Entries are stored in reverse chronological order. The phone deletes the oldest entry when the log is full to make room for new calls.

Each extension has an independent caller ID history. Deleting the caller ID history on any one extension does not affect the caller ID history on other extensions.

If you answer a call before the information appears on the screen, it does not show in the caller ID history.

Review the caller ID history to determine who called, return the call, or copy the caller's name and number into your directory.

XX Missed call(s) appears if there are new call log entries (including new or missed calls). **Call log empty** appears if there are no records in the call log.



The time and date of the call and the caller's name and telephone number are included in the display.

Caller ID information appears on the screen as the phone rings, or until the caller hangs up, or until the call has been answered at another extension, or until the call ends.

If you subscribe to caller ID service, this phone automatically resets the time and date each time new call information is received.

Handset screen display

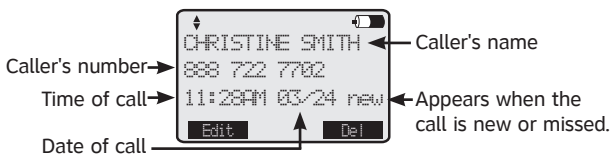

Caller ID history



NOTES:

1. Caller ID information might not be available for every incoming call. The callers might intentionally block their names and/or telephone numbers.
2. Each entry can store up to 32 digits for the telephone number and 16 characters for the name. If the telephone number has more than 16 but fewer than or equal to 24 digits, only the last 16 digits appear. If the telephone number has more than 24 digits, only the 9th to 24th digits (16 digits) appear. In order to view the entire number, you must first save the entry to the directory (see page 54). For instructions on viewing the digits, see the note on page 47. If the telephone number has more than 32 digits, it is not saved or shown in the call log.

Caller ID operation

Memory match

If the incoming telephone number is an exact match with a telephone number in your directory, the name that appears on the screen matches the corresponding name in your directory.

For example, if Christine Smith calls, her name appears as **Chris** if this is how you entered it into your directory.



NOTE: The number you see on your caller ID is in the format from the telephone service provider. It usually delivers 10-digit telephone numbers (area code plus telephone number). The telephone system ignores the area code when searching for a match and displays the name of the first corresponding number from the directory.

Missed (new) calls indicator

When a handset is idle and has new or missed calls, its screen shows **XX Missed call(s)** and the **CID** softkey flashes.

All new or missed entries are identified as missed calls. Each time you review a call log entry with the icon **new**, the number of missed calls decreases by one. When all the entries in the caller ID history have been reviewed, the system removes the missed calls alert from the display.



Caller ID operation

Review caller ID history

1. When the handset is idle, press **CID**▼ or the **CID** softkey.

-OR-

When the handset is idle, press **MENU/ENTER**. Press ▲**DIR** or **CID**▼ to scroll to **Call log**, then press **MENU/ENTER**.

2. Press ▲**DIR** or **CID**▼ to scroll through the list to review the caller ID history in chronological or reverse chronological order starting with the most recent call first.

3. To exit without making changes, press **OFF/CLEAR**.

Make a call log entry ready to dial

Although the incoming call log entries have 10 digits (the area code plus the seven-digit number), in some areas, you might need to dial only the seven digits, 1 plus the seven digits, or 1 plus the area code plus the seven digits. You can change and store the number of digits that you dial in the call log.

While reviewing the call log, press **#** repeatedly on a cordless handset to show different dialing options for local and long distance numbers before dialing or saving the telephone number in the directory.

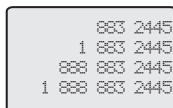

Press **#**

Caller ID operation

Dial a call log entry

1. When in the call log, press ▲**DIR** or **CID**▼ to browse to the entry you wish to dial.
2. Press ☎ **PHONE/FLASH**, 📣/SPKR, or **L 1-L 4** key to dial the entry.

Delete entries

Delete a caller ID entry:

1. When in the call log, press ▲**DIR** or **CID**▼ to browse to the number you wish to delete.
2. Press the **Del** softkey to delete the shown entry from the caller ID history.

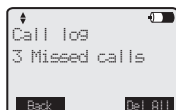

Delete all caller ID entries:

1. When in the call log, press the **Del All** softkey.
2. When the screen shows **Delete all calls?** Press the **Yes** softkey to clear the caller ID history of all entries, or press the **No** softkey to exit and leave all entries in the caller ID history intact.

To exit without making changes, press ☎ **OFF/CLEAR**.

Caller ID operation

Save a call log entry to the directory

1. When in the call log, press **▲DIR** or **CID▼** to browse to the entry you wish to save.
2. Press the **Edit** softkey to select the displayed entry. **Enter phone #:** displays.
3. Use the dialing keys to edit the number.
 - Press **OFF/CLEAR** on the handset to backspace and delete characters.
 - Press and hold **OFF/CLEAR** on the handset to delete all characters.
 - Press **◀** or **▶** to move the cursor to the left or right.
 - Press **REDIAL/PAUSE** to enter a three-and-a-half second dialing pause (see page 43).
 - Press the **Flash** softkey to enter a flash (see page 44).
4. Press **MENU/ENTER** to move to the name. **Enter name:** displays.
 - Use the dial pad keys to add characters (see page 43).
 - Press **OFF/CLEAR** on the handset to backspace and delete characters.
 - Press and hold **OFF/CLEAR** on the handset to delete all characters.
5. Press **MENU/ENTER** to save the new directory entry. There is a confirmation tone. To exit without making changes, press **OFF/CLEAR**.



NOTE: You will need to change how a caller ID number is dialed if the entry does not appear in the correct format. Caller ID numbers might appear with an area code that might not be necessary for local calls, or without a 1 that might be necessary for long distance calls (see **Make a call log entry ready to dial** on page 52).

Reasons for missing caller ID information

There are also occasions when other information or no information shows for various reasons:

On-screen message	Reason
Private caller	The caller prefers not to show the telephone number and name.
Unknown caller	Your telephone service provider cannot determine the caller's name and telephone number. Calls from other countries may also generate this message.

Handset voicemail box (answering system)

Each handset has a private voicemail box that is different from the general mailbox on the base. The voicemail messages for each handset can be accessed from that handset or telephone base.

Answering system and voicemail

Your telephone has separate indicators for two different types of voice messages: those left on its built-in answering system and those left at your service provider's voicemail. Your telephone's built-in answering system messages and voicemail messages are separate. Each alerts you to new messages differently.

- If you turn on the **COVM** feature (see **COVM** on page 34 for more information) and the **COVM** icon displays on the handset screen, your telephone service provider is indicating that it has new voicemail for you. To listen to your voicemail, you typically dial an access number provided by your telephone service provider, followed by a security code or PIN.
- To listen to messages recorded on your digital answering system, press the **M.box** softkey on the handset.



Some service providers bundle or combine multiple services like voicemail and call waiting, so you may not be aware that you have voicemail. To check what services you have and how to access them, contact your telephone service provider.

To use your voicemail service rather than your answering system, turn off your answering system. To use your answering system rather than your voicemail service, contact your telephone service provider to deactivate your voicemail service. You can also use your telephone answering system and voicemail together by setting your built-in answering system to answer before voicemail answers as described below. To learn how to program your voicemail settings, contact your telephone service provider. Then, if you are on a call, or if the answering system is busy recording a message and you receive another call, the second caller can leave a voicemail message.

Answering system and voicemail

Set your answering system to answer calls at least two rings earlier than your voicemail is set to answer. For example, if your voicemail answers after six rings, set your answering system to answer after four rings. Some voicemail providers may program the delay before answering calls in seconds instead of rings. In this case, allow six seconds per ring when determining the appropriate setting.

Setting your system to automatically answer calls

On the base you can set each of the four lines to automatically answer incoming calls in two different ways. See the **SynJ SB67118/SB67138** manual for more information.

General mailbox:

The called line rings on every extension for each incoming call. If there is no answer, the caller is prompted to leave a message in the general mailbox, which a person at any handset can review. The general mailbox stores incoming messages, memos and recorded calls.

Auto attendant:

The called line for each incoming call flashes on every extension, but does not ring. Instead, the auto attendant answers. The caller can specify an extension or leave a general mailbox message. When the auto attendant directs a call to an extension but it is not answered, the auto attendant prompts the caller to leave a message for that extension or try another extension.

Record announcement

The announcement is the greeting callers hear when calls are answered by the handset mailbox. You can record a personal announcement up to two minutes long (see page 22).

Answering system capacity

The maximum recording time of all handsets and base is 180 minutes. The actual recording time depends on individual message characteristics. Individual messages can be up to three minutes. Messages remain available for review until you delete them.

Each recorded announcement requires system memory, so we suggest recording a brief announcement in order to leave more space for messages.

Setting your system to automatically answer calls



NOTE: You cannot record an announcement when the telephone system is out of space. You will hear a two-beep alert tone and voice prompt "Memory is full." Please refer to **Remaining space** in the SynJ SB67118/SB67138 telephone base manual.

Voice prompts

The system provides voice prompts to guide you through the setup procedures.

New message indication

When you have new messages in the handset mailbox, the screen displays **New messages**. In addition, the **M.box** softkey and the new message indicator  flash.



If the notify alert is turned on (pages 20-21), you will receive a phone call at the telephone number you chose each time a new message has been recorded.

There is no new message indication on the handset when messages are left in the general mailbox.

Turn alert on or off

1. When the handset is idle, press **MENU/ENTER**.
2. Press **▲DIR** or **CID▼** to scroll to **Mailbox setup**. Press **MENU/ENTER**.
3. Press **▲DIR** or **CID▼** to scroll to **Notify alert**. Press **MENU/ENTER**.
4. Press **▲DIR** or **CID▼** to scroll to **Alert on/off**. Press **MENU/ENTER**.
5. Press **▲DIR** or **CID▼** to select **On** or **Off**.
6. Press **MENU/ENTER** to save the setting and return to the previous menu. There is a confirmation tone. To exit without making changes, press **OFF/CLEAR**.

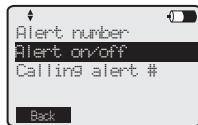

NOTE: If you try to set **Alert on/off** before you enter the **Alert call #** (see page 21), **Please set alert #** appears on the screen.

Message playback

From a handset, you can play the messages from that handset mailbox and the general mailbox.

If you have new messages, the system plays them (in chronological order) automatically when you access the mailbox.

When playback begins, the total number of messages is announced. Before each message, you hear the date and time of the recording. After the last message, you hear *"End of messages."*

Listen to new messages on a cordless handset:

- When the handset is idle, press the **M.box** softkey and the new messages play automatically.

Play all old messages on a cordless handset:

1. When the handset is idle, press the **M.box** softkey.
2. Press **MENU/ENTER** to select **Play all**.

Listen to new messages on the general mailbox:

1. When the handset is idle, press the **M.box** softkey.
2. Press **▲DIR** or **CID▼** to scroll to **General mailbox**.
3. Press **MENU/ENTER** and the new messages plays automatically.

Play all old messages on the general mailbox:

1. When the handset is idle, press the **M.box** softkey.
2. Press **▲DIR** or **CID▼** to scroll to **General mailbox**.
3. Press **MENU/ENTER** twice to select **Play all**.

When you are in the general mailbox, press **▲DIR** or **CID▼** to scroll to **Go to HS MBox** and press **MENU/ENTER** to return to the handset mailbox.

Message playback

Options during playback

When a message is playing, you can skip, repeat, or delete the message, or adjust the playback volume.

When messages are playing on the handset:

- Press **VOLUME ▲ ▼** to adjust the message playback volume.
- Press **▶** to skip to the next message.
- Press **◀** to repeat the message. After you hear "Repeat" and within five seconds, press **◀** again to hear the previous message.
- Press the **Del** softkey to delete the message.
- Press **OFF/CLEAR** to stop the playback and return to idle mode.
- Press the **Back** softkey to return to the previous screen.
- Press **SPKR** to switch between speakerphone mode and handset mode.



NOTE: If you press **◀** within five seconds of each message playback start, the previous message plays instead of repeating the current message.

Delete all old messages

You can only delete old (reviewed) messages. You cannot delete new messages until you review them. You cannot retrieve deleted messages.

Delete all old messages on the handset mailbox:

1. When the handset is idle, press the **M.box** softkey.
2. Press **▲DIR** or **CID▼** to scroll to **Delete all old**. Press **MENU/ENTER**.
3. The screen displays **Delete all old messages?** Press the **Yes** softkey to confirm or press the **No** softkey to return to the previous screen.



Message playback

Delete all old messages on the general mailbox:

1. When the handset is idle, press the **M.box** softkey.
2. Press **▲DIR** or **CID▼** to scroll to **General mailbox**. Press **MENU/ENTER**.
3. Press **▲DIR** or **CID▼** to scroll to **Delete all old**. Press **MENU/ENTER**.
4. The screen displays **Delete all old messages?** Press the **Yes** softkey to confirm or press the **No** softkey to return to the previous screen.



NOTE: If there are any new or missed messages in the handset mailbox, the new message indicator still flashes after you delete all old messages.

Recording and delivering memos

Memos are messages you record at a handset. You can save, play and delete them like incoming messages. You can record a memo as a reminder to yourself, or send a memo to other extensions using the answering system.

Record and deliver a memo to a handset mailbox:

When the handset is idle, press the **M.box** softkey. Go to Step 3 below.

Record and deliver a memo to the general mailbox:

1. When the handset is idle, press the **M.box** softkey.
2. Press **▲DIR** or **CID▼** to scroll to **General mailbox**. Press **MENU/ENTER**.
3. Press **▲DIR** or **CID▼** to scroll to **Deliver**. Press **MENU/ENTER**.
4. Press **▲DIR** or **CID▼** to choose the desired handset or base to receive the memo. Press **MENU/ENTER**.
5. Press the **Start** softkey. The system announces *“Hello! Please leave a message after the tone. Press **Stop** when you are done.”* You can record a memo for up to three minutes. The system does not save memos shorter than three seconds.
6. Speak facing the handset to record the memo.
7. Press the **Stop** softkey to stop recording. The recorded memo plays automatically.
8. Press the **OK** softkey to confirm. The system sends the memo to the extension you selected automatically.

-OR-

Press the **Change** softkey to change the memo and go back to Step 6 until you confirm the memo.



NOTE: If you record a memo when the memory is full, the screen displays **Message full**.

Remote access

You can access your handset answering system remotely by dialing your telephone number from any touch-tone telephone.

To remotely access the answering system:

1. Dial your telephone number from any touch-tone telephone.
2. When the system answers, enter the four digit remote access code of your handset (**0001** is default code for handset 1, **0002** is default code for handset 2 and so on. See page 19 to change it). The system automatically announces the number of messages (new and/or old) if there are any, and then begins to play them.
3. You can also enter the following remote commands.

Remote commands

1	<ul style="list-style-type: none"> • Press to play to all messages. • Press to record a new announcement (during announcement playback).
2	<ul style="list-style-type: none"> • Press to accept the recorded announcement (during announcement playback).
3	<ul style="list-style-type: none"> • Press to delete the current message (during playback). • Press to delete the recorded announcement (during announcement playback).
4	<ul style="list-style-type: none"> • Press to repeat the current message (during playback). • After you hear "Repeat" and within five seconds, press 4 again to listen to the previous message (during playback).
5	<ul style="list-style-type: none"> • Press to repeat the list of remote commands. • Press to stop and return to the remote commands (during playback). • Press to end the recording (during recording announcement).
6	<ul style="list-style-type: none"> • Press to skip to the next message (during playback).

Remote access

7	<ul style="list-style-type: none"> Press to transfer the current message (during playback): Press the handset number (1-9) or * (star key) for the base, then press # (pound key) to transfer a message to the destination mailbox (This option is only available when transferring messages).
8	<ul style="list-style-type: none"> Press to change the personal announcement (This option is only available to handset mailboxes).
9	<ul style="list-style-type: none"> Press to change to the general delivery mailbox (This option is only available to handset mailboxes).
*	<ul style="list-style-type: none"> Press to end the call.

4. Hang up to end the call and save all undeleted messages.

Cut out and carry the remote access wallet card at the back of this user's manual for quick reference.



NOTES:

1. If the auto attendant is active, enter your extension number, wait for your outgoing message to begin, then enter your remote access code.
2. If you do not enter a valid remote access code, the answering system answers the call as usual and all the voice and digits entered will be recorded as message stored in your general mailbox.
3. If you do not enter any remote access code, the answering system announces, "Thank you for calling," and the call is terminated.
4. When there is no new message or all the new messages are played during remote access, you hear a help menu listing all features and commands. If there is no command after the help menu is played three times, the call ends automatically.
5. If you press **4** within five seconds of each message playback start, the previous message plays instead of repeating the current message.

Handset display screen messages

Busy	Failed intercom or conference call (there are already two handsets being used).
Call X:Deskset X	Another system deskset is calling.
Call X:Handset X	Another system handset is calling.
Call log empty	There are no entries in the caller ID history.
Calling X:Deskset X	The handset is starting an intercom call with a deskset.
Calling X:Handset X	The handset is starting an intercom call with another handset.
Charging	A handset is being charged.
COMM L1 L2 L3 L4	There are new voicemail messages.
Directory empty	There are no directory entries.
Ended	You have just ended a call.
Handset Registered	The handset registration was successful.
—Line X— Incoming call	There is an incoming call.
Invalid. Please register the handset to the base.	You are trying to make a call on an unregistered handset.
Line X	The handset is in use.
Low battery	You should place the handset in the charger.
Memory is full	The directory is full. You cannot save any new entries unless you delete some current entries.
Message full	The system memory is full. You cannot record new messages unless you delete some old messages.

Handset display screen messages

-MUTE	The microphone is off.
No link to the base. Please walk closer to the base and try again.	The handset has lost communication with the telephone base.
-PRIV	The call is in privacy mode.
Privacy	A handset tried to join in a call in which call privacy is activated.
Please enter another	The access code you attempted to change has already been used.
Please set alert #	You are trying to confirm the alert number or set the notify alert on or off before you set the alert number.
-REC	The call is being recorded.
Redial list empty	The redial list is empty.
This mailbox is in use.	You are trying to access a mailbox that is in use.
The system is busy. Please try again later.	All the system resources are in use.
XX Missed calls	There are new calls in the caller ID history.

Maintenance

Taking care of your telephone

- Your cordless telephone contains sophisticated electronic parts, so you must treat it with care.
- Avoid rough treatment.
- Place the handset down gently.
- Save the original packing materials to protect your telephone if you ever need to ship it.

Avoid water

- You can damage your telephone if it gets wet. Do not use the handset in the rain, or handle it with wet hands. Do not install the telephone base near a sink, bathtub or shower.

Electrical storms

- Electrical storms can sometimes cause power surges harmful to electronic equipment. For your own safety, take caution when using electric appliances during storms.

Cleaning your telephone

- Your telephone has a durable plastic casing that should retain its luster for many years. Clean it only with a soft cloth slightly dampened with water or a mild soap.
- Do not use excess water or cleaning solvents of any kind.

Remember that electrical appliances can cause serious injury if used when you are wet or standing in water. If the telephone base should fall into water, DO NOT RETRIEVE IT UNTIL YOU UNPLUG THE POWER CORD AND TELEPHONE LINE CORDS FROM THE WALL. Then pull the unit out by the unplugged cords.

Important safety information



This symbol is to alert you to important operating or servicing instructions that may appear in this user's manual. Always follow basic safety precautions when using this product to reduce the risk of injury, fire, or electric shock.

Safety information

- Read and understand all instructions in the user's manual. Observe all markings on the product.
- Avoid using a telephone during a thunderstorm. There may be a slight chance of electric shock from lightning.
- Do not use a telephone in the vicinity of a gas leak. If you suspect a gas leak, report it immediately, but use a telephone away from the area where the gas is leaking. If this product is a cordless model, make sure the telephone base is also away from the area.
- Do not use this product near water, or when you are wet. For example, do not use it in a wet basement or shower, or next to a swimming pool, bathtub, kitchen sink, or laundry tub. Do not use liquids or aerosol sprays for cleaning. If the product comes in contact with any liquid, unplug any line or power cord immediately. Do not plug the product back in until it has dried thoroughly.
- Install this product in a protected location where no one can trip over any line or power cords. Protect cords from damage or abrasion.
- If this product does not operate normally, see the **Troubleshooting** section on pages 78-87 of this user's manual. If you cannot solve the problem, or if the product is damaged, refer to the **Limited warranty** section on pages 74-76. Do not open this product except as directed in your user's manual. Opening the product or reassembling it incorrectly may expose you to hazardous voltages or other risks.
- Replace batteries only as described in your user's manual (see page 7). Do not burn or puncture batteries — they contain caustic chemicals.
- This power adapter is intended to be correctly oriented in a vertical or floor mount position. The prongs are not designed to hold the plug in place if it is plugged into a ceiling or an under-the-table/cabinet outlet.



Caution: Use only the power adapter provided with this product. To obtain a replacement, visit our website at **www.telephones.att.com** or call **1 (888) 915-2007**. In Canada, dial **1 (866) 288-4268**.

Important safety information

Especially about cordless telephones

- **Privacy:** The same features that make a cordless telephone convenient create some limitations. Telephone calls are transmitted between the telephone base and the handset by radio waves, so there is a possibility that your cordless telephone conversations could be intercepted by radio receiving equipment within range of the cordless handset. For this reason, you should not think of cordless telephone conversations as being as private as those on corded telephones.
- **Electrical power:** The telephone base of this cordless telephone must be connected to a working electrical outlet which is not controlled by a wall switch. Calls cannot be made from the handset if the telephone base is unplugged, switched off or if the electrical power is interrupted.
- **Potential TV interference:** Some cordless telephones operate at frequencies that may cause interference to TVs and VCRs. To minimize or prevent such interference, do not place the telephone base of the cordless telephone near or on top of a TV or VCR. If interference is experienced, moving the cordless telephone farther away from the TV or VCR will often reduce or eliminate the interference.
- **Rechargeable batteries:** This product contains nickel-metal hydride rechargeable batteries. Exercise care in handling batteries in order not to create a short circuit with conductive material such as rings, bracelets, and keys. The battery or conductor may overheat and cause harm. Observe proper polarity between the battery and the battery charger.
- **Nickel-metal hydride rechargeable batteries:** Dispose of these batteries in a safe manner. Do not burn or puncture. Like other batteries of this type, if burned or punctured, they could release caustic material which could cause injury.



The RBRC™ Seal means that the manufacturer is voluntarily participating in an industry program to collect and recycle nickel-metal hydride rechargeable batteries when taken out of service within the United States. These batteries may be taken to a participating local retailer of replacement batteries or recycling center. Or you may call 1 (800) 8-BATTERY for locations accepting spent Ni-MH batteries.

Important safety information

Precautions for users of implanted cardiac pacemakers

Cardiac pacemakers (applies only to digital cordless telephones):

Wireless Technology Research, LLC (WTR), an independent research entity, led a multidisciplinary evaluation of the interference between portable wireless telephones and implanted cardiac pacemakers. Supported by the U.S. Food and Drug Administration, WTR recommends to physicians that:

Pacemaker patients

Should keep wireless telephones at least six inches from the pacemaker.

Should NOT place wireless telephones directly over the pacemaker, such as in a breast pocket, when it is turned ON.

Should use the wireless telephone at the ear opposite the pacemaker.

WTR's evaluation did not identify any risk to bystanders with pacemakers from other persons using wireless telephones.

Especially about telephone answering systems

Two-way recording: This unit does not sound warning beeps to inform the other party that the call is being recorded. To ensure that you are in compliance with any federal or state regulations regarding recording a telephone call, you should start the recording process and then inform the other party that you are recording the conversation.

SAVE THESE INSTRUCTIONS

FCC part 68 and ACTA

This equipment complies with Part 68 of the FCC rules and with technical requirements adopted by the Administrative Council for Terminal Attachments (ACTA). The label on the back or bottom of this equipment contains, among other things, a product identifier in the format US:AAAEQ##TXXXX. This identifier must be provided to your telephone service provider upon request.

The plug and jack used to connect this equipment to premises wiring and the telephone network must comply with the applicable Part 68 rules and technical requirements adopted by ACTA. A compliant telephone cord and modular plug is provided with this product. It is designed to be connected to a compatible modular jack that is also compliant. An RJ11 jack should normally be used for connecting to a single line and an RJ14 jack for two lines. See Installation Instructions in the user's manual.

The Ringer Equivalence Number (REN) is used to determine how many devices you may connect to your telephone line and still have them ring when you are called. The REN for this product is encoded as the 6th and 7th characters following the US: in the product identifier (e.g., if ## is 03, the REN is 0.3). In most, but not all areas, the sum of all RENs should be five (5.0) or less. For more information, please contact your telephone service provider.

This equipment may not be used with Party Lines. If you have specially wired alarm dialing equipment connected to your telephone line, ensure the connection of this equipment does not disable your alarm equipment. If you have questions about what will disable the alarm equipment, consult your telephone service provider or a qualified installer.

If this equipment is malfunctioning, it must be unplugged from the modular jack until the problem has been corrected. Repairs to this telephone equipment can only be made by the manufacturer or its authorized agents. For repair procedures, follow the instructions outlined under the Limited Warranty.

If this equipment is causing harm to the telephone network, the telephone service provider may temporarily discontinue your telephone service. The telephone service provider is required to notify you before interrupting service. If advance notice is not practical, you will be notified as soon as possible. You will be given the opportunity to correct the problem and the telephone service provider is required to inform you of your right to file a complaint with the FCC. Your telephone service provider may make changes in its facilities, equipment, operation, or procedures that could affect the proper functioning of this product. The telephone service provider is required to notify you if such changes are planned.

If this product is equipped with a corded or cordless handset, it is hearing aid compatible.

If this product has memory dialing locations, you may choose to store emergency telephone numbers (e.g., police, fire, medical) in these locations. If you do store or test emergency numbers, please:

Remain on the line and briefly explain the reason for the call before hanging up.

Perform such activities in off-peak hours, such as early morning or late evening.

FCC part 68 and ACTA

Industry Canada

Operation is subject to the following two conditions: (1) this device may not cause harmful interference, and (2) this device must accept any interference, including interference that may cause undesired operation.

The term "IC:" before the certification/registration number only signifies that the Industry Canada technical specifications were met.

The Ringer Equivalence Number (REN) for this terminal equipment is 0.1. The REN is an indication of the maximum number of devices allowed to be connected to a telephone interface. The termination on an interface may consist of any combination of devices subject only to the requirement that the sum of the RENs of all the devices does not exceed five.

This product meets the applicable Industry Canada technical specifications.

FCC part 15

This equipment has been tested and found to comply with the requirements for a Class B digital device under Part 15 of the Federal Communications Commission (FCC) rules. These requirements are intended to provide reasonable protection against harmful interference in a residential installation. This equipment generates, uses and can radiate radio frequency energy and, if not installed and used in accordance with the instructions, may cause harmful interference to radio communications. However, there is no guarantee that interference will not occur in a particular installation. If this equipment does cause harmful interference to radio or television reception, which can be determined by turning the equipment off and on, the user is encouraged to try to correct the interference by one or more of the following measures:

- Reorient or relocate the receiving antenna.
- Increase the separation between the equipment and receiver.
- Connect the equipment into an outlet on a circuit different from that to which the receiver is connected.
- Consult the dealer or an experienced radio/TV technician for help.

Changes or modifications to this equipment not expressly approved by the party responsible for compliance could void the user's authority to operate the equipment.

This device complies with Part 15 of the FCC Rules. Operation is subject to the following two conditions: (1) this device may not cause harmful interference, and (2) this device must accept any interference received, including interference that may cause undesired operation. Privacy of communications may not be ensured when using this telephone.

To ensure safety of users, the FCC has established criteria for the amount of radio frequency energy that can be safely absorbed by a user or bystander according to the intended usage of the product. This product has been tested and found to comply with the FCC criteria. The handset may be safely held against the ear of the user. The telephone base shall be installed and used such that parts of the user's body other than the hands are maintained at a distance of approximately 20 cm (8 inches) or more.

If you choose to use a clipping device, please make sure to only use the supplied AT&T belt clip.

This Class B digital apparatus complies with Canadian ICES-003.

Limited warranty

The AT&T brand is used under license - any repair, replacement or warranty service, and all questions about this product should be directed to: In the United States of America, visit **www.telephones.att.com** or call **1 (888) 915-2007**. In Canada, call **1 (866) 288-4268**.

1. What does this limited warranty cover?

The manufacturer of this AT&T-branded product warrants to the holder of a valid proof of purchase (“CONSUMER” or “you”) that the product and all accessories provided in the sales package (“PRODUCT”) are free from defects in material and workmanship, pursuant to the following terms and conditions, when installed and used normally and in accordance with the PRODUCT operating instructions. This limited warranty extends only to the CONSUMER for products purchased and used in the United States of America and Canada.

2. What will be done if the PRODUCT is not free from defects in materials and workmanship during the limited warranty period (“materially defective PRODUCT”)?

During the limited warranty period, the manufacturer’s authorized service representative will repair or replace at the manufacturer’s option, without charge, a materially defective PRODUCT. If the manufacturer repairs the PRODUCT, they may use new or refurbished replacement parts. If the manufacturer chooses to replace the PRODUCT, they may replace it with a new or refurbished PRODUCT of the same or similar design. The manufacturer will retain defective parts, modules, or equipment. Repair or replacement of the PRODUCT, at the manufacturer’s option, is your exclusive remedy. The manufacturer will return repaired or replacement products to you in working condition. You should expect the repair or replacement to take approximately 30 days.

3. How long is the limited warranty period?

The limited warranty period for the PRODUCT extends for ONE (1) YEAR from the date of purchase. If the manufacturer repairs or replaces a materially defective PRODUCT under the terms of this limited warranty, this limited warranty also applies to repaired or replacement PRODUCT for a period of either (a) 90 days from the date the repaired or replacement PRODUCT is shipped to you or (b) the time remaining on the original one-year limited warranty; whichever is longer.

4. What is not covered by this limited warranty?

This limited warranty does not cover:

- PRODUCT that has been subjected to misuse, accident, shipping or other physical damage, improper installation, abnormal operation or handling, neglect, inundation, fire, water, or other liquid intrusion; or

Limited warranty

- PRODUCT that has been damaged due to repair, alteration, or modification by anyone other than an authorized service representative of the manufacturer; or
- PRODUCT to the extent that the problem experienced is caused by signal conditions, network reliability or cable or antenna systems; or
- PRODUCT to the extent that the problem is caused by use with non-AT&T accessories; or
- PRODUCT whose warranty/quality stickers, PRODUCT serial number plates or electronic serial numbers have been removed, altered or rendered illegible; or
- PRODUCT purchased, used, serviced, or shipped for repair from outside the United States of America or Canada, or used for commercial or institutional purposes (including but not limited to products used for rental purposes); or
- PRODUCT returned without a valid proof of purchase (see item 6 below); or
- Charges for installation or setup, adjustment of customer controls, and installation or repair of systems outside the unit.

5. How do you get warranty service?

To obtain warranty service in the United States of America, visit

www.telephones.att.com or call **1 (888) 915-2007**. In Canada, call **1 (866) 288-4268**. NOTE: Before calling for service, please review the user's manual; a check of the PRODUCT controls and features may save you a service call.

Except as provided by applicable law, you assume the risk of loss or damage during transit and transportation and are responsible for delivery or handling charges incurred in the transport of the PRODUCT(s) to the service location. The manufacturer will return repaired or replaced PRODUCT under this limited warranty to you. Transportation, delivery or handling charges are prepaid. The manufacturer assumes no risk for damage or loss of the PRODUCT in transit. If the PRODUCT failure is not covered by this limited warranty, or proof of purchase does not meet the terms of this limited warranty, the manufacturer will notify you and will request that you authorize the cost of repair prior to any further repair activity. You must pay for the cost of repair and return shipping costs for the repair of products that are not covered by this limited warranty.

6. What must you return with the PRODUCT to get warranty service?

You must:

- Return the entire original package and contents including the PRODUCT to the service location along with a description of the malfunction or difficulty; and
- Include a "valid proof of purchase" (sales receipt) identifying the PRODUCT purchased (PRODUCT model) and the date of purchase or receipt; and
- Provide your name, complete and correct mailing address, and telephone number.

Limited warranty

7. Other limitations

This warranty is the complete and exclusive agreement between you and the manufacturer of this AT&T branded PRODUCT. It supersedes all other written or oral communications related to this PRODUCT. The manufacturer provides no other warranties for this PRODUCT. The warranty exclusively describes all of the manufacturer's responsibilities regarding the PRODUCT. There are no other express warranties. No one is authorized to make modifications to this limited warranty and you should not rely on any such modification.

State/Provincial Law rights: This warranty gives you specific legal rights, and you may also have other rights which vary from state to state or province to province.

Limitations: Implied warranties, including those of fitness for a particular purpose and merchantability (an unwritten warranty that the PRODUCT is fit for ordinary use) are limited to one year from date of purchase. Some states/provinces do not allow limitations on how long an implied warranty lasts, so the above limitation may not apply to you. In no event shall the manufacturer be liable for any indirect, special, incidental, consequential, or similar damages (including, but not limited to lost profits or revenue, inability to use the PRODUCT or other associated equipment, the cost of substitute equipment, and claims by third parties) resulting from the use of this PRODUCT. Some states/provinces do not allow the exclusion or limitation of incidental or consequential damages, so the above limitation or exclusion may not apply to you.

Please retain your original sales receipt as proof of purchase.

Technical specifications

RF frequency band	1921.536MHz - 1928.448MHz
Channels	5
Operating temperature	32°F - 122°F 0°C - 50°C
Handset voltage	3.2VDC - 4.2VDC
Charger voltage (AC voltage, 60Hz)	96 Vrms - 127Vrms
Charger voltage (AC adapter output)	9VDC @200mA
Replacement battery	3.6V 600mAH

Operation	Operating time*
Talk time (cordless handset)	Up to five hours
Talk time (cordless handset speakerphone)	Up to five hours
Standby	Up to four days

* Operating times varies depending on your actual use and the age of the battery.

DECT 6.0 digital technology

The AT&T DECT 6.0 products offer unsurpassed range performance and sound clarity. This is achieved through a unique antenna design and advances in noise-filtering technology. An independent laboratory has confirmed that AT&T DECT 6.0 products perform up to 45% better in range competitions. Now calls can be taken in the basement, backyard and garage with exceptional sound quality.

Telephone operating range

This cordless telephone operates within the maximum power allowed by the Federal Communications Commission (FCC). Even so, this handset and telephone base can communicate over only a certain distance — which can vary with the locations of the telephone base and handset, the weather, and the construction of your building.

Troubleshooting

If you have difficulty with your phone, please try the suggestions below. For customer service, visit our website at

www.telephones.att.com, or call **1 (888) 915-2007**.

In Canada dial **1 (866) 288-4268**.

My phone doesn't work at all.

- Make sure the power cord is securely plugged in.
- Make sure you plug the battery connector securely into the cordless handset.
- Make sure you plug the telephone line cord securely and firmly into the telephone base and the telephone wall jack.
- Charge the battery in the cordless handset for at least 16 hours. For optimum daily performance, return the cordless handset to the charger when not in use.
- If the battery is depleted, it might take approximately 10 minutes to charge the handset.
- Reset the telephone base. Unplug the electrical power. Wait for approximately 15 seconds, then plug it back in. Allow up to one minute for the cordless handset and telephone base to reset.
- You may need to purchase a new battery. Please refer to **Handset battery installation and charging** in this user's manual.

I cannot get a dial tone.

- First try all the suggestions above.
- Move the cordless handset closer to the telephone base. You might have moved out of range.
- If the previous suggestions do not work, disconnect the telephone base from the telephone jack and connect the jack to a different phone. If there is no dial tone on that phone either, the problem is in your wiring or local service. Contact your telephone service provider.
- Your line cord might be malfunctioning. Try installing a new line cord.

Troubleshooting

I cannot dial out.

- First try all the suggestions on the previous page.
- Make sure you have a dial tone before dialing. The cordless handset might take a second or two to find the telephone base and produce a dial tone. This is normal. Wait an extra second before dialing.
- Eliminate any background noise. Noise from a television, radio or other appliances might cause the phone to not dial out properly. If you cannot eliminate the background noise, first try muting the cordless handset before dialing, or dialing from another room with less background noise.
- If the other phones in your building are having the same problem, contact your telephone service provider (charges might apply).

My cordless handset isn't performing normally.

- Make sure you plug the power cord securely into the telephone base. Plug the power adapter into a different, working electrical outlet without a wall switch.
- Move the cordless handset closer to the telephone base. You might have moved out of range.
- Reset the telephone base. Unplug the electrical power. Wait for 15 seconds then plug it back in. Allow up to one minute for the cordless handset and telephone base to reset.
- Other electronic products such as HAM radios and other DECT phones can cause interference with your cordless phone. Try installing your phone as far away as possible from these types of electronic devices.

Troubleshooting

The batteries do not hold a charge.

- If the cordless handset is in the charger and the charge light is not on, refer to **The charge light is off** in this Troubleshooting guide.
- Charge the battery in the cordless handset for at least 16 hours. For optimum daily performance, return the cordless handset to the charger when not in use.
- If the battery is depleted, it might take approximately four minutes to charge the handset before it can resume display on the screen.
- You might need to purchase a new battery. Please refer to **Handset battery installation and charging** in this user's manual.

I experience poor sound quality when using the speakerphone.

- For increased sound quality while using the handset speakerphone, place the handset on a flat surface with the dial pad facing up.
- Excessive background noise will cause a speakerphone to fade in and out. Try controlling the background noise by turning off any audio devices near the speakerphone. Also, try to avoid interrupting the person at the other end of the conversation while they are speaking. If background noise cannot be controlled, you should stop speakerphone operation and return to normal handset mode.
- When using a speakerphone, controlling background noise in your environment is essential. While you are listening to your party, press **MUTE** to temporarily turn your microphone off. When it is your turn to speak, remember to press **MUTE** again to turn the microphone on.

Troubleshooting

I get noise, static, or weak signals even when I'm near the telephone base.

- If you subscribe to high-speed Internet service (DSL - digital subscriber line) through your telephone lines, you must install a DSL filter between the telephone line cord and the telephone wall jack. The filter prevents noise and caller ID problems as a result of DSL interference. Please contact your DSL service provider for more information about DSL filters.
- You may be able to improve the performance of your cordless phone by installing your new telephone base as far as possible from any other existing cordless telephone system that may already be installed.
- Other electronic products such as HAM radios and other DECT phones can cause interference with your cordless phone. Try installing your phone as far away as possible from these types of electronic devices.
- Do not install this phone near a microwave oven or on the same electrical outlet. You might experience decreased performance while the microwave oven is operating.
- If you plug your phone in with a modem or a surge protector, plug the phone (or modem/surge protector) into a different location. If this does not solve the problem, relocate your phone or modem farther apart from one another, or use a different surge protector.
- Move your phone to a higher location. The phone might have better reception in a high area.
- If the other phones in your building are having the same problem, contact your telephone service provider (charges may apply).

I hear other calls while using my phone.

- Disconnect the telephone base from the telephone jack, and plug in a different telephone. If you still hear other calls, call your telephone service provider (charges may apply).

Troubleshooting

My cordless handset does not ring when I receive a call.

- Make sure that the ringer is not off. Refer to the section on ringer selection in this user's manual.
- Make sure you plug in the telephone line cord securely into the telephone base and the telephone jack. Make sure you plug in the power cord securely.
- The cordless handset may be too far from the telephone base.
- Charge the battery in the cordless handset for at least 16 hours. For optimum daily performance, return the cordless handset to the charger when not in use.
- You may have too many extension phones on your telephone line to allow all of them to ring simultaneously. Try unplugging some of the other phones.
- The layout of your building might be limiting the operating range. Try moving the telephone base to another location, preferably on an upper floor.
- If the other phones in your building are having the same problem, contact your telephone service provider (charges may apply).
- Test a working phone at the phone jack. If another phone has the same problem, contact your telephone service provider (charges may apply).
- Other electronic products such as HAM radios and other DECT phones can cause interference with your cordless phone. Try installing your phone as far away as possible from these types of electronic devices.
- Install the battery again, and place the cordless handset in the charger. Wait for the cordless handset to reestablish its connection with the telephone base. Allow up to one minute for this to take place.
- Your line cord might be malfunctioning. Try installing a new line cord.

Troubleshooting

My calls cut in and out while I'm using my cordless handset.

- Other electronic products such as HAM radios and other DECT phones can cause interference with your cordless phone. Try installing your phone as far away as possible from these types of electronic devices.
- Do not install this phone near a microwave oven or on the same electrical outlet. You might experience decreased performance while the microwave oven is operating.
- If you plug your phone in with a modem or surge protector, plug the phone (or modem/surge protector) into a different location. If this does not solve the problem, relocate your phone or modem farther apart from one another, or use a different surge protector.
- Relocate your telephone base to a higher location. The phone might have better reception when installed in a high area.
- If the other phones in your building are having the same problem, contact your telephone service provider (charges may apply).
- Excessive background noise will cause a speakerphone to fade in and out. Try controlling the background noise by turning off any audio devices near the speakerphone. Also, try to avoid interrupting the person at the other end of the conversation while they are speaking. If background noise cannot be controlled, you should stop speakerphone operation and return to normal handset mode.
- When using a speakerphone, controlling background noise in your environment is essential. While you are listening to your party, press **MUTE** to temporarily turn your microphone off. When it is your turn to speak, remember to press **MUTE** again to turn the microphone on.

Troubleshooting

The charge light is off.

- Make sure you plug the power and line cords in correctly and securely.
- Unplug the electrical power. Wait for 15 seconds, then plug it back in. Allow up to one minute for the cordless handset and telephone base to reset.
- Clean the cordless handset and telephone base charging contacts each month with a pencil eraser or cloth.

My caller ID isn't working.

- Caller ID is a subscription service. You must subscribe to this service from your telephone service provider for this feature to work on your phone.
- The caller must be calling from an area that supports caller ID.
- Both your and your caller's telephone service providers must use caller ID compatible equipment.
- If you subscribe to high-speed Internet service (DSL - digital subscriber line) through your telephone lines, you must install a DSL filter between the telephone line cord and the telephone wall jack. The filter prevents noise and caller ID problems resulting from DSL interference. Please contact your DSL service provider for more information about DSL filters.

System does not receive caller ID when on a call.

- Make sure you subscribe to caller ID with call waiting features from your telephone service provider. Caller ID features works only if both you and the caller are in areas offering caller ID service, and if both telephone service providers use compatible equipment.

Troubleshooting

The answering system is recording incomplete messages.

- If a caller leaves a very long message, part of it may be lost when the system disconnects the call after three minutes.
- If the caller pauses for longer than six seconds, the system stops recording and disconnects the call.
- If the system's memory becomes full during a message, the system stops recording and disconnects the call.
- If the caller's voice is very soft, the system may stop recording and disconnects the call.

I have difficulty hearing messages.

- Press **VOLUME ▲** to increase speaker or listening volume on a handset.

System does not record messages.

- Make sure the auto attendant is on. Please refer to **Turn the auto attendant on** in the SynJ SB67118/SB67138 telephone base manual.
- Make sure the memory of the answering system is not full. Please refer to **Remaining space** in the SynJ SB67118/SB67138 telephone base manual. When the answering system memory is full, it does not record new messages until some old messages are deleted.
- If you subscribe to voicemail service, change the number of rings so that your answering system answers before your voicemail answers. To determine how many rings activate your voicemail, contact your local telephone service provider (charges may apply).
- If there is a fax machine connected to the same telephone line, try disconnecting the fax machine. If that solves the problem, consult your fax machine documentation for information on compatibility with answering systems.

Troubleshooting

System does not respond to remote commands.

- Make sure to enter your remote access code correctly (see page 19).
- Make sure you are calling from a touch-tone phone. When you dial a number, you should hear tones. If you hear clicks, the phone is not a touch-tone telephone and cannot activate the answering system.
- The answering system may not detect the remote access code while your announcement is playing. Try waiting until the announcement is over before entering the code.
- There may be interference on the phone line you are using. Press dial pad keys firmly.

Outgoing announcement is not clear.

- When you record your announcement, make sure you speak in a normal tone of voice, about nine inches from the telephone base.
- Make sure there is no background noise (TV, music, etc.) while recording.

I cannot retrieve voicemail messages.

- Your telephone has both a built-in answering system and voicemail indication. They are independent features and each alerts you to new messages differently (page 57). If you subscribe to voicemail service from your telephone service provider (charges may apply), contact your telephone service provider for more information on how to access your voicemail.

Troubleshooting

Common cure for electronic equipment.

If the telephone does not respond normally, try putting the cordless handset in the charger. If it does not seem to respond, do the following (in the order listed):

- Disconnect the power to the telephone base.
- Disconnect the cordless handset battery, and spare battery, if applicable.
- Wait a few minutes.
- Connect power to the telephone base.
- Install the battery again, and place the cordless handset into the charger.
- Wait for the cordless handset to reestablish its connection with the telephone base. Allow up to one minute for this to take place.

Index

A

- AC adapter, 4
- Access code, 19, 63
- Adding new handsets, 8
- Alert tones, 18
- Announcement, 22
- Answering calls, 24
- Answering system, 56-64
- Auto off, 25

B

- Battery charging, 5-7
- Battery installation, 5-7
- Belt clip, 11

C

- Call privacy, 27
- Call transfer, 37
- Call waiting, 27
- Caller ID (CID), 48
 - add entries to phone
 - directory, 54
 - delete entries, 53
 - dial entries, 53
 - review entries, 52
- Capacity, 41
- Chain dialing, 31
- Charger installation, 4
- Conference call, 32
- COVM, 34
- Customer support, 17

D

- Delete call log entries, 53
- Delete redial entries, 26
- Deliver a memo, 62
- Dialing,
 - directory dialing, 47
 - from a record in the caller ID history, 53
- Directory,
 - capacity, 41
 - create entries, 42
 - dial number, 47
 - edit entries, 47
 - name search, 46
 - Display dial, 47
- DSL, 3

E

- Elapsed time, 23
- Ending calls, 23

F

- Flash (switch hook flash), 27

Index

H

- Hands-free use, 11
- Handset,
 - central office voicemail indicator, 34
 - deregistration, 10
 - key tone, 14
 - quick reference guide, 1
 - registration, 8
 - ringer tone, 13
 - ringer volume, 12
 - screen display message, 65
 - settings, 12
 - new message indicator, 58
- Hold, 30
- Hold reminder, 16

I

- Incoming caller ID history, 52
- Incoming calls, answering, 24
- Indicator lights, 18
- Indicator tone, 18
- Installation, 3
- Intercom, 35

J

- Join a call in progress, 31

K

- Key tone, 14

L

- Language, 14
- Last number redial, 26
- LCD contrast, 13
- Limited warranty, 74
- Line selection, 15

M

- Maintenance, 67
- Making calls, 23
- Memory match, 51
- Menu settings, 12
- Message memo, 62
- Message playback, 59
- Missed calls indicator, 51
- Mute, 29

N

- Names,
 - enter into directory, 42
 - search for, 46
- Navigation key, 1
- New message indication, 58
- Notify alert, 20

O

- On hook dialing, 23

P

- Pause, 43
- Phonebook (directory), 41
- Play back a message memo, 59
- Power adapter, 4
- Predialing, 23
- PTT, 38

Index

Q

Quick reference guide, 1-2

R

Receiving calls, 24

Recharging, 7

Record

 a call, 28

 message memo, 62

 announcement, 22

Redial, 26

Registration, 8

Remote access, 63

Review directory entries, 45

Review the caller ID history, 52

Ring silencing, 25

Ring tone options, 13

Ringer volume, 12

S

Safety information, 68

Screen display messages, 65

Screen icons, 18

Search by name, 46

Speakerphone, 23

Speed dial, 17

T

Technical specifications, 77

Telephone operating range, 77

Temporary ringer silencing, 25

Three-way conference calls, 32

Transfer a call, 37

Troubleshooting, 78

V

Voicemail, 34

Voice prompts, 58

Volume control, 27

W

Warranty, 74

Remote access wallet card

Use the wallet card below to help you remember commands to control your answering system from any touch-tone telephone.

Cut along dotted line.



Call your telephone number, then enter your four-digit access code (preset to **0001** for **Handset 1** and so on).

Action

Remote command

Play all messages or record announcement.....	1
Accept the recorded announcement.....	2
Delete the message or recorded announcement.....	3
Repeat or go back.....	4
Help menu or end the recording.....	5
Skip the message.....	6
Transfer the message.....	7
Transfer message to other mailbox.....	(Mailbox number) + #
Change the announcement.....	8
Change to the general delivery mailbox.....	9
End remote access call.....	* (or hang up)

Fold here.

Model name: SynJ SB67108

**Type: DECT 6.0 expansion handset for use with AT&T model
SynJ SB67118/SB67138**

© 2009-2011 Advanced American Telephones. All Rights Reserved. AT&T and the AT&T logo are trademarks of AT&T Intellectual Property licensed to Advanced American Telephones, San Antonio, TX 78219. Printed in China. SynJ™ is a trademark of Advanced American Telephones.



www.telephones.att.com

© 2009-2011 Advanced American Telephones. All Rights Reserved.
AT&T and the AT&T logo are trademarks of AT&T Intellectual Property licensed to
Advanced American Telephones, San Antonio, TX 78219.
SynJ™ is a trademark of Advanced American Telephones.
Printed in China. Issue 8 AT&T 01/11.