



at&t

User's manual

TR1909

**Trimline[®] telephone
with caller ID/call waiting**

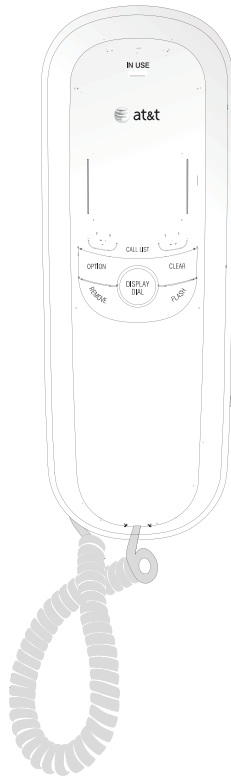

Congratulations

on purchasing your
new AT&T product.

Before using this AT&T product, please
read the **Important product information**
on pages 29-30 of this manual.

Please thoroughly read the user's
manual for all the feature operations
and troubleshooting information necessary to install
and operate your new
AT&T product. You can also visit our
website at **www.telephones.att.com**
or call **1 (800) 222-3111**.
In Canada, dial **1 (866) 288-4268**.

Model #: TR1909

Product name: Trimline telephone with caller ID/call waiting

Serial #:

(found on the bottom of the telephone base)

Purchase date: _____

Place of purchase: _____

© 2009 Advanced American Telephones. All rights reserved.

AT&T and the AT&T logo are trademarks of AT&T Intellectual Property II, L.P. d/b/a

AT&T Intellectual Property licensed to Advanced American Telephones, San Antonio, TX 78219.

Trimline® is a registered trademark of Advanced American Telephones.

Parts checklist

Save your sales receipt and original packaging in the event warranty service is necessary.

Your telephone contains the following items:



User's manual



Quick start guide



Handset

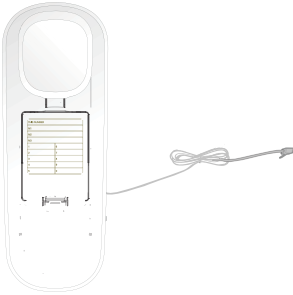

Telephone base with mounting bracket attached for tabletop position (telephone line cord installed)

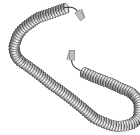

Coiled handset cord



Mounting bracket (attached)



Directory card (stuck on the cover of the battery compartment)

TR1909

Trimline telephone with caller ID/call waiting



Table of contents

Getting started

Product overview	1
Handset layout	2
Screen display messages	3
Screen icons.....	3
Screen display messages.....	3
Installation preparation.....	4
Battery installation.....	5
Telephone installation	6
Installation options.....	7
Wall installation	7
Tabletop installation	8

Telephone settings

About the feature menu.....	10
Feature summary.....	10
Contrast	11
Home area code	11
Local area code.....	12
Time and date.....	13
Call waiting	14
Language.....	15
Tone/pulse.....	15

Telephone operation

Basic telephone operation	16
Make and answer a call	16
Last number redial.....	16
Adjust ringer volume	16
Adjust listening volume.....	16
Options while on calls.....	17
Flash.....	17
Mute	17
Temporary tone dialing	17

Telephone memory

Memory operation (one-touch)	18
To store a number in one-touch.....	18
To review a number in	

one-touch.....	18
To dial a number in one-touch....	18
Memory operation (two-touch).....	19
To store a number in two-touch.....	19
To review a number in two-touch.....	19
To dial a number in two-touch....	19
Directory card	19

Caller ID operation

Caller ID overview.....	20
About caller ID.....	20
How caller ID works.....	21
Caller ID special messages.....	22
How call log works.....	22
Reviewing the call log	23
To review the call log.....	23
To dial the displayed number.....	23
Deleting call log entries	24
To delete a call log entry.....	24
To delete all call log entries.....	24
Copying a call log entry into memory.....	25

Appendix

Troubleshooting.....	26
Maintenance.....	28
Important product information.....	29
Safety information.....	29
Especially about corded telephones.....	30
Especially about telephones answering systems.....	30
FCC and ACTA information.....	31
Part 15 of FCC rules.....	33
Limited warranty.....	34
Technical specifications	37
Index.....	38

Product overview

This AT&T TR1909 trimline with caller ID/call waiting can be used either in tabletop or wall installation position, and requires four AA alkaline batteries (not included) for battery-powered functions. The telephone can still operate with limited features when there are no batteries installed.

The TR1909 also features a 13-number memory for fast dialing and has a call log which can store up to 80 additional numbers with names. This telephone has a caller ID feature which supports caller ID with call waiting service. (Caller ID services are subscriber services available from your local telephone companies for a fee.)

This user's manual contains detailed instructions for installing and operating your AT&T TR1909 trimline with caller ID/call waiting. Please follow the instructions carefully.

Handset layout

IN USE

Flashes quickly when there is an incoming call.
Flashes slowly when the telephone line cord is not plugged into a wall jack or another telephone at the same line is in use.

OPTION

Press to display the setting options.
While in the option menu, press to save the selection and move to the next feature (page 10).

REMOVE

While viewing the call log, press to delete entry currently displayed, press and hold to remove all entries (page 24).

CALL LIST ▼ / ▲

When the telephone is in idle mode, press to display caller ID information (page 23).

CLEAR

Press to exit dialing, to exit storing a number in memory, to exit the call log, or to return to the idle screen anytime without saving the changes.

DISPLAY DIAL

Press to dial the number currently displayed (page 23).

FLASH

When there is a call waiting signal, press **FLASH** to put the current call on hold and connect to the new call. Press **FLASH** again to return to the original call. Also, press **FLASH** to activate other telephone company subscriber services such as three-way calling (page 17).

M1, M2, M3

Press to dial a one-touch number from the memory (page 18).

Listening volume

Adjust the handset listening volume to **LO**, **MED**, or **HI** (page 16).

MEMORY

Press to access telephone numbers stored in the memory (page 19).

MUTE

Press and hold **MUTE** to silence the microphone to prevent the other party from hearing you, but you will still be able to hear the other party. Release **MUTE** to return to the original two-way conversation (page 17).

Switch hook

When held, the telephone is in idle mode.
When released, the telephone is ready to make a call.

PAUSE/REDIAL

When the handset is lifted, press to redial the last number dialed (page 16).
When storing a number in the memory, press to insert a 3-second pause in the dialing sequence.

PROG

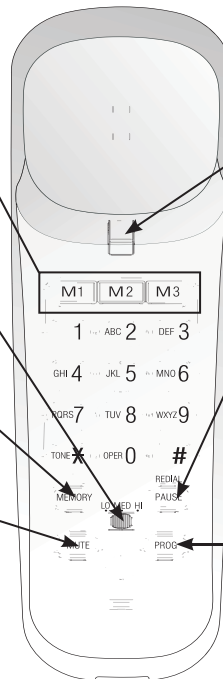
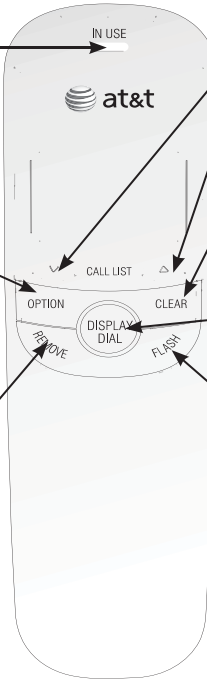

Press to store a telephone number in the memory (page 18).



Screen display messages



Screen icons

CALL#	Call number in the call log.
NEW	New (unreviewed) call.
REP	Repeat call from the same number.
	<ul style="list-style-type: none">The telephone line cord is not plugged into the wall jack.The telephone or another telephone on the same line is in use.
	The battery power is low.

Screen display messages

REMOVE ALL?	Remove all call log entries.
END OF LIST	You have reached the end of the call log entries.
Pro	Program a one-touch or two-touch memory.
LIFT RECEIVER	A caller ID entry is ready to be dialed by lifting the handset.
TOTAL XX NEW XX	The total and new (unreviewed) calls in the call log.

Installation preparation

Make sure to install four AA alkaline batteries (not included) before using the telephone.



See page 5 for easy instructions.

If you subscribe to high-speed Internet service (digital subscriber line - DSL) through your telephone lines, you must install a DSL filter between the telephone line cord and the telephone wall jack. The filter prevents noise and caller ID problems caused by DSL interference. Please contact your DSL service provider for more information about DSL filters.

Your product may be shipped with a protective sticker covering the handset or telephone base display - remove it before use.

For customer service or product information, visit our website at **www.telephones.att.com** or call **1 (800) 222-3111**. In Canada, dial **1 (866) 288-4268**.



CAUTION: To reduce the risk of fire or injury to persons or damage to the telephone, read and follow these instructions carefully:

- Use only AA alkaline batteries (not included).
- Observe proper polarity orientation between the battery and metallic contacts.
- Do not disassemble your telephone. There are no user serviceable parts inside. Refer to qualified service personnel for servicing.

Battery installation

Before using the telephone, you should install four good AA alkaline batteries (not included) to provide memory backup and enable the use of some features. The four AA batteries are required for caller ID features and the **IN USE** light to work. If good batteries are not installed, the display only works when you lift the handset.

If you unplug the telephone from the wall jack, or you lose telephone service for over 10 minutes, and good batteries are not installed, the following information is lost: call list, numbers stored in one- and two-touch memory, redial list, and all settings in the feature menu. It is recommended that you initially install new batteries and change the batteries soon after the low battery icon appears.

1. Press on the tab to open the cover of the battery compartment.
2. Install four new AA batteries (not included) in the battery compartment according to the label + and - engraved in the compartment.
3. Close the battery compartment cover. Make sure it clicks into place.

Step 1

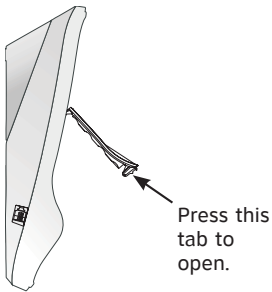

Step 2

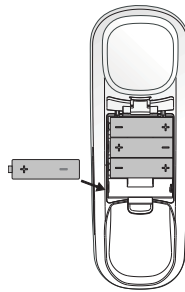

Step 3



NOTES:

- Do not mix old and new batteries and do not mix alkaline and standard (carbon-zinc) batteries.
- When the batteries are installed, the screen will show 12:00 and the clock will begin to run. It will reset to the correct time when the first caller ID data is received.
- Always disconnect all telephone lines from the wall outlets before replacing batteries.
- Install new batteries every six months to maintain the call log and telephone memory.

Telephone installation

If you subscribe to high-speed Internet service (digital subscriber line - DSL) through your telephone lines, you must install a DSL filter between the telephone line cord and the telephone wall jack. The filter prevents noise and caller ID problems caused by DSL interference. Please contact your DSL service provider for more information about DSL filters. Install the telephone as shown below.

1. Plug one end of the coiled handset cord into the handset jack on the left side of the telephone base. Plug the other end into the handset.
2. One end of the telephone line cord has been plugged into the telephone jack on the bottom of the telephone base. Double check that it is plugged in firmly.
3. Thread the cord through the channel and out of the mounting area as shown.
4. Plug the other end of the telephone line cord into a telephone wall jack.
5. Put the handset on the telephone base.

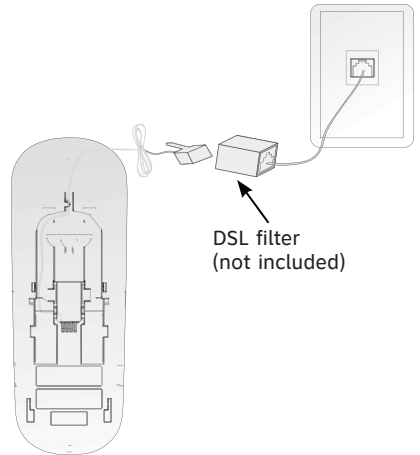

Installation options

Your telephone base is ready for tabletop use. If you want to mount your telephone on a wall, use the provided wall mount bracket to connect with a standard dual-stud telephone wall mounting plate. If you do not have this mounting plate, you can purchase one from many hardware or consumer electronic retailers. You might need a professional to install the mounting plate.

Wall installation

To install the telephone base in the wall mount position, make sure that you first unplug all cords connected to the telephone base.

1. Lift the handset and place it aside. On the telephone base, pull out the handset tab and rotate it 180 degrees. Replace the handset tab back to the grooves until it clicks into position.

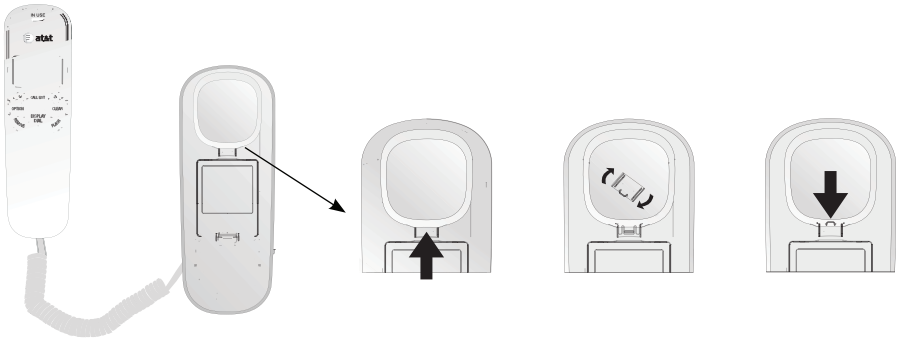

2. Remove the bracket from the base, hold the telephone base with both hands, slide the bracket upwards as the arrows indicate.

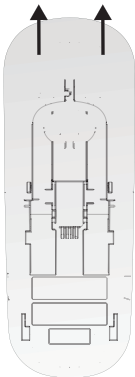

3. Rotate the bracket to the wall installation position, push the bracket upwards as shown below until it clicks into place.

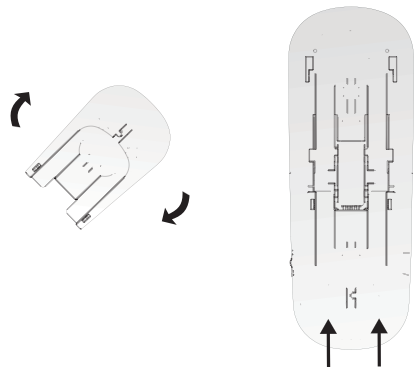

Installation options

4. Route the telephone line cord through the slot as shown below and plug the other end of the telephone line cord into a telephone wall jack. To mount the telephone on the wall, position the mounting holes A and B over the telephone outlet mounting studs. Slide the bracket down firmly so the telephone is held securely on the telephone outlet mounting studs.
5. Place the handset back on the telephone base.

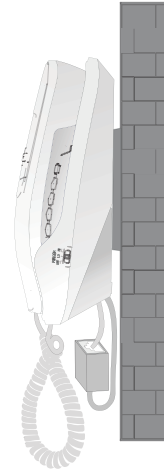
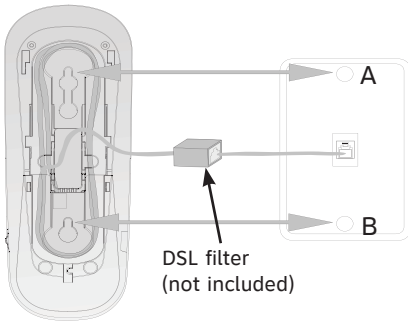

Tabletop installation

To return the bracket from the wall installation to tabletop use, follow the instructions below.

1. Remove the telephone base from the wall mounting plate. Unplug the telephone line cord from the telephone wall jack and remove the cord from the slots under the telephone base.
2. Lift the handset and place it aside. On the telephone base, pull out the handset tab and rotate it 180 degrees. Replace the handset tab back to the grooves until it clicks into position.

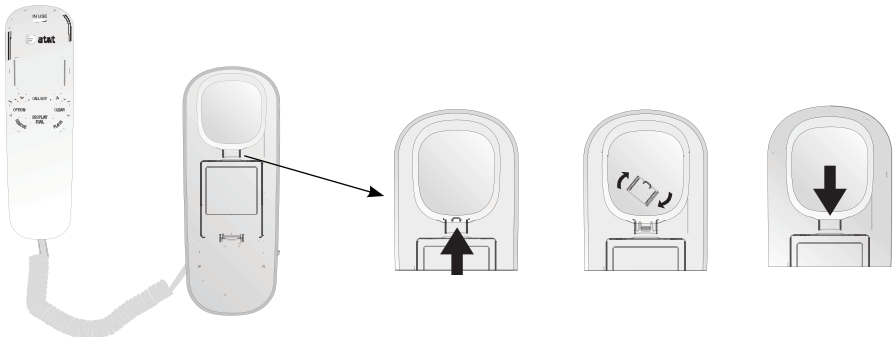

Installation options

3. Remove the bracket from the base, hold the telephone base firmly, slide the bracket downwards as the arrows indicate.

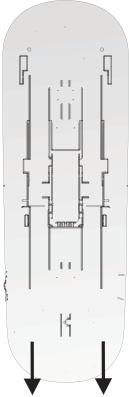

4. Rotate the bracket to the tabletop installation position, push the bracket down as shown below until it clicks into place.

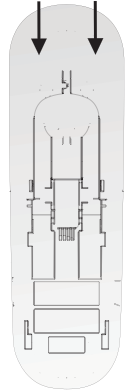
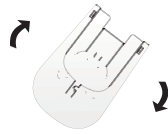

5. Route the telephone line cord through the slot as shown below. Plug the other end of the telephone line cord into the telephone wall jack.

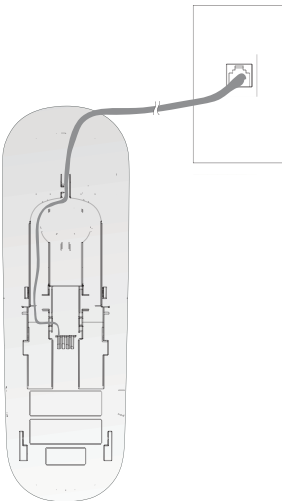

6. Place the handset back on the telephone base.

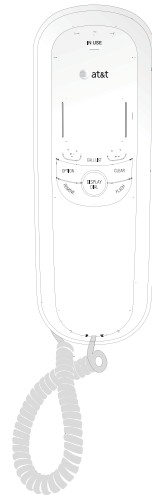

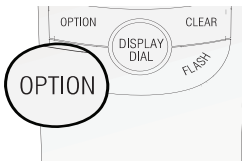

i NOTE: Press **OPTION** within ten seconds after choosing a setting to save and advance to the next feature.

About the feature menu

The table below provides a summary of the feature menu. Use the instructions below to change a feature in the menu:

1. When the telephone is in idle mode, press **OPTION** repeatedly until the screen displays the desired feature.
2. Press ▼ or ▲ until the screen displays the desired setting.
3. Press **OPTION** to save your selection and move to the next feature.

-OR-

Press **CLEAR** to exit without saving your selection and return to idle mode.

-OR-

Wait 10 seconds, the telephone returns to idle mode automatically.

Feature summary

Default settings are indicated by an asterisk (*).

Screen display	Function	Options
SET CONTRAST	Adjust the screen brightness to a comfortable level, from 1 (lightest) to 5 (darkest). The contrast may be different for table setting and for wall mounting.	1, 2, 3*, 4, 5
HOME AREA CODE?	Set the telephone to recognize calls from the home area code.	HAC - ___
LOCAL AREA CODE?	Program up to four area codes which may not require dialing 1 before them.	LAC 1- ___ LAC 2- ___ LAC 3- ___ LAC 4- ___
SET TIME/DATE	Set the time and date on the handset.	12:00^{AM}, 1/01
CALL WAITING?	Choose to allow the telephone to show the caller ID information of call-waiting calls and store them in the call log.	ON*, OFF
SET TONE/PULSE	Set whether the telephone should be tone dial or pulse dial.	TONE* PULSE
SET LANGUAGE	Choose the screen display language.	ENGLISH*, FRANCAIS ESPANOL

i NOTE: The features are listed in the order they appear after the initial setup. When you first install batteries, the orders are: SET LANGUAGE, SET CONTRAST, HOME AREA CODE, LOCAL AREA CODE, SET TIME/DATE, CALL WAITING, SET TONE/PULSE.

Contrast

This feature allows you to adjust the screen contrast level for different lighting conditions.



1. Press **OPTION** repeatedly until the screen displays **SET CONTRAST**.
2. Press **▼** or **▲** to select the desired screen contrast level from 1 (lightest) to 5 (darkest).
3. Press **OPTION** to save your selection and move to the next feature.

- OR -

Press **CLEAR** to exit without saving your selection and return to idle mode.

Home area code

Home area code is the area code associated with your telephone number. It is necessary to program a home area code so the telephone can properly display incoming calls and dial the telephone numbers from the call log.

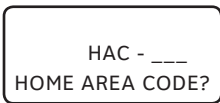

1. Press **OPTION** repeatedly until you see **HOME AREA CODE?**
2. Press the **▼** or **▲** to enter the first digit of the home area code. Use **▼** or **▲** to decrease or increase the number.
3. Press **DISPLAY DIAL** to save the digit and advance to the next digit.
4. Repeat steps 2 and 3 for the second and third digits of your home area code.
5. Press **OPTION** to save the home area code and continue to set the local area code.

For calls within your area codes:

Dial	Enter in step 2:
7 digits (phone number, no area code)	Your area code
10 digits (area code + phone number)	000
11 digits (1 + area code + phone number)	000

Local area codes

Local area codes are area codes associated with other telephone numbers for which you must dial the area code, but do not need to dial **1**. This includes your own area code if you must dial the area code but not **1** to make calls in your own area code.

Up to four local area codes can be programmed. Do not program area codes for which you must dial a **1**.

LAC 1 - ____
LOCAL AREA CODE?

LAC 2 - ____
LOCAL AREA CODE?

LAC 3 - ____
LOCAL AREA CODE?

LAC 4 - ____
LOCAL AREA CODE?

1. Press **OPTION** until you see **LOCAL AREA CODE?**
2. Press the **▼** or **▲** to enter the first digit of the local area code in **LAC 1**. Use **▼** or **▲** to decrease or increase the number.
3. Press **DISPLAY DIAL** to move to next digit of the local area code and repeat step 2.
4. Press **OPTION** to save your selection and move to next local area code (**LAC 2**, **LAC 3** or **LAC 4**).
5. Press **OPTION** to save your selection and move to the next feature when you have finished entering local area codes.

- OR -

Press **CLEAR** to exit without saving your selection and return to idle mode.

For calls outside your area codes:

For:	Dial:
All calls outside your area code	11 digits (1+ area code + telephone number)
Some calls outside your area code	10 digits (area code + telephone number)
If you dial 10 digits (area code + phone number) for calls within your own area code, include your area code as a local area code.	

Time and date

This feature allows you to set the time and date when the telephone is in idle mode. If you subscribe to caller ID service, the time and date are set automatically by the incoming caller ID information.

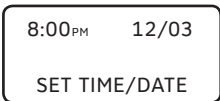
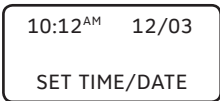
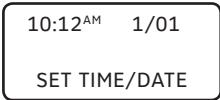

1. Press **OPTION** repeatedly until the screen displays **SET TIME/DATE**.
2. When the hour is flashing, use the ▼ and ▲ keys to scroll through the list of numbers from **1** to **12** to select the right number for the hour and **AM** or **PM**. Press **DISPLAY DIAL** to save the entry and advance to the next setting.
3. When the minutes are flashing, use the ▼ and ▲ keys to scroll through the list of numbers from **00** to **59** to select the right number for the minutes. Press **DISPLAY DIAL** to save the entry and advance to the next setting.
4. When the month is flashing, use the ▼ and ▲ keys to scroll through the list of numbers from **1** to **12** to select the right number for the month. Press **DISPLAY DIAL** to save the entry and advance to the next setting.
5. When the day is flashing, use the ▼ and ▲ keys to scroll through the list of numbers from **1** to **31** to select the right number for the date. Press **DISPLAY DIAL** to return to step 2 above to make any corrections.
- OR -
Press **OPTION** to save the entry and advance to **CALL WAITING?**
- OR -
Press **CLEAR** to exit without saving your selection and return to idle mode.

 **NOTE:** When entering the hours, after **11AM** is **12PM**, and after **11PM** is **12AM**.

Call waiting

If you subscribe to caller ID and call waiting service provided by your local telephone company (page 20), select **ON** in this feature to enable the telephone to show the caller ID information of those call-waiting calls (page 21) and store them in the call log. If you do not subscribe to caller ID or call waiting service provided by your local telephone company, select **OFF** in this feature.

CALL WAITING?

ON

1. Press **OPTION** repeatedly until the screen displays **CALL WAITING?**
2. Press **▼** or **▼** to select **ON** or **OFF**.
3. Press **OPTION** to save your selection and move to the next feature.

-OR-

Press **CLEAR** to exit without saving your selection and return to idle mode.



NOTE: If you subscribe to call waiting service with your local telephone company, you can put your current call on hold by pressing **FLASH** to take the new incoming call (page 17).

Language

This telephone comes factory set for English displays. If you wish to change the displayed language to Spanish or French, follow the steps below:



1. Press **OPTION** repeatedly until the screen displays **SET LANGUAGE**.
2. Press **▼** or **▲** to select the desired language displayed on the screen (**ENGLISH**, **FRANCAIS** or **ESPAÑOL**).
3. Press **OPTION** to save your selection and move to the next feature.
-OR-
Press **CLEAR** to exit without saving your selection and return to idle mode.

Tone/pulse

This telephone comes factory set for touch-tone dialing. If you do not have touch tone dialing service, you can change this setting to **PULSE** by following the steps below:



1. Press **OPTION** repeatedly until the screen displays **SET TONE/PULSE**.
2. Press **▼** or **▲** to select the dialing mode between **TONE** and **PULSE**.
3. Press **OPTION** to save your selection and return to idle mode.
-OR-
Press **CLEAR** to exit without saving your selection and return to idle mode.

 **NOTE:** If you have pulse dial (rotary) service, you can temporarily switch to touch-tone dialing during a call by pressing **TONE*** (page 17). After hanging up or pressing **FLASH**, the telephone automatically returns to its original dial mode.

Basic telephone operation

Make and answer a call

To make a call:

1. Lift the handset and wait for a dial tone.
2. Then use the dial pad keys (**0** through **9**, ***** or **#**) to enter the number you want to dial. Place the handset on the telephone base to hang up.

To answer a call:

1. Lift the handset.
2. Place the handset on the telephone base to hang up.

Last number redial

To redial the last number you dialed out (up to 32 digits), follow the steps below:

1. Lift the handset and wait for a dial tone.
2. Then press **REDIAL** on the handset.
3. Place the handset on the telephone base to hang up.

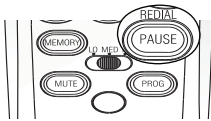

Adjust ringer volume

To adjust the ringer volume, slide the **RINGER** switch on the right side of the telephone base. You can set the ringer to off, low or high (**OFF**, **LO** or **HI**).

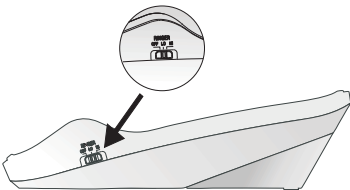

Adjust listening volume

To adjust the listening volume, slide the volume switch on the handset. You can set the listening volume to low, medium or high (**LO**, **MED** or **HI**).

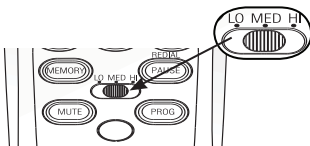

Options while on calls

Flash

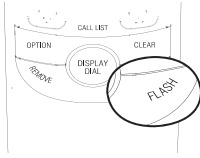

If you subscribe to call waiting service with your local telephone service provider, you hear a beep if someone calls while you are already on a call. Press **FLASH** on the handset to put your current call on hold and take the new call. You can press **FLASH** any time to switch back and forth between calls and to activate other telephone company subscriber services such as three-way calling. Contact your telephone company for information on subscriber services.

Mute

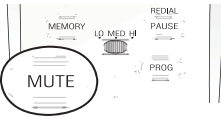

You can press and hold **MUTE** to silence the microphone during a conversation. You can hear the caller, but the caller does not hear you until you release **MUTE** to resume conversation.

Temporary tone dialing

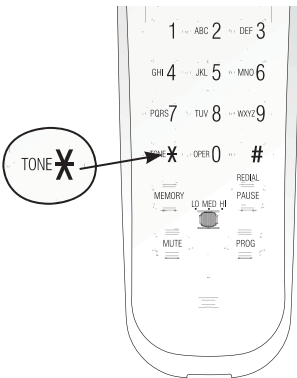

This feature can temporarily switch from dial-pulse to touch-tone dialing during a call.

1. Dial the number during a call.
2. Press **TONE***, and the phone will send touch-tone signals.
3. The telephone automatically returns to pulse dialing mode after you hang up.

Memory operation (one-touch)

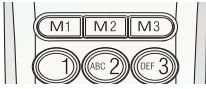

This telephone has 13 memory locations with three one-touch dialing location keys (**M1**, **M2**, **M3**), and 10 two-touch dialing location keys (**0** through **9**). Each location can hold a number up to 32 digits.

To store a number in one-touch

You can store three numbers in one-touch dialing location **M1**, **M2** or **M3**.

To store a number in one-touch:

1. Lift the handset and press **PROG**.
2. Use the dial pad keys (**0** through **9**, ***** and **#**) to enter the number you want to store. Press **PAUSE/REDIAL** once to store a 3-second pause in the dialing sequence, twice for a 6-second pause and so on.
- OR -
Press **PAUSE/REDIAL** to store the last number dialed.
3. Press a one-touch memory location (**M1**, **M2** or **M3**) where you want the number to be stored.

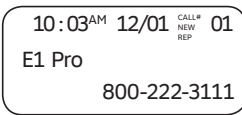
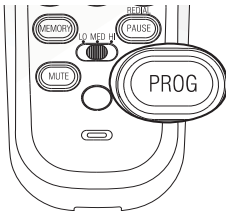

NOTES:

- When you store a new number in the one-touch location, the old entry will be replaced and cannot be retrieved.
- If no action is taken for 10 seconds, the telephone returns to idle mode automatically without saving your selection.

To review a number in one-touch

To review a number in the one-touch location, lift the handset and hold the switch hook on the handset, then press a one-touch key (**M1**, **M2** or **M3**). The number stored in the one-touch location is displayed on the screen.

To dial a number in one-touch

To dial a number in the one-touch location, lift the handset and then press a one-touch key (**M1**, **M2** or **M3**).

Memory operation (two-touch)

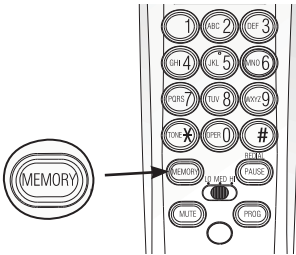
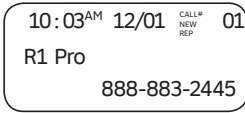

i NOTES:

- When you store a new number in the two-touch location, the old entry will be replaced and cannot be re-edited.
- If no action is taken for 10 seconds, the telephone returns to idle mode without saving your selection.



To store a number in two-touch

You can store 10 numbers in two-touch dialing location (0 through 9). Each location can hold a number up to 32 digits.

To store a number in two-touch:

1. Lift the handset and press **PROG**.
2. Use the dial pad keys (0 through 9, * and #) to enter the number you want to store. Press **PAUSE/REDIAL** once to add a 3 second pause in the dialing sequence.
- OR -
Press **PAUSE/REDIAL** to store the last number dialed.
3. Press **MEMORY**, then press the dial pad keys (0 through 9) where you want the number to be stored.

To review a number in two-touch

To review a number in the two-touch location, lift the handset and hold the switch hook on the handset, then press **MEMORY** and the dial pad keys (0 through 9). The number stored in the one-touch location is displayed on the screen.

To dial a number in two-touch

1. Lift the handset and press **MEMORY**.
2. Use the dial pad keys (0 through 9) where the destination number is stored.

Directory card

You may write the names or numbers stored in the telephone memory on the directory card.

Caller ID overview

About caller ID

This product supports caller ID services that most local telephone service companies provide. There is a fee for this service, and it might not be available in all areas. Caller ID with call waiting lets you see the name and telephone number of the caller before answering the telephone, even when on another call.

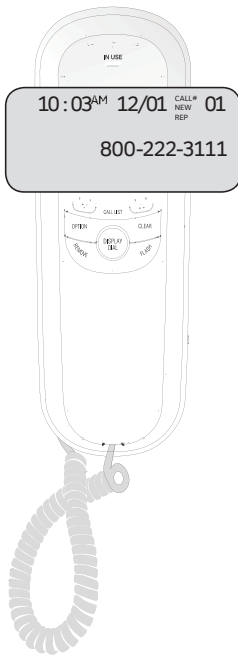

It may be necessary to change your telephone service to use this feature. Contact your telephone company if:

- You have both caller ID and call waiting, but as separate services (you may need combined service).
- You have only caller ID service, or only call waiting service.
- You do not have any caller ID or call waiting services.

This product can be used with regular caller ID service, or this product's other features can be used without subscribing to either caller ID or combined caller ID with call waiting service. There are fees for caller ID services, and they may not be available in all areas.

Depending on your service, you may see the caller's number or the caller's name and number. This product can provide information only if both you and the caller are in areas offering caller ID service and if both telephone companies use compatible equipment. The time and date are sent by the telephone company along with the call information.

Caller ID overview

How caller ID works

If you subscribe to caller ID service provided by your local telephone company, information about each caller appears between the first and second ring. If an incoming call is answered before the information appears on the screen, no information is stored or displayed.

This telephone deletes the earliest entry when the log is full to make room for new calls.

The caller log stores information about the last 80 incoming calls. You can review the call log to find out who has called, and to return the call without dialing.

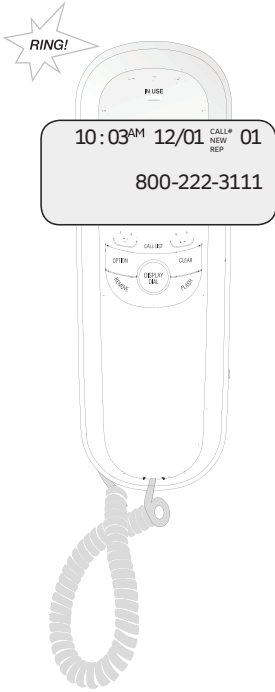

i NOTES:

- The caller's name (up to 16 characters) is sent by your local telephone company if you subscribe to caller ID/call waiting service.
- The area code of the caller's is not displayed if it is programmed as the home area code.

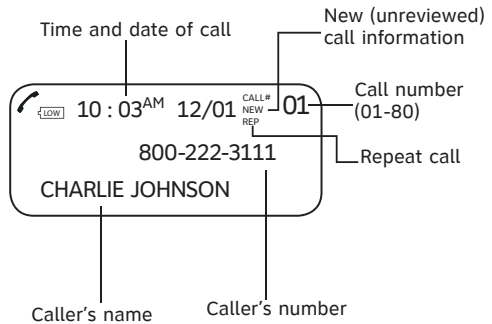

Caller ID overview

Caller ID special messages

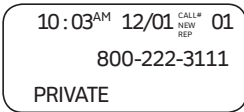

Screen display	Reason
PRIVATE	The caller is blocking the name information.
PPP	The caller is blocking the number information.
PRIVATE CALLER	The caller is blocking the name and number information.
UNKNOWN	Your telephone company is unable to receive this caller's name.
UUU	Your telephone company is unable to receive this caller's number.
UNKNOWN CALLER	Your telephone company is unable to receive this caller's name and number.
LONG DISTANCE	This is a long distance call and there is no information about this caller's name.

How call log works

A number (from 01 to 80) is assigned for each incoming call. The most recent call will have the highest number. If you receive more than one call from a particular telephone number, only the newest entry from that number will be saved. When the memory is full, the oldest call information is replaced by the new incoming call information.

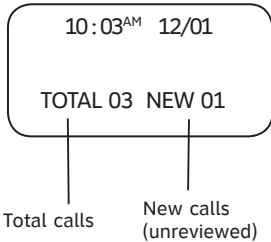

Reviewing the call log

To review the call log

The screen displays call information for about 10 seconds after it has been received.

This function can be accessed while the handset is lifted or on the base.

1. Press ▼ or ▲ to access the call list and display the latest caller ID entry.
2. Press ▼ repeatedly to scroll through the call list, which is in reverse chronological order (from the newest entry to the oldest entry), or press ▲ repeatedly to scroll through the call list in chronological order.
3. At the end of the call list, the screen displays **-END OF LIST-**.

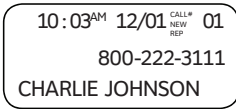

To dial the displayed number

To dial a number currently displayed in the call log, follow the steps below:

1. Press **DISPLAY DIAL**, the screen displays **LIFT RECEIVER**, then lift the handset.
2. The telephone dials the number automatically. If you do not lift the handset within 10 seconds after the screen displays **LIFT RECEIVER**, the telephone will return to idle mode.

- OR -

Press **CLEAR** twice to return to idle mode.

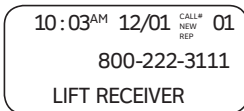
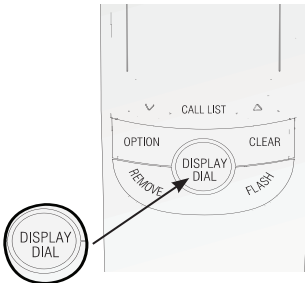

NOTE: If you have entered a home area code, telephone numbers from that area code may be displayed without the preceding **1**, but they will be dialed correctly.

10:03^{AM} 12/01 CALL*
NEW
REP 01
800-222-3111
CHARLIE JOHNSON

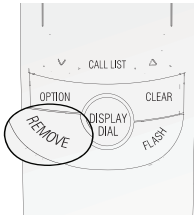

10:03^{AM} 12/01
REMOVE ALL?

10:03^{AM} 12/01
-END OF LIST-

Deleting call log entries

To delete a call log entry

Press ▼ or ▲ to display the call log. You can delete an entry or all entries in the call log by following the steps below.

To delete an entry

- When viewing call log entries, press **REMOVE** to delete the entry currently displayed.

- OR -

Press **CLEAR** to exit without deleting any entries and return to idle mode.

To delete all call log entries

1. Press and hold **REMOVE** when viewing the call log entries, the screen displays **REMOVE ALL?**
2. Press **REMOVE** again to delete all the entries, the screen displays **END OF LIST** and automatically returns to idle mode.

- OR -

Press **CLEAR** to exit without deleting any entries and return to idle mode.



NOTES:

- If there is no battery power for more than 10 minutes the call log information will be lost.
- When a caller ID entry is removed from the call log, it cannot be retrieved.

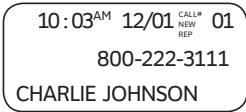

Copying a call log entry into memory

When you are reviewing call log entries, you can copy the displayed entry with up to 32 digits and 15 characters to a one-touch or two-touch memory location

1. Lift the handset.
2. Press ▼ or ▲ to display the call log.
3. Press **PROG** on the handset.
4. Press any one-touch location (**M1**, **M2**, or **M3**) where you want the number to be stored.
- OR -
Press **MEMORY**, then press any dial pad key (**0** through **9**) where you want the number to be stored.

NOTES:

- Press **CLEAR** on the back of the handset when you have finished storing a number in memory to exit programming.
- If you wait longer than 10 seconds to delete or copy the entry, the procedure will time-out and you have to begin again.
- If there is no battery power for more than 10 minutes, the call log information will be lost.

Troubleshooting

If you have difficulty with your telephone, please try the suggestions below. For Customer Service, visit our website at **www.telephones.att.com** or call **1 (800) 222-3111**. In Canada, dial **1 (866) 288-4268**.

- No dial tone.
- Ensure all plugs are connected properly and securely.
 - Inspect the telephone line cord connections at the wall jack and on the telephone.
 - Inspect the handset cord connections at both ends.
 - Unplug the telephone and connect it to another wall jack. If it still does not work, and the other telephones using the same jack are working, there is a problem with this telephone.

-
- Telephone does not ring.
- Ensure the **RINGER** switch on the side of the base unit is not set to **OFF**.
 - If there are other telephones on the same line, try disconnecting some of them. Having too many telephones connected can create problems such as low ringer volume or impaired sound quality during calls.

-
- Difficulty storing numbers in memory.
- Ensure you are pressing the correct sequence of buttons for storing numbers.
 - If you pause for over 10 seconds when programming an entry, the procedure will time-out and you will have to begin again.
 - Try calling the number to be stored in memory. When the call ends, press **PROG**, **PAUSE/REDIAL**, then a one-touch button (**M1**, **M2**, or **M3**), or **MEMORY** and a memory location (**0-9**).

-
- IN USE** light does not go on.
- Ensure four new AA batteries have been installed properly.

Troubleshooting

Screen is blank.

- Ensure the telephone handset cord is properly and securely connected to the handset and the telephone base.
 - Ensure four new AA batteries are installed properly (see **Battery installation** on page 5).
 - You must subscribe to caller ID service from your local telephone service provider to see call information on the screen (see **About caller ID** on 20).
-

Screen displays extension used, and none are

- Check to ensure all line cords are properly and securely connected.
-

My caller ID features are not working properly.

- Caller ID is a subscription service. You must subscribe to this service from your local telephone company for this feature to work on your telephone.
- The caller may not be calling from an area that supports caller ID. Both you and the caller's telephone companies must use equipment which are compatible with caller ID service.
- Ensure your service provides caller ID information when on a call. This is sometimes known as caller ID with call waiting, or type II caller ID.
- The telephone cannot display the information if another telephone on the same line is in use. Ensure all extensions are on hook.
- Ensure you have installed four new AA batteries properly (see **Battery installation** on page 5).
- If you subscribe to high-speed Internet service (digital subscriber line - DSL) through your telephone lines, you must install a DSL filter between the telephone line cord and the telephone wall jack. The filter prevents noise and caller ID problems caused by DSL interference. Please contact your DSL service provider for more information about DSL filters.

Maintenance

Taking care of your telephone

Your corded telephone contains sophisticated electronic parts, so it must be treated with care.

Avoid rough treatment

Place the handset down gently. Save the original packing materials to protect your telephone if you ever need to ship it.

Avoid water

Your telephone can be damaged if it gets wet. Do not use the handset outdoors in the rain, or handle it with wet hands. Do not install the telephone base near a sink, bathtub or shower.

Electrical storms

Electrical storms can sometimes cause power surges harmful to electronic equipment. For your own safety, take caution when using electrical appliances during storms.

Cleaning your telephone

Your telephone has a durable plastic casing that should retain its luster for many years. Clean it only with a soft cloth slightly dampened with water or a mild soap. Do not use excess water or cleaning solvents of any kind.

Remember that electrical appliances can cause serious injury if used when you are wet or standing in the water. If the telephone base should fall into the water, DO NOT RETRIEVE IT UNTIL YOU UNPLUG THE POWER CORD AND TELEPHONE LINE CORDS FROM THE WALL. Then pull the unit out by the unplugged cords.

Important product information



This symbol is to alert you to important operating or servicing instructions that may appear in this user's manual. Always follow basic safety precautions when using this product to reduce the risk of injury, fire, or electric shock.

Safety information

- **Read and understand all instructions in the user's manual. Observe all markings on the product.**
- **Avoid using a telephone during a thunderstorm.** There may be a slight chance of electric shock from lightning.
- **Do not use a telephone in the vicinity of a gas leak.** If you suspect a gas leak, report it immediately, but use a telephone away from the area where gas is leaking. If this product is a cordless model, make sure the base is also away from the area.
- **Do not use this product near water, or when you are wet.** For example, do not use it in a wet basement or shower, or next to a swimming pool, bathtub, kitchen sink, or laundry tub. Do not use liquids or aerosol sprays for cleaning. If the product comes in contact with any liquids, unplug any line or power cord immediately. Do not plug the product back in until it has dried thoroughly.
- **Install this product in a protected location** where no one can trip over any line. Protect cords from damage or abrasion.
- **If this product does not operate normally, read the Troubleshooting section on pages 26-27 of this user's manual.** If you cannot solve the problem, or if the product is damaged, refer to the **Limited warranty** section on pages 34-36. Do not open this product except as may be directed in your user's manual. Opening the product or reassembling it incorrectly may expose you to hazardous voltages or other risks.
- **If this product has a three-prong (grounding) plug or a polarized plug with one wide prong, it may not fit in non-polarized outlets.** Do not defeat the purpose of these plugs. If they do not fit in your outlet, the outlet should be replaced by an electrician.



CAUTION: Use only the power adapter provided with this product. To obtain a replacement, visit our website at **www.telephones.att.com** or call **1 (800) 222-3111**. In Canada, dial **1 (866) 288-4268**.

Important product information

Especially about corded telephones

- **Electrical power:** The telephone must be connected to a working electrical outlet. The electrical outlet should not be controlled by a wall switch. **Calls cannot be made if the telephone base is unplugged, switched off, or if the electrical power is interrupted.**
- **Power adapter:** This power adapter is intended to be plugged into a vertical wall outlet or a floor outlet. The prongs are not designed to hold the plug in place if it is plugged into a ceiling, under-the-table or cabinet outlet.

Especially about telephones answering systems

Two-way recording: This telephone does not sound warning beeps to let the other party know that the call is being recorded. To ensure that you are in compliance with any federal or state regulations regarding recording a telephone call, you should start the recording process and then inform the other party that you are recording the call.

SAVE THESE INSTRUCTIONS

FCC and ACTA information

If this equipment was approved for connection to the telephone network prior to July 23, 2001, it complies with Part 68 of the Federal Communications Commission (FCC) rules. If the equipment was approved after that date, it complies with the Part 68 rules and with Technical Requirements for Connection of Equipment to the Telephone Network adopted by the Administrative Council for Terminal Attachments (ACTA). We are required to provide you with the following information.

1. Product identifier and REN information

The label on the back or bottom of this equipment contains, among other things, an identifier indicating product approval and the Ringer Equivalence Number (REN). This information must be provided to your local telephone company upon request. For equipment approved prior to July 23, 2001, the product identifier is preceded by the phrase "FCC Reg No." and the REN is listed separately. For equipment approved after that date, the product identifier is preceded by "US" and a colon (:), and the REN is encoded in the product identifier without a decimal point as the sixth and seventh characters following the colon. For example, for product identifier US:AAAEQ03T123XYZ indicates the REN would be 0.3.

The REN is used to determine how many devices you may connect to your telephone line and still have them ring when you are called. In most, but not all areas, the sum of all RENS should be five (5.0) or less. You may want to contact your local telephone company for more information.

2. Connection and use with the nationwide telephone network

The plug and jack used to connect this equipment to the premises wiring and the telephone network must comply with the applicable part 68 rules and technical requirements adopted by ACTA. A compliant telephone cord and modular plug is provided with this product. It is designed to be connected to a compatible modular jack that is also compliant. An RJ11 jack should normally be used for connecting to a single line and an RJ14 jack for two lines, see installation instructions in the user's manual. This equipment may not be used with coin telephone lines or with party lines. If you have specially wired alarm dialing equipment connected to your telephone line, ensure the connection of this equipment does not disable your alarm equipment. If you have questions about what will disable the alarm equipment, consult your telephone company or qualified installer.

FCC and ACTA information

3. Repair instructions

If this equipment is malfunctioning, it must be unplugged from the modular jack until the problem has been corrected. Repairs to this telephone equipment can only be made by the manufacturer or its authorized agents. For repair procedures, follow the instructions outlined under the limited warranty.

4. Rights of the telephone company

If this equipment is causing harm to the telephone network, the telephone company may temporarily discontinue your telephone service. The telephone company is required to notify you before interrupting service. If advance notice is not practical, you will be notified as soon as possible. You will be given the opportunity to correct the problem and the telephone company is required to inform you of your right to file a complaint with the FCC. Your telephone company may make changes in its facilities, equipment, operation, or procedures that could affect the proper functioning of this product. The telephone company is required to notify you if such changes are planned.

5. Hearing aid compatibility

If this product is equipped with a corded or cordless handset, it is hearing aid compatible.

6. Programming/testing of emergency numbers

If this product has memory dialing locations, you may choose to store police, fire department and emergency medical service telephone numbers in these locations. If you do, please keep three things in mind:

- a. We recommend that you also write the telephone number on the directory card (if applicable), so that you can still dial the emergency number manually if the memory dialing feature doesn't work.
- b. This feature is provided only as a convenience, and the manufacturer assumes no responsibility for customer reliance upon the memory feature.
- c. Testing the emergency telephone numbers you have stored is not recommended. However, if you do make a call to an emergency number:
 - You must remain on the line and briefly explain the reason for the call before hanging up.
 - Programming/testing of emergency numbers should be performed during off-peak hours, such as in the early morning or late evening, when the emergency services tend to be less busy.

Part 15 of FCC rules

Some telephone equipment generates, uses, and can radiate radio-frequency energy and, if not installed and used properly, may cause interference to radio and television reception. This product has been tested and found to meet the standards for a class B digital device, as specified in part 15 of the FCC rules.

These specifications are designed to provide reasonable protection against such interference in a residential installation. However, there is no guarantee that interference will not occur in a particular installation.

If this product causes interference to radio, VCR or television reception when it is in use, you might correct the interference with any one or all of these measures:

- Where it can be done safely, re-orient the receiving radio, VCR or television antenna.
- To the extent possible, relocate the radio, VCR, television or other receiver with respect to the telephone equipment.
- If this telephone product runs on AC power, plug your product into an AC outlet that's not on the same circuit as one used by your radio, VCR or television.
- Consult a dealer or an experienced radio/TV technician for help.

Modifications to this product, not expressly approved by the manufacturer, could void the user's authority to operate the equipment.

Limited warranty

The AT&T brand is used under license - any repair, replacement or warranty service, and all questions about this product should be directed to: In the United States of America, visit our website at **www.telephones.att.com** or call **1 (800) 222-3111**. In Canada, please call **1 (866) 288-4268**.

1. What does this limited warranty cover?

The manufacturer of this AT&T-branded product warrants to the holder of a valid proof of purchase (“CONSUMER” or “you”) that the product and all accessories provided in the sales package (“PRODUCT”) are free from defects in material and workmanship, pursuant to the following terms and conditions, when installed and used normally and in accordance with the PRODUCT operating instructions. This limited warranty extends only to the CONSUMER for products purchased and used in the United States of America and Canada.

2. What will be done if the PRODUCT is not free from defects in materials and workmanship during the limited warranty period (“materially defective PRODUCT”)?

During the limited warranty period, the manufacturer’s authorized service representative will repair or replace at the manufacturer’s option, without charge, a materially defective PRODUCT. If the manufacturer repairs the PRODUCT, they may use new or refurbished replacement parts. If the manufacturer chooses to replace the PRODUCT, they may replace it with a new or refurbished PRODUCT of the same or similar design. The manufacturer will retain defective parts, modules, or equipment. Repair or replacement of the PRODUCT, at the manufacturer’s option, is your exclusive remedy. The manufacturer will return repaired or replacement products to you in working condition. You should expect the repair or replacement to take approximately 30 days.

3. How long is the limited warranty period?

The limited warranty period for the PRODUCT extends for ONE (1) YEAR from the date of purchase. If the manufacturer repairs or replaces a materially defective PRODUCT under the terms of this limited warranty, this limited warranty also applies to repaired or replacement PRODUCT for a period of either (a) 90 days from the date the repaired or replacement PRODUCT is shipped to you or (b) the time remaining on the original one-year limited warranty; whichever is longer.

Limited warranty

4. What is not covered by this limited warranty?

This limited warranty does not cover:

- PRODUCT that has been subjected to misuse, accident, shipping or other physical damage, improper installation, abnormal operation or handling, neglect, inundation, fire, water, or other liquid intrusion; or
- PRODUCT that has been damaged due to repair, alteration, or modification by anyone other than an authorized service representative of the manufacturer; or
- PRODUCT to the extent that the problem experienced is caused by signal conditions, network reliability or cable or antenna systems; or
- PRODUCT to the extent that the problem is caused by use with non-AT&T accessories; or
- PRODUCT whose warranty/quality stickers, PRODUCT serial number plates or electronic serial numbers have been removed, altered or rendered illegible; or
- PRODUCT purchased, used, serviced, or shipped for repair from outside the United States of America or Canada, or used for commercial or institutional purposes (including but not limited to products used for rental purposes); or
- PRODUCT returned without valid proof of purchase (see item 6 below); or
- Charges for installation or setup, adjustment of customer controls, and installation or repair of systems outside the telephone.

5. How do you get warranty service?

To obtain warranty service in the United States of America, visit **www.telephones.att.com** or call **1 (800) 222-3111**. In Canada, please dial **1 (866) 288-4268**. NOTE: Before calling for service, please review the user's manual - a check of the PRODUCT controls and features may save you a service call.

Except as provided by applicable law, you assume the risk of loss or damage during transit and transportation and are responsible for delivery or handling charges incurred in the transport of the PRODUCT(s) to the service location. The manufacturer will return repaired or replaced PRODUCT under this limited warranty. Transportation, delivery or handling charges are prepaid. The manufacturer assumes no risk for damage or loss of the PRODUCT in transit if the PRODUCT failure is not covered by this limited warranty, or proof of purchase does not meet the terms of this limited warranty, the manufacturer will notify you and will request that you authorize the cost of repair prior to any further repair activity. You must pay for the cost of repair and return shipping costs for the repair of products that are not covered by this limited warranty.

Limited warranty

6. What must you return with the PRODUCT to get warranty service?

You must:

- a. Return the entire original package and contents including the PRODUCT to the service location along with a description of the malfunction or difficulty; and
- b. Include “valid proof of purchase” (sales receipt) identifying the PRODUCT purchased (PRODUCT model) and the date of purchase or receipt; and
- c. Provide your name, complete and correct mailing address, and telephone number.

7. Other limitations

This warranty is the complete and exclusive agreement between you and the manufacturer of this AT&T branded PRODUCT. It supersedes all other written or oral communications related to this PRODUCT. The manufacturer provides no other warranties for this PRODUCT. The warranty exclusively describes all of the manufacturer’s responsibilities regarding the PRODUCT. There are no other express warranties. No one is authorized to make modifications to this limited warranty and you should not rely on any such modification.

State/Provincial Law Rights: This warranty gives you specific legal rights, and you may also have other rights which vary from state to state or province to province.

Limitations: Implied warranties, including those of fitness for a particular purpose and merchantability (an unwritten warranty that the PRODUCT is fit for ordinary use) are limited to one year from date of purchase. Some states/provinces do not allow limitations on how long an implied warranty lasts, so the above limitation may not apply to you. In no event shall the manufacturer be liable for any indirect, special, incidental, consequential, or similar damages (including, but not limited to lost profits or revenue, inability to use the PRODUCT or other associated equipment, the cost of substitute equipment, and claims by third parties) resulting from the use of this PRODUCT. Some states/provinces do not allow the exclusion or limitation of incidental or consequential damages, so the above limitation or exclusion may not apply to you.

Please retain your original sales receipt as proof of purchase.

Technical specifications

Operation temperature	32°F -122°F 0°C - 50°C
REN (Ringer Equivalence Number)	0.7B

Index

A

Adjust ringer volume, 16
Answer a call, 16

B

Battery installation, 5

C

Caller ID, 20
Call waiting, 14

D

Delete call log entries, 24
Dialing the displayed number, 23

F

FCC, 31–33

H

Handset layout, 2
Handset volume, 16
Home area code, 11

L

Language, 15
Last number redial, 16

M

Maintenance, 28
Make a call, 16
Mute, 17

O

One-touch, 18

R

Redial, 16
Reviewing the call log, 23
Ringer volume, 16

T

Tabletop installation, 8
Technical specifications, 37
Temporary tone dialing, 17
Tone/pulse, 15
Troubleshooting, 26–27
Two-touch, 19

V

Volume, 16

W

Wall installation, 7



www.telephones.att.com