



at&t

User's manual

**TL7600**

**DECT 6.0 expansion headset**

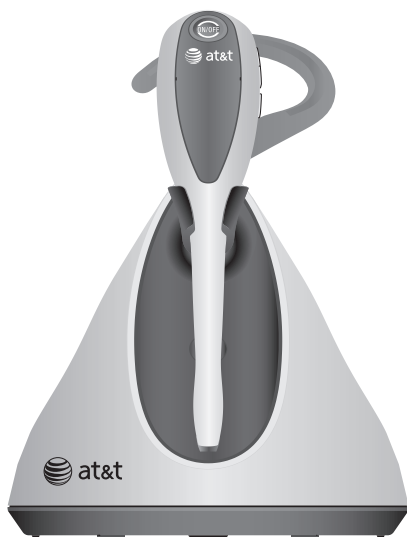

# Congratulations

on your purchase  
of this AT&T product.

Before using this AT&T product, please read the  
**Important safety information**

on pages 39-42 of this manual. Please thoroughly  
read the user's manual for all the feature operations  
and troubleshooting information necessary to install  
and operate your new AT&T product. You can also  
visit our website at **www.telephones.att.com**  
or call **1 (800) 222-3111**.

In Canada, dial **1 (866) 288-4268**.

Model #: TL7600

Type: DECT 6.0 expansion headset

Serial #: \_\_\_\_\_  
(found on the bottom of the headset charger)

Purchase date: \_\_\_\_\_

Place of purchase: \_\_\_\_\_

Save your sales receipt and original packaging in case it is necessary  
to return your telephone for warranty service.

© 2008 Advanced American Telephones. All rights reserved.

AT&T and the AT&T logo are trademarks of AT&T Intellectual Property II, L.P. d/b/a  
AT&T Intellectual Property licensed to Advanced American Telephones, San  
Antonio, TX 78219.

Printed in China.

# Parts checklist

Check to make sure the headset package includes the following items:

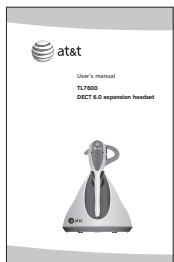

User's manual



Cordless headset

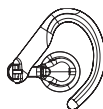

Over-the-ear hook

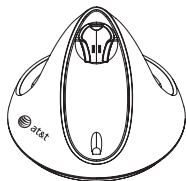

Headset charger



Battery compartment cover



Battery for headset



Charger power adapter



Behind-the-neckband



Over-the-headband

# User's manual

## TL7600

### DECT 6.0 expansion headset



## Table of contents

### Getting started

Installation preparation.....	1
Charger installation.....	2
Battery installation.....	3
Battery charging.....	4
Registering the headset.....	5
To register a headset to the DECT headset base.....	6
To register the headset to an AT&T DECT cordless telephone base.....	7
Quick reference guide .....	8
Headset attachments	
Over-the-ear hook.....	9
Over-the-headband .....	12
Behind-the-neckband.....	14

### Operation

Headset operation	
Making a call.....	17
Answering a call on the headset.....	18

Ending a call on the headset.....	18
Auto off .....	18
Temporary ring tone silencing .....	19
Intercom and intercom call transfer.....	19
Options while on calls	
Volume control.....	20
Call waiting.....	20
Switching a call between handset and headset.....	21
Multiple headset/handset use.....	22
Mute .....	22
Alert tones.....	23
Indicator lights.....	24

## Table of contents

### **De-registration**

Replacing a headset .....25

To de-register all headsets  
from the headset base ...25

To de-register all headset(s)  
from an AT&T cordless  
telephone base.....26

## Installation preparation

You must install and charge the battery before using the headset.



See pages 3-4 for easy instructions.

If you subscribe to high-speed Internet service (digital subscriber line - DSL) through your telephone lines, you must install a DSL filter between the telephone line cord and the telephone wall jack. The filter prevents noise and caller ID problems caused by DSL interference. Please contact your DSL service provider for more information about DSL filters.

For customer service or product information, visit our website at **[www.telephones.att.com](http://www.telephones.att.com)** or call **1 (800) 222-3111**. In Canada, dial **1 (866) 288-4268**.

### **Avoid placing the headset charger too close to:**

- Communication devices such as: television sets, VCRs, or other cordless telephones.
- Excessive heat sources.
- Noise sources such as a window with traffic outside, motors, microwave ovens, refrigerators, or fluorescent lighting.
- Excessive dust sources such as a workshop or garage.
- Excessive moisture.
- Extremely low temperature.
- Mechanical vibration or shock such as on top of the washing machine or work bench.

## Charger installation

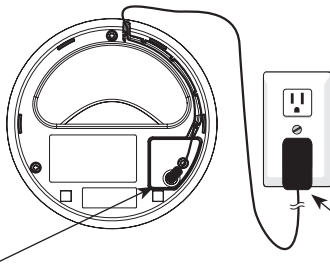

1. Plug the small end of the charger power adapter into the jack on the underside of the charger, then route the cord through the slot as shown.
2. Plug the large end of the charger power adapter into a power outlet not controlled by a wall switch.

### IMPORTANT INFORMATION

1. Use only the power adapter supplied with this product. To order a replacement power adapter, visit our website at **[www.telephones.att.com](http://www.telephones.att.com)**, or call **1 (800) 222-3111**. In Canada, dial **1 (866) 288-4268**.
2. The power adapter is intended to be correctly oriented in a vertical or floor mount position. The prongs are not designed to hold the plug in place if it is plugged into a ceiling, under-the-table or cabinet outlet.

## Battery installation

Install the battery as shown below. For optimal performance, charge the headset battery for at least six hours before use. When not in use, recharge the headset by returning it to the headset charger.

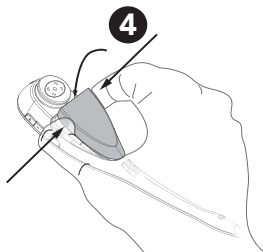
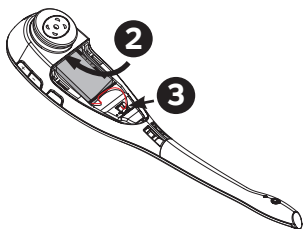
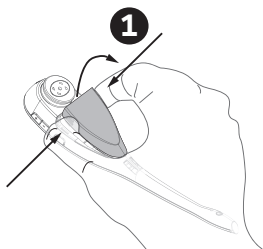

1. If the battery door is attached, press on both sides of the battery compartment cover and lift the cover up and off.
2. Insert the battery into the battery compartment with the label **THIS SIDE UP** facing up.
3. Push the battery plug into the connector inside the compartment according to the color-coded label and place the wires neatly inside the compartment.
4. Insert the tab on the bottom of the battery cover into the battery compartment. Press down gently on the battery cover until it snaps into place.



**NOTE:** Remove the ear hook from the headset (see page 11) before battery replacement.



## Battery charging

After installing the battery, charge the headset by placing it in the headset charger as shown below. Before registration, the headset **ON/OFF** light flashes twice every five seconds whether the headset is charging or not. After registration, the headset **ON/OFF** light is on when the headset is charging.

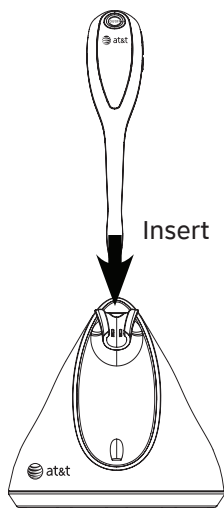

1. Insert the headset into the charging cradle.

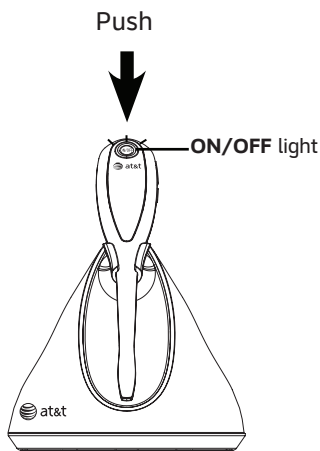

2. Push the headset downward until the **ON/OFF** light on the headset turns on.

### IMPORTANT INFORMATION

Use only the supplied rechargeable battery or replacement battery (model BT191545). To obtain a replacement battery, visit our website at **[www.telephones.att.com](http://www.telephones.att.com)** or call **1 (800) 222-3111**. In Canada, dial **1 (866) 288-4268**.

## Registering the headset

You must register your new TL7600 headset with one of the following models before use:

- AT&T DECT cordless headset TL7610/TL7611 (see page 6).

You can register a maximum of two headsets to each headset base.

### **-OR-**

- A compatible AT&T DECT cordless telephone (see page 7).  
You can register a maximum of two headsets to each cordless telephone.

The telephone base recognizes and counts a headset the same as a handset. Refer to your telephone user's manual for the maximum number of handsets that you can register to the telephone base. If you have the maximum number of handsets registered, you need to follow the de-registration information in your telephone user's manual.

Visit **[www.telephones.att.com](http://www.telephones.att.com)** for a list of compatible telephones.

The first headset provided with your TL7610/TL7611 has a blue **ON/OFF** light. When you register a second headset, the **ON/OFF** light of the headset turns orange to help you identify the headsets.

You can only register the headset to one product at a time, so the headset must be unregistered before registering to a headset base or a cordless phone.



**NOTE:** See pages 25 and 26 for instructions on de-registering.

## Registering the headset

### To register a headset to the DECT headset base:

---

1. Make sure the battery is properly installed in the headset (see page 3). The **ON/OFF** light flashes twice every five seconds to indicate the headset is not registered.
2. Place the headset in the headset charger and allow it to charge for at least five minutes before beginning registration. Remove the headset from the charger and replace the headset back into the charger.
3. On the headset base, press and hold the **PAIR** button until the **MUTE** light on the headset base turns on (about four seconds) and release the button.

Registration may take about 30 seconds to complete. The **MUTE** light on the headset base turns off. The headset **ON/OFF** light turns blue on the first headset registered. The headset **ON/OFF** light turns orange on the second headset registered.

To verify registration was successful, press the headset **ON/OFF** button and check for a dial tone.

If the registration is not successful, the **ON/OFF** light on the headset flashes twice every five seconds. To reset the headset, remove the headset from the headset charger and try the registration process again.

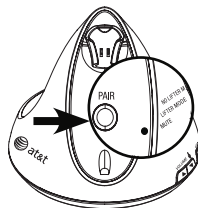
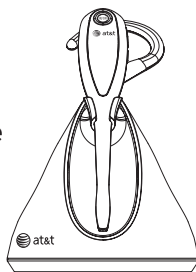

## Registering the headset

### To register the headset to an AT&T DECT cordless telephone base:

---

1. Make sure the battery is properly installed in the headset (see page 3). The **ON/OFF** light flashes twice every five seconds to indicate the headset is not registered.
2. Place the headset in the headset charger and allow it to charge for at least five minutes before beginning registration. Remove the headset from the charger and replace the headset back into the charger.
3. On the telephone base of the cordless phone, press and hold the  **HANDSET LOCATOR** button until the **IN USE** light comes on (about four seconds) and release the button.
4. The headset registers to the telephone base automatically; this may take about 30 seconds to complete. The **IN USE** light on the telephone base turns off. The headset **ON/OFF** light turns blue on the first headset registered. The headset **ON/OFF** light turns orange on the second headset registered. To verify registration was successful, press the headset **ON/OFF** button and check for a dial tone.



**NOTE:** If the registration is not successful, the **ON/OFF** light on the headset flashes twice every five seconds. Reset the headset and try again. Remove the headset from the charger and press **ON/OFF**. Then place the headset back into the headset charger. Try the registration process again.

## Quick reference guide

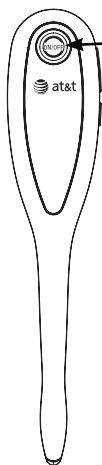

### **ON/OFF**

Press to make and/or answer a call, and to end a call.

The light is on when the headset is charging in the headset base or charger.

The light flashes slowly when you are on a call or flashes quickly when there is an incoming call (page 24).

### **VOLUME** + -

Press the volume key on the side of the headset to adjust the listening volume when on a call.

### **MUTE/FLASH**

Press to mute the microphone during a call (page 22).

Press and hold to receive call waiting during a call (page 20).

Press to mute the ring tone in the earpiece when there is an incoming call.

### **Battery cover**

Open to install or replace the battery.

### **Microphone**

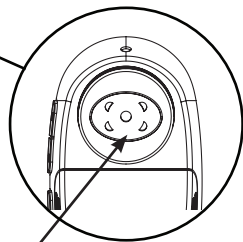

### **EARPIECE**

## Headset attachments

### Over-the-ear hook

---

To attach the ear hook to the headset:

1. Remove any headset attachment connected to the headset.
2. Insert the earpiece into the ear hook as shown in Figure 1.
3. Press the ear hook onto the earpiece as shown in Figure 2.
4. Hook the headset onto the desired ear. Adjust the angle of the headset until the microphone is pointing towards your mouth as shown in Figure 3.

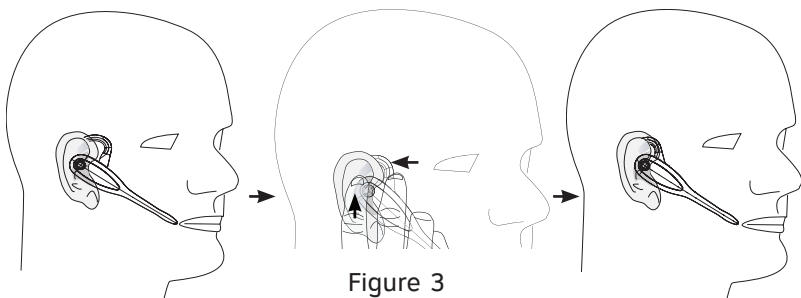
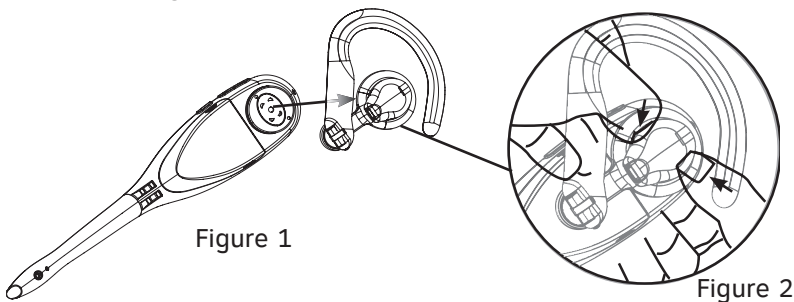

**NOTE:** Firmly grip the earpiece with one hand whenever adjusting the headset microphone up or down (Figure 3).

## Headset attachments

### Over-the-ear hook

---

To adjust the headset to wear on the left or right ear:

1. Hold the headset in your hand. Lift the hook upward as shown in Figure 1.
2. Twist the hook 180° (counterclockwise) as shown in Figure 2.
3. Push the hook downward as shown in Figure 3.
4. Hook the headset onto the desired ear. Adjust the angle of the headset until the microphone is pointing towards your mouth as shown in Figure 4.

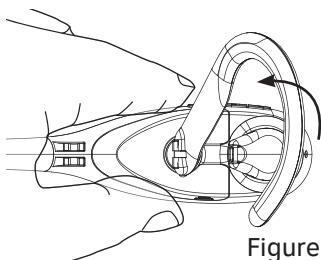

Figure 1

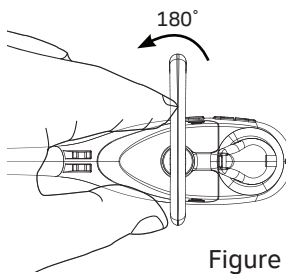

Figure 2

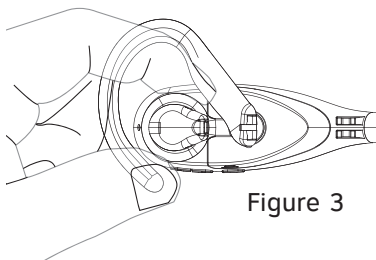

Figure 3

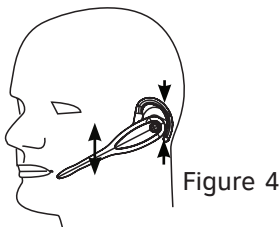

Figure 4

## Headset attachments

### **Over-the-ear hook**

---

To remove the ear hook from the headset:

Hold the headset with one hand and the ear hook with the other hand. Lift the ear hook up until it separates from the earpiece.

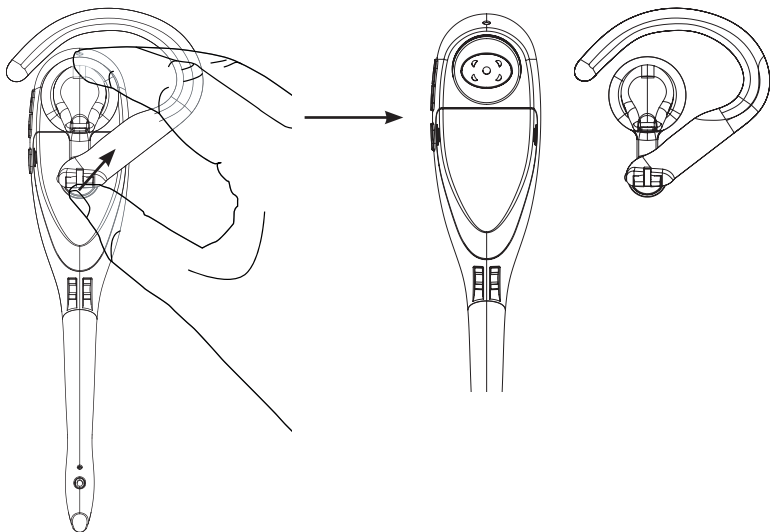



## Headset attachments

### Over-the-headband

---

To attach the headset to the headband for wearing on the left or right ear:

1. Remove any headset attachment currently connected to the headset.
2. Insert the earpiece into the headband ring as shown in Figure 1.
3. Push the earpiece towards the headband ring until it clicks into place as shown in Figure 2.
4. Adjust the headband to fit your head. Adjust and rotate the angle of the headset until the microphone is pointing toward your mouth as shown in Figure 3.

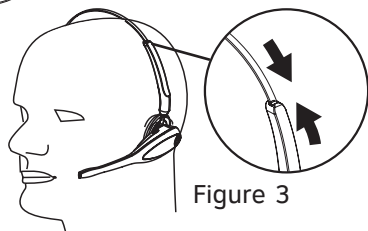
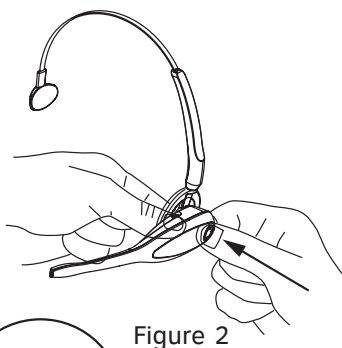
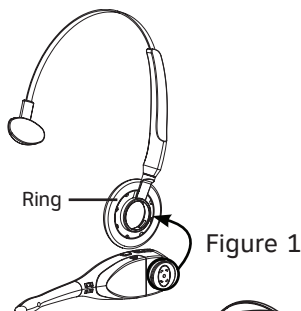

#### NOTES:

1. To wear on the other ear, rotate the headset within the headband ring.
2. Firmly grip the padded earpiece with one hand whenever adjusting the headset microphone up or down (Figure 3).

## Headset attachments

### **Over-the-headband**

---

To remove the headset from the headband:

Hold the headset with one hand and the headband ring with the other hand. Twist and pull the headset until it separates from the ring of the headband.

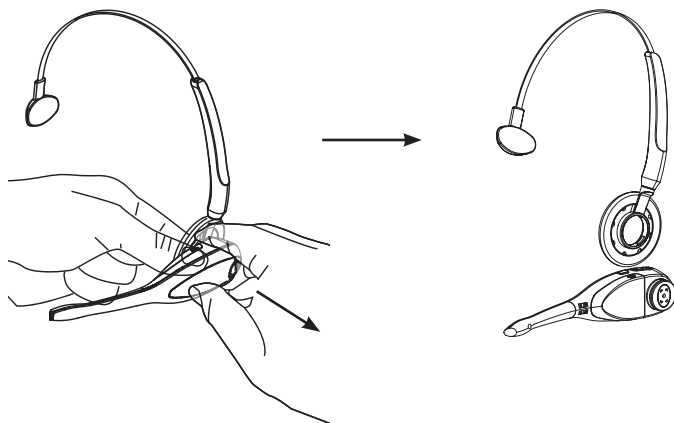

## Headset attachments

### **Behind-the-neckband**

---

The neckband ring is positioned for right-ear wearing when shipped.

To wear the headset on your left ear:

1. Remove the ring from the neckband. Note the small opening in the plastic at the place where the ring meets the neckband. Then rotate the ring post up and through that small opening, as shown in Figure 1.

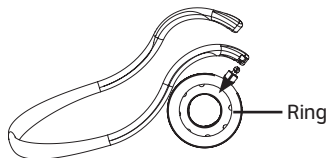

Figure 1

2. Snap the ring into the small socket at the end of the left arm of the neckband

To attach the headset to the neckband for wearing on the left or right ear:

1. Remove any headset attachment currently connected to the headset.
2. Insert the earpiece into the neckband ring as shown in Figure 2.

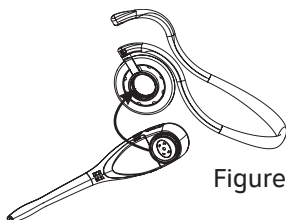

Figure 2

## Headset attachments

### Behind-the-neckband

---

3. Push the earpiece towards the neckband ring until it clicks into place as shown in Figure 3.
4. Place the neckband around your neck and over your ears.
5. Adjust and rotate the angle of the headset until the microphone is pointing toward your mouth as shown in Figure 4.

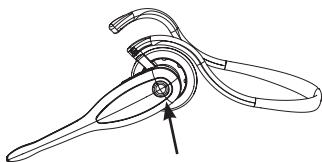

Figure 3

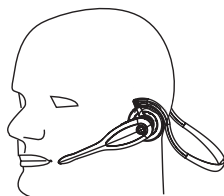

Figure 4



**NOTE:** Firmly grip the padded earpiece with one hand whenever adjusting the headset microphone up or down (Figure 4).

## Headset attachments

### **Behind-the-neckband**

---

To remove the headset from the ring of the neckband:

Hold the headset with one hand and the neckband ring with the other hand. Twist and pull the headset until it separates from the ring of the neckband.

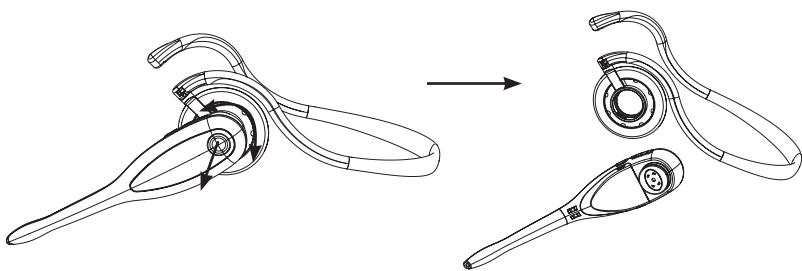

## Headset operation

### **Making a call**

---

If you registered the expansion headset to a headset base, see the user's manual for your headset base model TL7610/TL7611 for additional instructions. Visit **[www.telephones.att.com](http://www.telephones.att.com)** to view or download the user manuals.

### **If you registered the expansion headset to an AT&T DECT cordless telephone:**

1. Follow the instructions in your telephone user's manual for making calls.
2. To switch to the headset, press **ON/OFF** on the headset at any time.
3. After you switch the call to the headset, you can hang up the telephone and continue the call on the headset.

## Headset operation

### **Answering a call on the headset**

---

Press **ON/OFF** on the headset.

### **Ending a call on the headset**

---

Press **ON/OFF** on the headset.

### **Auto off**

---

A call ends automatically when you put the headset in the headset charger.



**NOTE:** The headset does not have an external ringer. When you receive calls, the headset earpiece plays a ring tone.

## Headset operation

### **Temporary ring tone silencing**

---

Press **MUTE/FLASH** to temporarily silence the ring tone in the headset earpiece. This silences the ring tone without disconnecting the call. The next incoming call rings normally at the preset volume.



**NOTE:** If you have more than one headset registered to the headset base, both headsets receive the ring tone when there is an incoming call. Pressing **MUTE/FLASH** on one headset will only silence the ring tone of that particular headset.

### **Intercom and intercom call transfer**

---

If you have registered your headset to an AT&T DECT cordless telephone, follow the instructions in your telephone user's manual for intercom and intercom call transfer.

When the cordless handset prompts you to enter a handset number:

- If you have one registered handset, press **#** on the cordless handset.
- If you have two registered handsets, press **#1** for handset 1 and **#2** for handset 2.



**NOTE:** You can only intercom or intercom call transfer from an AT&T DECT cordless handset to the DECT cordless headset.



## Options while on calls

### Volume control

---

#### To adjust the listening volume:

While on a call, press the **VOLUME**  + - keys on the side of the headset to adjust the listening volume.



**NOTE:** When the volume reaches the minimum or maximum setting, you hear three quick beeps.

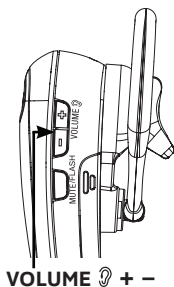

**VOLUME**  + -

### Call waiting

---

If you subscribe to call waiting service offered by your telephone service provider, you hear a beep if there is an incoming call while you are already on a call.

- If you have registered the TL7600 to a headset base and chosen installation option 3 from the TL7610/TL7611 user's manual, you must answer call waiting using the corded telephone base (see your telephone user's manual for instructions).

To end call waiting call, press **ON/OFF** on the headset and hang up the corded handset by placing it in the telephone base.

- For all other installations, press and hold **MUTE/FLASH** on the side of the headset to put your current call on hold and answer the new call. You can press and hold **MUTE/FLASH** at any time to switch back and forth between calls.

To end call waiting call, press **ON/OFF** on the headset.

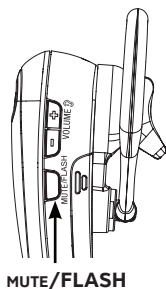

**MUTE/FLASH**

## Options while on calls

### **Switching a call between handset and headset**

#### **If you have registered the TL7600 to a TL7610/TL7611 headset base that is plugged into the telephone wall jack (installation option 1 or 2):**

- To switch from the corded handset to a headset while on a call, press **ON/OFF** on the headset, then place the corded handset back into the telephone base.
- To switch from a headset to the corded handset while on call, lift the corded handset from the telephone base, then press **ON/OFF** on the headset.
- To switch from a cordless handset to a headset while on a call, press **ON/OFF** on the headset, then hang up the cordless handset.
- To switch from a headset to a cordless handset while on a call, press the button you use to answer a call, then press **ON/OFF** on the headset.

#### **If you have registered the TL7600 to a TL7610/TL7611 headset base that is connected to a multiple line or digital business corded telephone (installation option 3):**

To switch between a headset and the corded handset while on a call, press **ON/OFF** on the headset.



**NOTE:** For information about installation options 1, 2, and 3, see the user's manual for your headset base model TL7610/TL7611. Visit **[www.telephones.att.com](http://www.telephones.att.com)** to view or download the user manuals.

## Options while on calls

### **Multiple headset/handset use**

---

Headset(s) and handset(s) on the same phone line can join an external call in progress. The number of headset(s) and handset(s) that can join may be limited by your telephone system. See your telephone user's manual for more information.

Join a call with a headset by pressing **ON/OFF** on the headset. To hang up, press **ON/OFF** or place the headset in the headset charger.

### **Mute**

---

The mute function allows you to turn off the headset microphone. You can hear the caller, but the caller is not able to hear you.

To mute the call:

- Press **MUTE/FLASH** on the headset to turn off the headset microphone. When mute is on, there is a short beep every 15 seconds until mute is turned off.

To un-mute the call:

- Press **MUTE/FLASH** on the headset again and resume speaking.

## Alert tones

### Alert tones

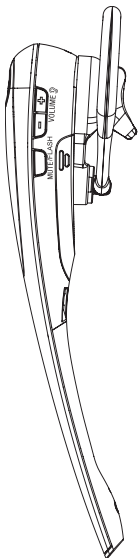

Headset alert tones	
Three quick beeps.	<ul style="list-style-type: none"> <li>• <b>VOLUME</b>  + – keys are pressed when the volume is already at its highest or lowest setting.</li> <li>• The headset is not registered and the headset <b>ON/OFF</b> button was pressed.</li> <li>• The headset has gone out of range from the headset base during a call.</li> </ul>
1 short beep every 20 seconds.	Low battery warning.
1 short beep every 15 seconds.	The call is muted.
1 long beep repeated.	Call waiting alert tone.
1 short beep.	When the headset <b>ON/OFF</b> key is pressed to go on-hook or off-hook.

## Indicator lights

### Indicator lights



**ON/OFF light**

- Blue light for headset 1.
- Orange light for headset 2.

<b>ON/OFF light status</b>	
On	<ul style="list-style-type: none"> <li>• Headset is charging in the headset charger.</li> <li>• Headset is trying to register to the headset base or telephone base.</li> <li>• Headset is searching for the headset base.</li> </ul>
Flash	<ul style="list-style-type: none"> <li>• Flashes slowly when incorrect battery is installed.</li> <li>• Flashes three times, followed by a pause, then repeats this cycle three more times and then shuts down to indicate the battery level is very low.</li> <li>• Flashes twice every five seconds to indicate the headset is not registered.</li> <li>• Flashes every 20 seconds to indicate the battery is low and needs to be charged in the headset charger.</li> <li>• Flashes every three seconds to indicate the headset is in use.</li> <li>• Flashes quickly when there is an incoming call.</li> </ul>

## Replacing a headset

### **You may need to de-register your headsets if:**

You have two registered headsets and need to replace one of them.

### **-OR-**

You wish to change the designated headset number and/or the color of the **ON/OFF** light of your registered headsets.

You must first de-register both headsets, and then re-register each headset you wish to use.

**Please read carefully through all the instructions before beginning the de-registration process.**

### **To de-register all headsets from the headset base**

---

This procedure de-registers all the items registered to the headset base.

1. Press and hold **PAIR** on the headset base until the **MUTE** light on the headset base turns on and starts to flash (at least 10 seconds), then release the **PAIR** button.
2. Immediately press and release **PAIR** again. You must press **PAIR** while the **MUTE** light is still flashing. (The light flashes for about seven seconds. If the light stops flashing, start again with step one above.)
3. If de-registration was successful:
  - The **MUTE** light on the headset base turns off.
  - The headset(s) **ON/OFF** light flashes twice every five seconds.
4. To re-register the headset(s) to the headset base, follow the registration instructions on page 6.

## Replacing a headset

### To de-register all headsets from the headset base

---







#### NOTES:

1. If the de-registration process was not successful, you may need to reset the system and try again. Remove the headset from the headset base and press **ON/OFF**. Place the headset back into the headset base. You may also reset by unplugging the power from the headset base, then wait a few seconds, and plug it back in.
2. You cannot de-register the headset(s) if another system headset is in use.

### To de-register all headset(s) from an AT&T cordless telephone base

---

This procedure de-registers all the headset(s) and handset(s) registered to the cordless phone.

1. Press and hold  **HANDSET LOCATOR** on the telephone base of the cordless phone until the **IN USE** light on the telephone base turns on and starts to flash (at least 10 seconds), then release the  **HANDSET LOCATOR** button.
2. Immediately press and release  **HANDSET LOCATOR** again. You must press  **HANDSET LOCATOR** while the **IN USE** light is still flashing. (The light flashes for about seven seconds. If the light stops flashing, start again with step one above.)
3. De-registration may take up to 10 seconds to complete. The **ON/OFF** light on the headset flashes twice every five seconds if de-registration was successful.



#### NOTES:

1. See your telephone user's manual to re-register the handsets.
2. See page 7 of this manual to re-register a headset.

## Troubleshooting

If you have difficulty with your headset, please try the suggestions below. For Customer Service, visit our website at **[www.telephones.att.com](http://www.telephones.att.com)**, or call **1 (800) 222-3111**. In Canada, dial **1 (866) 288-4268**.

My headset doesn't work at all.

- Make sure the power cord is securely plugged in.
- Make sure the battery connector is securely plugged into the cordless headset.
- Make sure the telephone line cord is securely and firmly plugged into the headset or telephone base and the telephone wall jack.
- Charge the battery in the cordless headset for at least 6 hours. For optimum daily performance, return the cordless headset to its charger when not in use.
- Reset the headset base or charger. Unplug the unit's electrical power. Wait for approximately 15 seconds, then plug it back in. Allow up to one minute for the cordless headset and headset base or charger to reset.
- You may need a new battery. Please refer to page 4 of this user's manual.

---

I cannot get a dial tone.

- First, try all the suggestions above.
- Move the cordless headset closer to the headset or telephone base. You might have moved out of range.



## Troubleshooting

- If the previous suggestions do not work, disconnect the headset or telephone base from the telephone jack and connect a different phone. If there is no dial tone on that phone either, the problem is in your wiring or local service. Contact your local telephone company.
  - Your telephone line cord might be malfunctioning. Try installing a new telephone line cord.
- 

I am getting a buzzing sound on my headset or corded base speakerphone.

- Your telephone may experience interference from the headset. To overcome this problem, move the headset base at least 12 inches away from the telephone.
- Other electronic products can cause interference to your cordless headset. Try installing your headset as far away from these types of electronic devices as possible: television sets, VCRs, or other cordless telephones.

## Troubleshooting

I cannot dial out.

- First try all the suggestions above.
- Make sure you have a dial tone before dialing. The cordless headset may take a second or two to find the headset or telephone base and produce a dial tone. This is normal. Wait an extra second before dialing.
- Eliminate any background noise. Noise from a television, radio or other appliances may cause the headset to not dial out properly. If you cannot eliminate the background noise, try dialing from another room with less background noise.
- If the other phones in your home are having the same problem, the problem is in your wiring or local service. Contact your local telephone company (charges may apply).

---

The other party cannot hear my voice during a call.

- If you registered the expansion headset to a headset base, try adjusting the speaking volume setting on the headset base. See the volume section of the user's manual for your headset base model TL7610/TL7611 for additional troubleshooting. Visit **[www.telephones.att.com](http://www.telephones.att.com)** to view or download the user manuals.

## Troubleshooting

My cordless headset isn't performing normally.

- Make sure the power cord is securely plugged into the headset base or charger. Plug the unit into a different, working electrical outlet not controlled by a wall switch.
- Move the cordless headset closer to the headset or telephone base. You might have moved out of range.
- Reset the headset base or charger. Unplug the unit's electrical power. Wait for 15 seconds, then plug it back in. Allow up to one minute for the cordless headset and headset base or charger to reset.
- Other electronic products can cause interference to your cordless headset. Try installing your headset as far away from these types of electronic devices as possible: television sets, VCRs, or other cordless telephones.

---

I want to use my headset with a different headset base or cordless telephone.

- You need to de-register (see page 25) the headset from the current headset or telephone base and then register (see page 5) it to a new headset base or cordless telephone.

## Troubleshooting

The batteries do not hold a charge.

- Make sure that the headset battery is installed and securely plugged into the connector.
- If the cordless headset is in the headset base or charger and the **ON/OFF** light on the headset does not come on, refer to **The ON/OFF light on the headset is off while charging** in this **Troubleshooting** guide.
- Charge the battery in the cordless headset for at least 6 hours. For optimum daily performance, return the cordless headset to the headset or charger when not in use.
- You may need a new battery. Please refer to the **Battery charging** section on page 4.
- Your headset might be malfunctioning. Please refer to the **Limited warranty** section on page 49 for further instructions.

## Troubleshooting

I get noise, static, or weak signal even when I'm near the headset or telephone base.

- If you subscribe to high-speed Internet service (digital subscriber line - DSL) through your telephone lines, you must install a DSL filter between the telephone line cord and the telephone wall jack. The filter prevents noise and caller ID problems caused by DSL interference. Please contact your DSL service provider for more information about DSL filters.
- You may be able to improve the performance of your cordless headset by installing your new headset base farther from any other existing cordless telephone system.
- Other electronic products can cause interference to your cordless phone. Try installing your phone as far away from the following electronic devices as possible: television sets, VCRs, or other cordless telephones.
- Do not install this headset near a microwave oven or on the same electrical outlet. You may experience decreased performance while the microwave oven is operating.
- If your headset is plugged in with a modem or a surge protector, plug the headset (or modem/surge protector) into a different location. If this doesn't solve the problem, re-locate your headset or modem farther apart from one another, or use a different surge protector.

## Troubleshooting

- Relocate your headset or telephone base to a higher location. You may experience better reception by elevating the headset or telephone base.
- If the other phones in your home are having the same problem, the problem is in your wiring or local service. Contact your local telephone company (charges may apply).

---

I hear other calls while using my headset.

- Disconnect the headset or telephone base from the telephone jack, and plug in a different telephone. If you still hear other calls, the problem is probably in your building's wiring or local service. Call your local telephone company.

---

I cannot hear a ring tone from the headset when there is an incoming call.

- If you have pressed **MUTE/FLASH** on the headset when it is ringing, it mutes the ring tone of the headset. The ring tone resumes on the next call.
- You may have too many extension phones on your telephone line to allow all of them to ring simultaneously. Try unplugging some of the other phones.
- The layout of your home or office might be limiting the operating range. Try moving the headset or telephone base to another location, preferably on an upper floor.

## Troubleshooting

- Test a working phone at the phone jack. If another phone has the same problem, the problem is the phone jack, wiring or service. Contact your local telephone company (charges may apply).
- Other electronic products can cause interference with your cordless headset. Try installing your headset as far away as possible from electronic devices such as television sets, VCRs, or other cordless telephones.
- Re-install the battery, and place the cordless headset in the headset base or charger. Wait for the cordless headset to re-establish its connection with the headset or telephone base. Allow up to one minute for this to take place.
- Your telephone line cord might be malfunctioning. Try installing a new telephone line cord.

## Troubleshooting

My calls cut in and out while I'm using my cordless headset.

- Other electronic products can cause interference with your cordless headset. Try installing your headset as far away from the following electronic devices as possible: television sets, VCRs, or other cordless telephones.
- Do not install this headset near a microwave oven or on the same electrical outlet. You may experience decreased performance while the microwave oven is operating.
- If your headset is plugged in with a modem or surge protector, plug the headset (or modem/surge protector) into a different location. If this doesn't solve the problem, relocate your headset or modem farther apart from one another, or use a different surge protector.
- Relocate your headset or telephone base to a higher location. You may experience better reception by elevating the base.
- If the other phones in your home are having the same problem, the problem is in your wiring or local service. Contact your local telephone company (charges may apply).



## Troubleshooting

The **ON/OFF** light on the headset is off while charging.

- Make sure the power and line cords are plugged in correctly and securely.
- Make sure that the battery connector is securely plugged into the cordless headset.
- Push the headset downwards in the charging cradle until the **ON/OFF** light on the headset turns on.
- Unplug the unit's electrical power. Wait for 15 seconds, then plug it back in. Allow up to one minute for the cordless headset and headset base or charger to reset.
- Clean the cordless headset and headset base or charger charging contacts each month using a pencil eraser or cloth.
- Your headset or headset base might be malfunctioning. Please refer to the **Limited warranty** section on page 49 for further instructions.

## Troubleshooting

I cannot register the headset.

For registration to a cordless telephone:

- You must be using a compatible AT&T DECT 6.0 cordless telephone. Visit **[www.telephones.att.com](http://www.telephones.att.com)** for a list of compatible telephones.
- Your cordless telephone has a maximum number of handsets that may be registered to the telephone base. In terms of registration, the telephone base treats a headset like a handset. Check the **Adding and registering handsets** section of the telephone user's manual for the maximum number of handsets allowed. If the maximum number of handsets are already registered, you need to follow the de-registration instructions in the telephone user's manual then re-register the handsets and/or headsets you wish to use.

For registration to a headset base:

- You can register a maximum of two headsets and one dial pad to the headset base. If you already have two headset(s) and one dial pad registered to the headset base, then you must de-register all the headset(s) and dial pad before you register a different headset.
- If you registered the expansion headset to a headset base, see the user's manual for your headset base model TL7610/TL7611 for additional troubleshooting. Visit **[www.telephones.att.com](http://www.telephones.att.com)** to view or download the user manuals.

## Troubleshooting

Common cure for electronic equipment.

If the unit does not seem to be responding normally, try putting the cordless headset in its base or charger. If it does not seem to respond, do the following (in the order listed):

- Disconnect the power to the headset charger and the headset or telephone base.
- Disconnect the cordless headset battery.
- Wait a few minutes.
- Connect power to everything you unplugged.
- Re-install the battery, and place the cordless headset into the headset base or charger.
- Wait for the cordless headset to re-establish its connection with the headset or telephone base. Allow up to one minute for this to take place.

## Important safety information



This symbol is to alert you to important operating or servicing instructions that may appear in this user's manual. Always follow basic safety precautions when using this product to reduce the risk of injury, fire, or electric shock.

### Safety information

---

- **Read and understand all instructions in the user's manual. Observe all markings on the product.**
- **Avoid using a headset during a thunderstorm.** There may be a slight chance of electric shock from lightning.
- **Do not use a headset in the vicinity of a gas leak.** If you suspect a gas leak, report it immediately, but use a headset away from the area where gas is leaking. If this product is a cordless model, make sure the headset base is also away from the area.
- **Do not use this product near water, or when you are wet.** For example, do not use it in a wet basement or shower, or next to a swimming pool, bathtub, kitchen sink, or laundry tub. Do not use liquids or aerosol sprays for cleaning. If the product comes in contact with any liquids, unplug any line or power cord immediately. Do not plug the product back in until it has dried thoroughly.
- **Install this product in a protected location** where no one can trip over any line or power cords. Protect cords from damage or abrasion.
- **If this product does not operate normally, see the Troubleshooting section on pages 27-38 of this user's manual.** If you cannot solve the problem, or if the product is damaged, refer to the **Limited warranty** on pages 49-52. Do not open this product except as may be directed in your user's manual. Opening the product or reassembling it incorrectly may expose you to hazardous voltages or other risks.

## Important safety information

- **Replace batteries only as described in your user's manual.** Do not burn or puncture batteries — they contain caustic chemicals.
- **This power adapter is intended to be correctly oriented in a vertical or floor mount position.** The prongs are not designed to hold the plug in place if it is plugged into a ceiling or an under-the-table/cabinet outlet.

 **Caution:** Use only the power adapter provided with this product. To obtain a replacement, visit our website at **[www.telephones.att.com](http://www.telephones.att.com)** or call **1 (800) 222-3111**. In Canada dial **1 (866) 288-4268**.

### Especially about cordless headsets

---

- **Privacy:** The same features that make a cordless headset convenient create some limitations. Telephone calls are transmitted between the headset base and the headset by radio waves, so there is a possibility that your cordless headset conversations could be intercepted by radio receiving equipment within range of the cordless headset. **For this reason, you should not think of cordless headset conversations as being as private as those on corded telephones.**
- **Electrical power:** The headset base of this cordless headset must be connected to a working electrical outlet which is not controlled by a wall switch. **Calls cannot be made from the headset if the headset base is unplugged or switched off, or if the electrical power is interrupted.**
- **Potential TV interference:** Some cordless headsets operate at frequencies that may cause interference to TVs and VCRs. To minimize or prevent such interference, do not place the headset base of the cordless headset near or on top of a TV or VCR. If interference is experienced, moving the cordless headset farther away from the TV or VCR will often reduce or eliminate the interference.

## Important safety information

- **Rechargeable batteries:** This product contains nickel-cadmium, nickel-metal hydride or lithium-ion rechargeable batteries. Exercise care in handling batteries in order not to create a short circuit with conductive material such as rings, bracelets, and keys. The battery or conductor may overheat and cause harm. Observe proper polarity between the battery and the battery charger.
- **Lithium-ion rechargeable batteries:** Dispose of these batteries in a safe manner. Do not burn or puncture. Like other batteries of this type, if burned or punctured, they could release caustic material which could cause injury.



The RBRC™ Seal means that the manufacturer is voluntarily participating in an industry program to collect and recycle lithium-ion rechargeable batteries when taken out of service within the United States. These batteries may be taken to a participating local retailer of replacement batteries or recycling center. Or you may call 1-800-8-BATTERY for locations accepting spent Li-ion batteries.

### CAUTION

- Use only the batteries provided or their equivalent.
- Change this product's batteries only in accordance with the instructions and limitations specified in this manual.
- As with any batteries, do not allow conductive materials such as rings, bracelets, or keys to come in contact with the metallic parts of the battery. The battery or conductor may overheat and cause harm.
- Do not open or damage the batteries. Released electrolyte is corrosive and may cause injury to the eyes or skin. The electrolyte may be toxic if swallowed.
- Do not dispose of the batteries in a fire. Check with local waste management codes for special disposal instructions.

## Important safety information

- To prevent fire or shock hazard, do not expose this product to water or any type of moisture.
- Observe proper polarity orientation between the battery and metallic contacts.
- Do not disassemble your telephone. There are no user-serviceable parts inside. Refer to qualified service personnel for servicing.

### **Precautions for users of implanted cardiac pacemakers**

Cardiac pacemakers (applies only to digital cordless telephones):

Wireless Technology Research, LLC (WTR), an independent research entity, led a multidisciplinary evaluation of the interference between portable cordless telephones and implanted cardiac pacemakers. Supported by the U.S. Food and Drug Administration, WTR recommends to physicians that:

#### **PACEMAKER PATIENTS**

- Should keep cordless telephones at least six inches from the pacemaker.
- Should NOT place cordless telephones directly over the pacemaker, such as in a breast pocket, when it is turned ON.
- Should use the cordless telephone at the ear opposite the pacemaker.

WTR's evaluation did not identify any risk to bystanders with pacemakers from other persons using cordless telephones.

## **SAVE THESE INSTRUCTIONS**

## Maintenance

### **Taking care of your headset**

- Your cordless headset contains sophisticated electronic parts, so it must be treated with care.
- Avoid rough treatment.
- Place the headset down gently. Save the original packing materials to protect your headset if you ever need to ship it.

### **Avoid water**

- Your headset can be damaged if it gets wet. Do not use the headset outdoors in the rain, or handle it with wet hands. Do not install the headset base near a sink, bathtub or shower.

### **Electrical storms**

- Electrical storms can sometimes cause power surges harmful to electronic equipment. For your own safety, take caution when using electrical appliances during storms.

### **Cleaning your headset**

- Your headset has a durable plastic casing that should retain its luster for many years. Clean it only with a soft cloth slightly dampened with water or a mild soap.
- Do not use excess water or cleaning solvents of any kind.

Remember that electrical appliances can cause serious injury if used when you are wet or standing in water. If the headset base should fall into water, DO NOT RETRIEVE IT UNTIL YOU UNPLUG THE POWER CORD AND TELEPHONE LINE CORDS FROM THE WALL. Then pull the unit out by the unplugged cords.



## FCC Part 68 and ACTA

This equipment complies with Part 68 of the FCC rules and with technical requirements adopted by the Administrative Council for Terminal Attachments (ACTA). The label on the back or bottom of this equipment contains, among other things, a product identifier in the format US: AAAEQ##TXXXX. This identifier must be provided to your local telephone company upon request.

The plug and jack used to connect this equipment to premises wiring and the telephone network must comply with applicable Part 68 rules and technical requirements adopted by ACTA. A compliant telephone cord and modular plug is provided with this product. It is designed to be connected to a compatible modular jack that is also compliant. An RJ11 jack should normally be used for connecting to a single line and an RJ14 jack for two lines. See Installation Instructions in the user's manual.

The Ringer Equivalence Number (REN) is used to determine how many devices you may connect to your telephone line and still have them ring when you are called. The REN for this product is encoded as the 6th and 7th characters following the US: in the product identifier (e.g. if ## is 03, the REN is 0.3). In most, but not all areas, the sum of all RENs should be five (5.0) or less. For more information, please contact your local telephone company.

This equipment may not be used with Party Lines. If you have specially wired alarm dialing equipment connected to your telephone line, ensure the connection of this equipment does not disable your alarm equipment. If you have questions about what will disable alarm equipment, consult your telephone company or a qualified installer.

If this equipment is malfunctioning, it must be unplugged from the modular jack until the problem has been corrected. Repairs to this telephone equipment can only be made by the manufacturer or its authorized agents. For repair procedures, follow the instructions outlined under the Limited Warranty.

## FCC Part 68 and ACTA

If this equipment is causing harm to the telephone network, the telephone company may temporarily discontinue your telephone service. The telephone company is required to notify you before interrupting service. If advance notice is not practical, you will be notified as soon as possible. You will be given the opportunity to correct the problem and the telephone company is required to inform you of your right to file a complaint with the FCC. Your telephone company may make changes in its facilities, equipment, operation, or procedures that could affect the proper functioning of this product. The telephone company is required to notify you if such changes are planned.

If this product is equipped with a corded or cordless handset, it is hearing aid compatible.

If this product has memory dialing locations, you may choose to store emergency telephone numbers (e.g. police, fire, medical) in these locations. If you do store or test emergency numbers, please:

Remain on the line and briefly explain the reason for the call before hanging up.

Perform such activities in off-peak hours, such as early morning or late evening.

## FCC Part 68 and ACTA

### **Industry Canada**

Operation is subject to the following two conditions: (1) this device may not cause harmful interference, and (2) this device must accept any interference, including interference that may cause undesired operation.

The term "IC:" before the certification/registration number only signifies that the Industry Canada technical specifications were met.

The Ringer Equivalence Number (REN) for this terminal equipment is 0.1. The REN is an indication of the maximum number of devices allowed to be connected to a telephone interface. The termination on an interface may consist of any combination of devices subject only to the requirement that the sum of the RENs of all the devices does not exceed five.

This product meets the applicable Industry Canada technical specifications.

## FCC Part 15

This equipment has been tested and found to comply with the requirements for a Class B digital device under Part 15 of the Federal Communications Commission (FCC) rules.

These requirements are intended to provide reasonable protection against harmful interference in a residential installation. This equipment generates, uses and can radiate radio frequency energy and, if not installed and used in accordance with the instructions, may cause harmful interference to radio communications. However, there is no guarantee that interference will not occur in a particular installation.

If this equipment does cause harmful interference to radio or television reception, which can be determined by turning the equipment off and on, the user is encouraged to try to correct the interference by one or more of the following measures:

- Reorient or relocate the receiving antenna.
- Increase the separation between the equipment and receiver.
- Connect the equipment into an outlet on a circuit different from that to which the receiver is connected.
- Consult the dealer or an experienced radio/TV technician for help.

Changes or modifications to this equipment not expressly approved by the party responsible for compliance could void the user's authority to operate the equipment.

This device complies with Part 15 of the FCC Rules. Operation is subject to the following two conditions: (1) this device may not cause harmful interference, and (2) this device must accept any interference received, including interference that may cause undesired operation. Privacy of communications may not be ensured when using this device.

## FCC Part 15

To ensure safety of users, the FCC has established criteria for the amount of radio frequency energy that can be safely absorbed by a user or bystander according to the intended usage of the product. This product has been tested and found to comply with the FCC criteria. The headset may be safely held against the ear of the user. The headset base shall be installed and used such that parts of the user's body other than the hands are maintained at a distance of approximately 20 cm (8 inches) or more.

This Class B digital apparatus complies with Canadian ICES-003.

## Limited warranty

The AT&T brand is used under license - any repair, replacement or warranty service, and all questions about this product should be directed to: In the United States of America, visit

**www.telephones.att.com** or call **1 (800) 222-3111**. In Canada, call **1 (866) 288-4268**.

### 1. What does this limited warranty cover?

The manufacturer of this AT&T-branded product warrants to the holder of a valid proof of purchase (“CONSUMER” or “you”) that the product and all accessories provided in the sales package (“PRODUCT”) are free from defects in material and workmanship, pursuant to the following terms and conditions, when installed and used normally and in accordance with the PRODUCT operating instructions. This limited warranty extends only to the CONSUMER for products purchased and used in the United States of America and Canada.

### 2. What will be done if the PRODUCT is not free from defects in materials and workmanship during the limited warranty period (“materially defective PRODUCT”)?

During the limited warranty period, the manufacturer’s authorized service representative will repair or replace at the manufacturer’s option, without charge, a materially defective PRODUCT. If the manufacturer repairs the PRODUCT, they may use new or refurbished replacement parts. If the manufacturer chooses to replace the PRODUCT, they may replace it with a new or refurbished PRODUCT of the same or similar design. The manufacturer will retain defective parts, modules, or equipment. Repair or replacement of the PRODUCT, at the manufacturer’s option, is your exclusive remedy. The manufacturer will return repaired or replacement products to you in working condition. You should expect the repair or replacement to take approximately 30 days.

## Limited warranty

### 3. How long is the limited warranty period?

The limited warranty period for the PRODUCT extends for ONE (1) YEAR from the date of purchase. If the manufacturer repairs or replaces a materially defective PRODUCT under the terms of this limited warranty, this limited warranty also applies to repaired or replacement PRODUCT for a period of either (a) 90 days from the date the repaired or replacement PRODUCT is shipped to you or (b) the time remaining on the original one-year limited warranty; whichever is longer.

### 4. What is not covered by this limited warranty?

This limited warranty does not cover:

- PRODUCT that has been subjected to misuse, accident, shipping or other physical damage, improper installation, abnormal operation or handling, neglect, inundation, fire, water, or other liquid intrusion; or
- PRODUCT that has been damaged due to repair, alteration, or modification by anyone other than an authorized service representative of the manufacturer; or
- PRODUCT to the extent that the problem experienced is caused by signal conditions, network reliability or cable or antenna systems; or
- PRODUCT to the extent that the problem is caused by use with non-AT&T accessories; or
- PRODUCT whose warranty/quality stickers, PRODUCT serial number plates or electronic serial numbers have been removed, altered or rendered illegible; or
- PRODUCT purchased, used, serviced, or shipped for repair from outside the United States of America or Canada, or used for commercial or institutional purposes (including but not limited to products used for rental purposes); or

## Limited warranty

- PRODUCT returned without valid proof of purchase (see item 6 below); -or-
  - Charges for installation or setup, adjustment of customer controls, and installation or repair of systems outside the unit.
5. How do you get warranty service?

To obtain warranty service in the United States of America, visit **[www.telephones.att.com](http://www.telephones.att.com)** or call **1 (800) 222-3111**. In Canada, call **1 (866) 288-4268**. NOTE: Before calling for service, please review the user's manual; a check of the PRODUCT controls and features may save you a service call.

Except as provided by applicable law, you assume the risk of loss or damage during transit and transportation and are responsible for delivery or handling charges incurred in the transport of the PRODUCT(s) to the service location. The manufacturer will return repaired or replaced PRODUCT under this limited warranty to you. Transportation, delivery or handling charges are prepaid. The manufacturer assumes no risk for damage or loss of the PRODUCT in transit. If the PRODUCT failure is not covered by this limited warranty, or proof of purchase does not meet the terms of this limited warranty, the manufacturer will notify you and will request that you authorize the cost of repair prior to any further repair activity. You must pay for the cost of repair and return shipping costs for the repair of products that are not covered by this limited warranty.

6. What must you return with the PRODUCT to get warranty service?  
You must:
- a. Return the entire original package and contents including the PRODUCT to the service location along with a description of the malfunction or difficulty; and
  - b. Include "valid proof of purchase" (sales receipt) identifying the PRODUCT purchased (PRODUCT model) and the date of purchase or receipt; and
  - c. Provide your name, complete and correct mailing address, and telephone number.



## Limited warranty

### 7. Other limitations

This warranty is the complete and exclusive agreement between you and the manufacturer of this AT&T branded PRODUCT. It supersedes all other written or oral communications related to this PRODUCT. The manufacturer provides no other warranties for this PRODUCT. The warranty exclusively describes all of the manufacturer's responsibilities regarding the PRODUCT. There are no other express warranties. No one is authorized to make modifications to this limited warranty and you should not rely on any such modification.

**State/Provincial Law rights:** This warranty gives you specific legal rights, and you may also have other rights which vary from state to state or province to province.

**Limitations:** Implied warranties, including those of fitness for a particular purpose and merchantability (an unwritten warranty that the PRODUCT is fit for ordinary use) are limited to one year from date of purchase. Some states/provinces do not allow limitations on how long an implied warranty lasts, so the above limitation may not apply to you. In no event shall the manufacturer be liable for any indirect, special, incidental, consequential, or similar damages (including, but not limited to lost profits or revenue, inability to use the PRODUCT or other associated equipment, the cost of substitute equipment, and claims by third parties) resulting from the use of this PRODUCT. Some states/provinces do not allow the exclusion or limitation of incidental or consequential damages, so the above limitation or exclusion may not apply to you.

**Please retain your original sales receipt as proof of purchase.**

## Technical specifications

RF frequency band	1921.536 MHz — 1928.448 MHz
Channels	5
Operating temperature	32°F — 122°F 0°C — 50°C
Headset voltage	3.2 — 4.2 VDC
Charger voltage (AC adapter output)	6VDC @200mA
Replacement battery	3.7V 240mAH

### Operating range

This cordless headset operates within the maximum power allowed by the Federal Communications Commission (FCC). Even so, this headset and headset base can communicate over only a certain distance — which can vary with the locations of the headset base and headset, the weather, and the construction of your home or office.

### Extended range and clarity

The TL7600/TL7610/TL7611 are fully cordless DECT 6.0 headsets offering a range of up to 500 ft. Sound level protection technology conforms to the current regulations and is used to filter out the loud and high-pitched noises.

## Index

### A

---

AC adapter, 2  
Alert tones, 23  
Answering calls, 18  
Auto off, 18

### B

---

Battery charging, 4  
Battery installation, 3

### C

---

Call waiting, 20

### D

---

De-registration, 25  
DSL, 1, 32

### E

---

Ear hook headset  
attachment, 9-11  
Ending calls, 18

### F

---

Flash (switch hook flash), 20

### H

---

Headband headset  
attachment, 12-13  
Headset buttons, 8  
Headset operation, 17

### I

---

Incoming calls, answering,  
18  
Indicator lights, 24  
Intercom, 19

### L

---

Lights, 24  
Listening volume, 20

### M

---

Maintenance of your  
headset, 43  
Making calls, 17  
Multiple headset/handset  
use, 22  
Mute, 22

### N

---

Neckband headset  
attachment, 14-16

### O

---

Operating range, 53

### Q

---

Quick reference guide, 8

### R

---

Receiving calls, 18  
Registering the headset, 5  
Replacing a headset, 25-26  
Ring tone silencing, 19

### S

---

Safety information, 39-42  
Switching a call, 21

## Index

### **T**

---

Technical specifications, 53

Temporary ring tone silencing,  
19

Troubleshooting, 27-38

### **V**

---

Volume controls, 20

### **W**

---

Warranty, 49-52



**[www.telephones.att.com](http://www.telephones.att.com)**