



User's Guide

AT&T SB67030/SB67031 Deskset and Accessories



CONTENTS

Preface	8
Additional Documentation	8
Topic Navigation	9
Text Conventions	9
Overview	10
Synapse System Overview	11
Deskset Description.....	12
Deskset Hard Keys.....	13
Deskset Idle Screen.....	14
Modes of Operation	15
Call Appearance Mode	15
Line Appearance Mode.....	16
Setting Your Password.....	16
Deskset Soft Keys.....	17
Deskset Status Indicators.....	18
Call Indicators in Call Appearance Mode	19
Call Indicators in Line Appearance Mode	20
Call Status Icons.....	21
Call Status LEDs.....	21
Deskset Dial-Pad Entry	23
Using the Speakerphone.....	24
Using Help Screens.....	24
About the Auto Attendant.....	25
Caller Options	25
SB67040 Cordless Handset (Optional).....	26
Cordless Handset Description.....	27
Cordless Handset Liquid Crystal Display (LCD)	29
Cordless Handset Soft Keys.....	31
Cordless Handset Screen Icons.....	31
Using the Cordless Handset Speakerphone	32
Switching Between Deskset and Cordless Handset	32
Deskset/SB67040 Cordless Handset Comparison	33
Deskset-Handset Interaction	35
Answering a Call While Another Device is on a Call	35



Incoming Calls.....	35
Held Calls.....	35
Clocks	35
Status.....	35
Cordless Handset Battery Charging.....	36
Cordless Handset Low Battery Notification	36
Power-Save Mode.....	37
Cordless Handset Connection Loss Notification	38
Searching a List Using the Cordless Handset Dial Pad	38
Dial-Pad Entry.....	39
TL7600 Cordless Headset (Optional).....	40
Cordless Headset Description.....	41
Cordless Headset Operation.....	42
Outgoing Calls	43
Active Call Screen.....	44
Predialing.....	45
Live Dialing	46
Making a Call from a List.....	47
Calling a Busy Extension	48
Making an Intercom Call.....	49
Calling a Restricted Number.....	50
Calling Restricted Numbers on Your Extension.....	50
Calling Restricted Numbers Using Another Extension	51
Making Calls with the Cordless Handset.....	52
Active Call Screen.....	52
Predialing	53
Live Dialing.....	54
Making Calls with the Optional TL7600 Cordless Headset.....	55
Incoming Calls	56
Incoming Call Screen.....	57
Incoming Call Indication	58
Call Appearance Mode	58
Line Appearance Mode.....	59
Answering a Call.....	60
Ignoring a Call.....	61
Forwarding All Calls.....	62
Call Screening	63
Auto Answering.....	64
Answering Calls in the Call Queue.....	65
Answering Calls from Idle Mode.....	65
Viewing the Queued Calls List.....	66
Answer a Call with the Cordless Handset	67
Incoming Call Indication	68
Answering a Call.....	69
Multiple Incoming Calls.....	69



Call Management	71
Call Management.....	72
Putting a Call on Hold (Call Appearance Mode).....	73
Putting a Call on Hold (Line Appearance Mode).....	74
Transferring a Call.....	75
Transferring a call to a busy extension.....	77
Making a Conference Call.....	78
Putting a Conference on Hold.....	79
Ending a Conference.....	80
Parking a Call.....	81
Retrieving a Parked Call.....	82
Call Management Using the Cordless Handset.....	83
Active Call Screens.....	84
Transferring.....	85
Transferring to an Extension.....	85
Transferring to an Outside Number.....	86
Making a Conference Call.....	87
Putting a Conference Call on Hold.....	88
Ending a Conference Call.....	88
Managing Held Calls.....	90
Held Call Options.....	91
Parking a Call.....	92
Parking an Active or Held Call.....	92
Retrieving a Parked Call From Any Extension.....	92
Using a Corded Headset.....	94
Call Management Using a Headset.....	95
Accessing Items in Lists	96
Accessing the Queued Calls List.....	97
Accessing the Park List.....	98
Accessing Voicemail.....	99
About the Extension List.....	101
Accessing the Extension List.....	102
Accessing the Quick-Dial List.....	103
Editing Quick Dial Entries.....	103
About the Redial List.....	105
Accessing the Redial List.....	106
Deleting Redial Entries.....	107
Searching the Directory or Extension Lists Using the Dial Pad.....	108
Accessing the Held Calls List.....	109
Accessing and Managing Items in Lists with the Cordless Handset.....	110
About the Cordless Handset Extension List.....	111
Accessing an Extension with the Cordless Handset.....	111
Accessing the Quick-Dial List with the Cordless Handset.....	112
Accessing the Redial List with the Cordless Handset.....	113
Searching the Directory or Extension Lists Using the Dial Pad.....	114



Directory	115
Using the Directory.....	116
Viewing Directory Entries.....	117
Creating a New Personal List Entry.....	119
Editing a Personal List Entry.....	120
Storing Directory Entries from the Call Log or Redial List.....	121
Deleting a Personal List Entry	122
Sorting Directory Entries.....	123
Accessing the Directory with the Cordless Handset	124
Voicemail	126
Voicemail Overview	127
Group Mailbox Overview	129
Accessing Your Messages	131
Message Playback.....	132
Forwarding a Message.....	135
Forwarding a Voicemail Message	135
Recording an Introduction to Send with a Forwarded Message.....	137
Sending a New Message to a Distribution List.....	138
Deleting Messages.....	140
New Message Status Indications (! Icons).....	141
Accessing Your Voicemail Remotely.....	142
Accessing Personal Voicemail with the Cordless Handset.....	145
Voicemail Notification on the Cordless Handset.....	146
Retrieving Personal Voicemail with the Cordless Handset.....	147
Reviewing Messages with the Cordless Handset.....	148
Managing Personal Voicemail with the Cordless Handset.....	149
Call Log	151
Using the Call Log	152
Managing Missed Calls.....	154
Reviewing the Call Log List.....	155
Listening to Voicemail From the Call Log.....	156
Storing Call Log Entries.....	157
Deleting Call Log Entries.....	158
Accessing the Call Log with the Cordless Handset	160
Using the Call Log with the Cordless Handset	161
Managing Missed Calls with the Cordless Handset	162
Reviewing the Call Log with the Cordless Handset.....	162
Playing Voicemail Messages in the Call Log with the Cordless Handset.....	163
Deleting Call Log Entries with the Cordless Handset.....	163
Paging.....	165
Paging All Extensions or a Paging Zone	166
Single-Zone Overhead Paging	167
Multi-Zone Overhead Paging.....	168
Paging with the Cordless Handset	169



Deskset Settings	170
Deskset Menu	171
Deskset Settings	172
Display	173
Sounds	173
Preferred Audio	175
User Settings.....	176
Greetings	177
Recording a Greeting.....	179
Call Forward All and Call Forward–No Answer	179
Automatic Answering	181
Voicemail Memory.....	182
Name Recording	183
Registering an Optional Cordless Handset	185
Registering an Optional Cordless Headset	186
Deregistering a Cordless Handset or Headset	187
Deregistering the Cordless Handset or Headset without the Deskset.....	189
Cordless Accessory Registration and Deregistration Time-Out.....	190
Setting and Changing Your Password	191
Setting the Voicemail to Email Mode.....	192
Admin Settings.....	193
Deskset Information	194
Using Do Not Disturb (DND)	195
Auto-Attendant Settings	196
Cordless Handset Settings.....	198
Setting Cordless Handset Contrast	199
Setting the Cordless Handset Sounds	199
Setting the Cordless Handset Ringer and Voice Volume	200
Setting the Cordless Handset to Factory Default.....	201
Viewing the Cordless Handset Product ID.....	201
 Web Interface	 202
Accessing the Web User Interface (WebUI).....	203
Error Handling	205
Basic Settings.....	206
Extension Directory	208
Quick-Dial Keys	210
Voicemail Distribution	211
Help	214
 Troubleshooting	 215
Common Troubleshooting Procedures.....	216
Display Messages.....	218
Calls Generally.....	220
Incoming Calls.....	224
Outgoing Calls	226
Voicemail	228
Other Deskset Features.....	231
WebUI.....	234



PC/Deskset Interaction	235
SB67040 Cordless Handset.....	236
TL7600 Cordless Headset	242
Appendixes	247
Appendix A: Soft Keys.....	247
Deskset Soft Keys.....	247
Cordless Handset Soft Keys.....	249
Appendix B: Technical Specifications	250
Appendix C: Maintenance.....	251
Appendix D: Important Safety Instructions.....	252
Glossary	253



PREFACE

This User's Guide provides instructions for using your Synapse SB67030/031 telephone with firmware version 2.0 or newer, and its optional accessories. See [page 194](#) for instructions on checking the firmware version on the Deskset. Although the Quick Start Guides also include information on using the devices, this guide has information on setting up the devices and more complete information on feature usage.

Before using this AT&T product, please read "[Appendix D: Important Safety Instructions](#)" on [page 252](#). Please thoroughly read this user's guide for all the feature operations and troubleshooting information necessary to operate your new AT&T product.

**NOTE**

For customer service or product information, contact the person who installed your system. If your installer is unavailable, visit our web site at www.telephones.att.com/smb or call **1 (888) 916-2007**. In Canada, dial **1 (888) 883-2474**.

Additional Documentation



Downloadable copies of all Synapse documents, including user's and administrator's guides, installation instructions and Quick Start Guides, are available at www.telephones.att.com/synapseguides.





Topic Navigation

This Synapse SB67030/031 Deskset & Accessories User's Guide features easy navigation between topics and the ability to return to your original topic.

Text in blue indicates a link to another page in the document. **Bold text in blue** indicates a hyperlink to an external web site.



You can also click the arrows at the bottom of the page to move around this document.

	Go back to the last page viewed.
	Go to the previous page.
	Go to the next page.

Text Conventions

Table 1 lists text formats and describes how they are used in this guide.

Table 1. Description of Text Conventions

Text Format	Description
Screen	Identifies text that appears on a device screen or a WebUI page in a title, menu, or prompt.
HARD KEY or DIAL-PAD KEY	Identifies a hard key, including the dial-pad keys.
CallFwd	Identifies a soft key.
 NOTE	Notes provide important information about a feature or procedure. Example of a Note.
 CAUTION	A caution means that loss of data or unintended circumstances may result. Example of a Caution.



CHAPTER
1

OVERVIEW

The Synapse® Business Phone System from AT&T is for businesses that need up to 100 extensions. This system is scalable from 1 to 39 outside lines, so as your business grows, your phone system can too. The Synapse Business Phone System provides simplicity without sacrifice — it's simple to install, manage, and use, without sacrificing any of the features you need and expect from a business telephone system.

This chapter introduces the SB67030/031 Deskset and accessories and provides an overview of the Synapse System and the external features of the Deskset.

- ["Synapse System Overview" on page 11](#)
- ["Deskset Description" on page 12](#)
- ["SB67040 Cordless Handset \(Optional\)" on page 26](#)
- ["TL7600 Cordless Headset \(Optional\)" on page 40.](#)



Synapse System Overview

Your Deskset is part of the Synapse System. Synapse differs from conventional telephone systems in that calls are not coordinated by a central controller. Instead, Synapse uses a distributed control system over a Local Area Network (LAN). Figure 1 illustrates a sample system with outside telephone connections in **blue** and Ethernet cables in **red**.

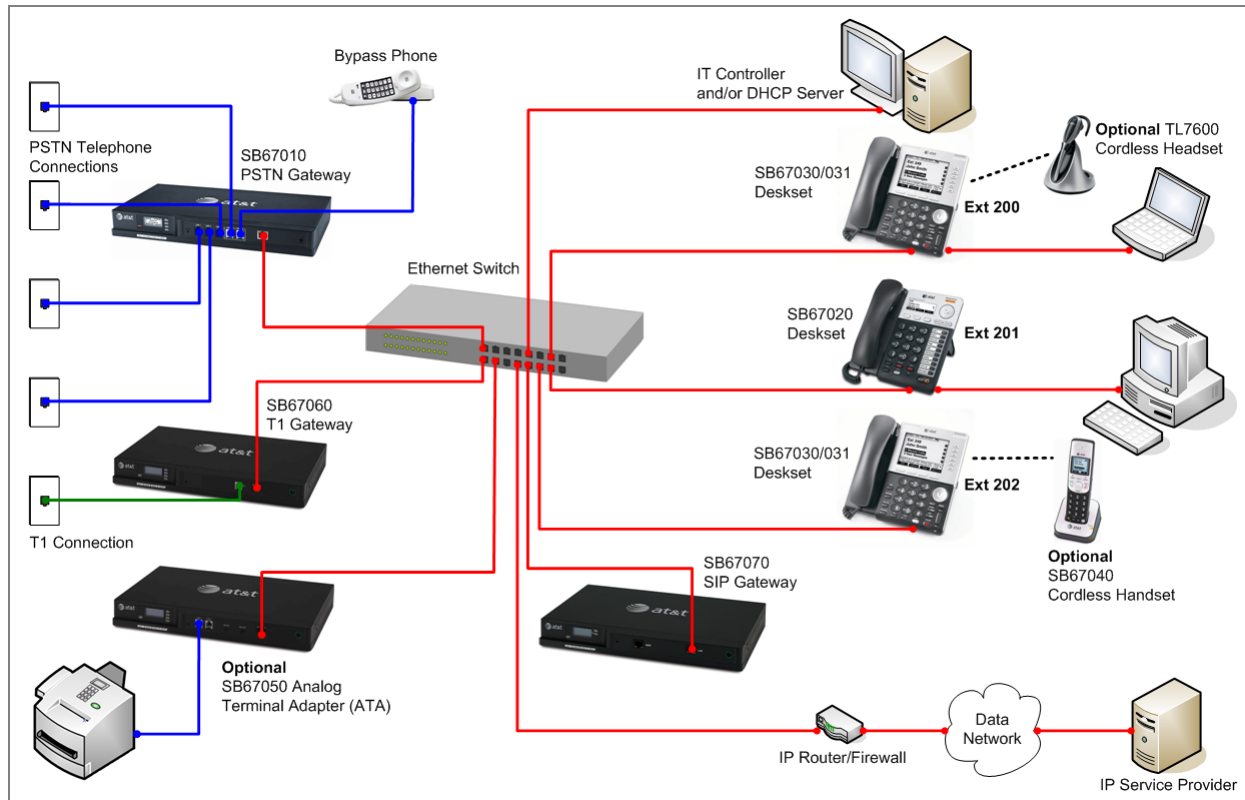

Figure 1. Sample Synapse System



Deskset Description

The key external features of the Deskset are shown in Figure 2 and described in Table 2.

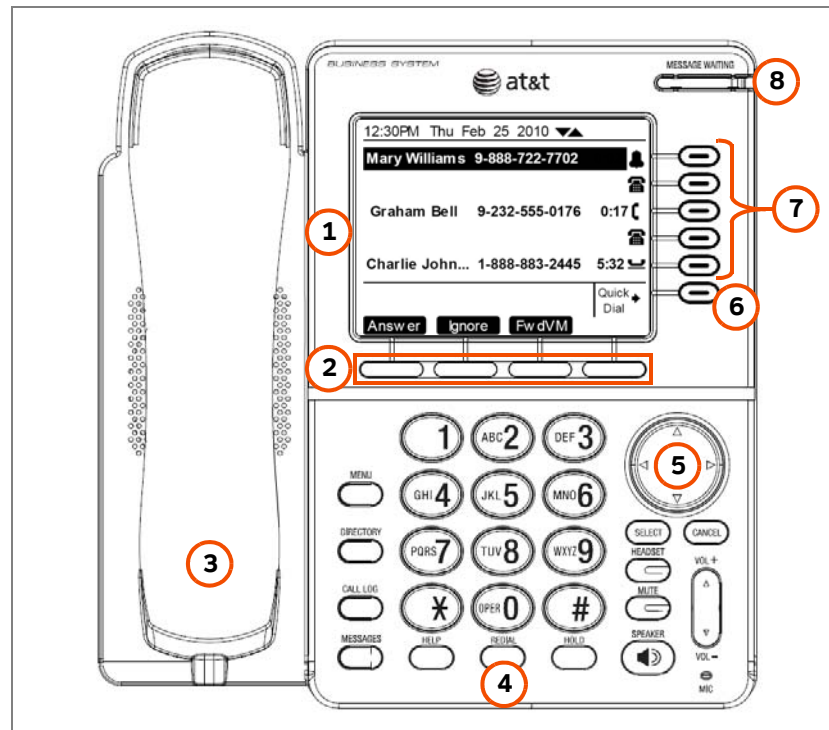

Figure 2. Deskset External Features

Table 2 Deskset External Features

1. Liquid Crystal Display (LCD)	Provides controls and information for using the Deskset.
2. Soft Keys	Four keys that produce different actions, depending on the LCD labels.
3. Corded Handset	Traditional 2-conductor wiring (FXO — Foreign Exchange Office Ports).
4. Hard Keys	Fixed-function keys. See “Deskset Hard Keys” on page 13.
5. Navigation Key	Moves the cursor up/down/left/right on the display.
6. Quick Dial or Call Queue Key	Provides easy access to frequently dialed numbers or to the Call Queue, depending on your system setup.
7. Call Appearance/Line Appearance Keys	Five keys that access active calls and held calls.
8. Voicemail Indicator	Illuminates when there are new Voicemail messages.



Deskset Hard Keys

The hard keys include the standard telephone dial-pad keys and the function keys shown in Figure 3 and defined in Table 3.

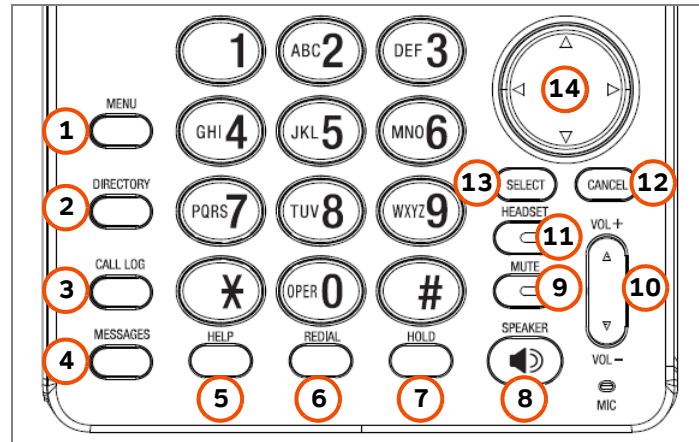

Figure 3. Deskset Function Keys

Table 3 Deskset Function Keys

1. MENU	Accesses the configuration menu.
2. DIRECTORY	Accesses the Directory.
3. CALL LOG	Accesses the incoming Call Log.
4. MESSAGES	Accesses Voicemail.
5. HELP	Accesses Help.
6. REDIAL	Accesses the Redial list.
7. HOLD	Puts current active call on hold. Allows access to other calls and features while maintaining call connection.
8. SPEAKER	During a call, switches voice to and from the speakerphone. Can be used to answer or start a call, or to hang up.
9. MUTE	Mutes the microphone. When on, the other party cannot hear you. Does not mute the optional Cordless Headset.
10. VOL+/VOL-	Increases or decreases the ringer and voice volume.
11. HEADSET	Routes audio to corded headset or Cordless Headset. Can be used to go off hook.
12. CANCEL	Cancels the most recent operation and returns to previous function.
13. SELECT	Usually selects a highlighted option. Dials highlighted phone numbers.
14. Navigation	Moves the cursor up (Δ), down (∇), left (\triangleleft), right (\triangleright) on the display.



Deskset Idle Screen

Figure 4 identifies the basic elements of the Idle screen in Call Appearance mode (see [“Modes of Operation” on page 15](#)). Table 4 describes the call functions displayed on the Idle Screen. The Idle screen appears when the system is first turned on and when there is no call activity. The display is backlit when you are using it, but the backlight turns off 30 seconds after the most recent button press.

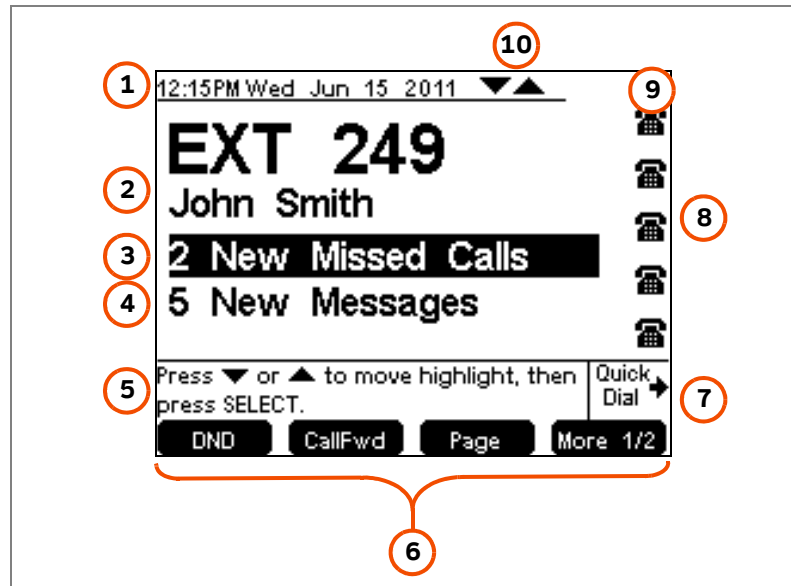

Figure 4. Idle Screen

Table 4 Idle Screen

1. Time and Date	
2. Extension Number and Name	Your extension number and name appear in the Idle screen. Extensions may be 3 or 4 digits.
3. New Missed Calls (Call Appearance mode only)	Press SELECT when this is highlighted to display the name, number, and time of recently received calls.
4. New Messages	Press SELECT when this is highlighted to access the list of new Voicemail messages.
5. Help	Brief, context-sensitive help for the current screen.
6. Soft Keys	See “Deskset Soft Keys” on page 17 .
7. Quick Dial or Call Queue	When the nearby key is pressed, the Call/Line Appearance icons change to display up to six Quick-Dial numbers. If Call Queue is set up (Call Appearance mode only), pressing the key displays the Call Queue list, where you can view and retrieve calls in the Call Queue.
8. Call Appearance/Line Appearance Icons	Show whether there is an active, conference, or held call, or whether there is a line available for making a call.
9. Status Messages	Status indicators appear in this space.
10. Navigation Arrows	Appear when pressing \triangle and ∇ on the navigation key will move the highlight.

Modes of Operation

The system administrator can configure the Synapse system to operate in one of two different modes: Call Appearance mode and Line Appearance mode. Desksets operate differently in each mode. The appearance mode affects how you make, answer, and manage calls. Each mode provides a unique set of configurable features. This User's Guide includes information about, and procedures for, both Call Appearance mode and Line Appearance mode.

You know when your Deskset is in Call Appearance mode when the Idle screen displays **New Missed Calls** as shown in Figure 5. The Idle screen appears when the Deskset is first turned on and when there is no call activity. In Line Appearance mode, the Deskset does not display missed calls.

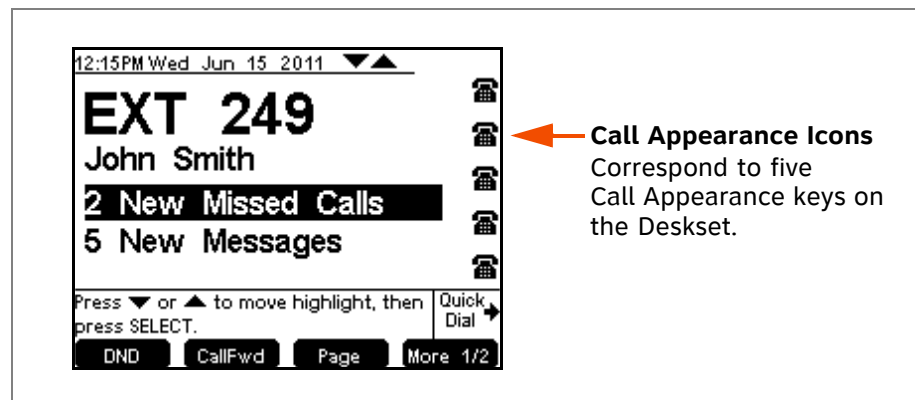

Figure 5. Idle Screen in Call Appearance mode

Call Appearance Mode

In Call Appearance mode, your Deskset has five virtual “lines” on which you can make and receive calls. These lines are called Call Appearances in this User's Guide. You can use Call Appearances for calls to and from external numbers (232-555-0176, for example) or to and from other Synapse Deskset extensions (Extension 220, for example). You can access each Call Appearance by pressing a Call Appearance key, as shown in [Figure 2 on page 12](#).

Line Appearance Mode

In Line Appearance mode, the Idle Screen appears as shown in Figure 6.

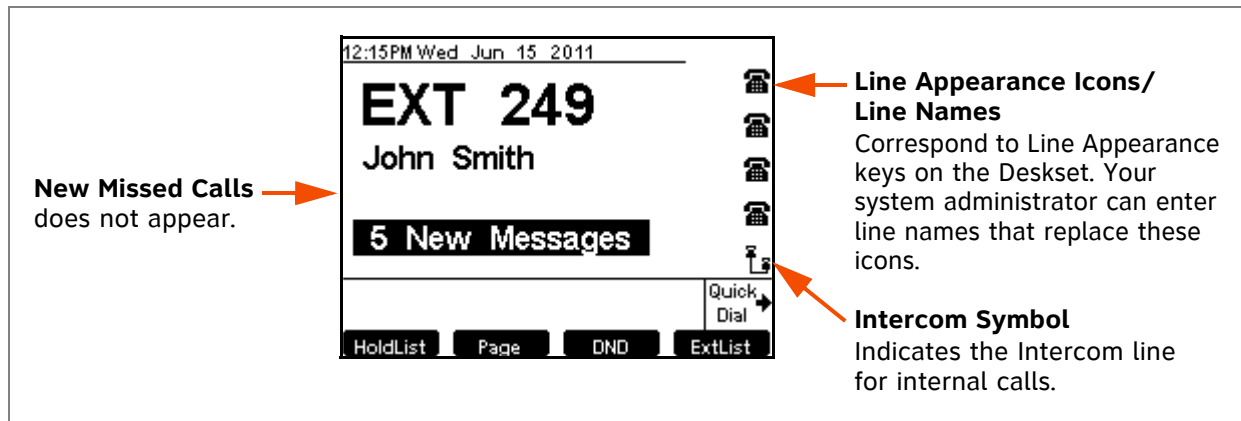

Figure 6. Idle Screen in Line Appearance mode

In Line Appearance mode, each line corresponds to a Line Appearance key on the Deskset as shown in [Figure 2 on page 12](#). Unlike Call Appearance mode, each Line Appearance key represents an actual physical line connected to the PSTN Gateway (the Synapse system can have up to four PSTN Gateways providing up to 16 lines). The system administrator can configure your Deskset with up to four lines on which you can make and receive external calls. One key is reserved for “Intercom” calls to other Synapse Deskset extensions.

Other Desksets in the system share these lines and display the line status. Incoming calls on a line ring at all Desksets that share that line. The Line Appearance key LED indicates whether a line is ringing, busy, or on hold.

The Line Appearance keys are used for receiving and making calls to external numbers. To call another extension in your office, you must use an Intercom key. By default, the Intercom key is the fifth key, but your system administrator can configure additional Intercom keys.

Setting Your Password

You can protect your Deskset by setting a password that prevents other users from accessing your User Settings and Voicemail. If you create a password, you will need to enter it before accessing User Settings, Voicemail, and the WebUI. You will also need to enter your password before calling a restricted number. See [“Calling a Restricted Number” on page 50](#).

For more information, see [“Setting and Changing Your Password” on page 191](#).



Deskset Soft Keys

The Deskset provides soft keys as illustrated in Figure 7. The soft key labels change according to the current task. For example, if you are holding a call, the key labels displayed are different from those displayed if you are making a call. See ["Appendix A: Soft Keys" on page 247](#) for an alphabetical list of the labels that appear above the soft keys.

Table 5 and Table 6 describe the Deskset Idle screen soft keys, as shown in Figure 7.

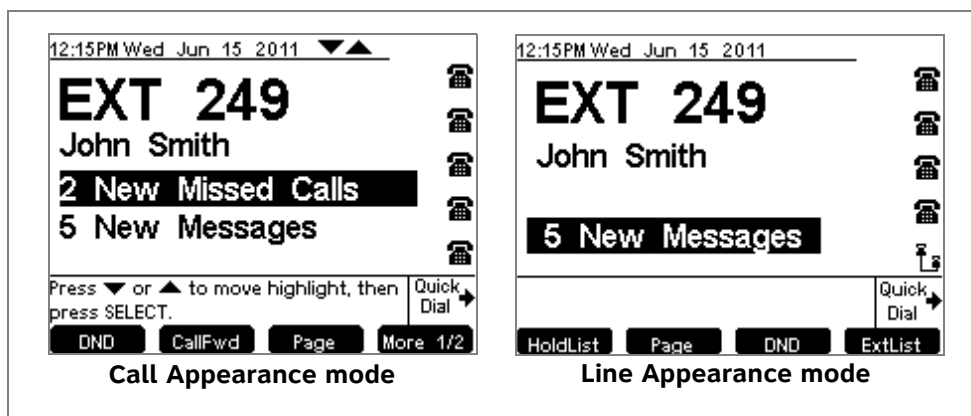

Figure 7. Deskset Idle Screen

Table 5 Idle Screen Soft Keys (Call Appearance Mode)

Key	Description	Key	Description
DND	Turns Do Not Disturb on or off.	CallFwd	Turns Call Forward on or off.
Page	Pages internal extensions.	ExtList	Accesses Extension list.
ParkList	Accesses Park list.	LocateHS	Rings the Cordless Handset, if a Handset is registered to the Deskset.
More	Moves to the next set of soft keys. If this key appears, there are more than four soft keys available. More 1/2 indicates that you are on page one of two.		

Table 6 Idle Screen Soft Keys (Line Appearance Mode)

Key	Description	Key	Description
HoldList	Accesses Held Calls list.	Page	Pages internal extensions.
DND	Turns Do Not Disturb on or off.	ExtList	Accesses Extension list.



Deskset Status Indicators

Status indicators appear in the upper right-hand corner of the Deskset display, as shown in Figure 8 and Figure 9.



12:30PM Thu Feb 25 2010 ▼▲ **DND ON**

Figure 8. Example of DND On

12:30PM Thu Feb 25 2010 ▼▲ **FWD ON**

Figure 9. Example of Call Forward On

Status messages include:

- ANS ON** Auto Answer is on (**Call Appearance mode only**).
- DND ON** Do Not Disturb is on.
- FWD ON** Call Forward All is on (**Call Appearance mode only**).
- VM Full** Voicemail is full.
- < 5 Min** Less than five minutes of Voicemail recording time is available.
-  Ringer volume set to zero. The ringer is silent.
-  Audible Ring Delay is 10 seconds. The number indicates the delay you have set.



The silent ringer and the Voicemail indicators alternate with each other and the other status indications. When Do Not Disturb is on, there is no indication for Auto Answer or Audible Ring Delay. When Call Forward All is on, the Do Not Disturb, Auto Answer, and Audible Ring Delay indicators do not appear.



Call Indicators in Call Appearance Mode

If your system is set to Call Appearance mode, the five Call Appearance keys, as shown in Figure 10, allow you to manage your calls. The Deskset presents call information next to the Call Appearance keys at the side of the display. When there is an incoming call, the Call Appearance key LED flashes. Icons on the screen identify the status of each call. Press \triangle or ∇ to move the highlight. The soft keys change accordingly. See ["Call Status Icons" on page 21](#) for a complete description of the available icons.

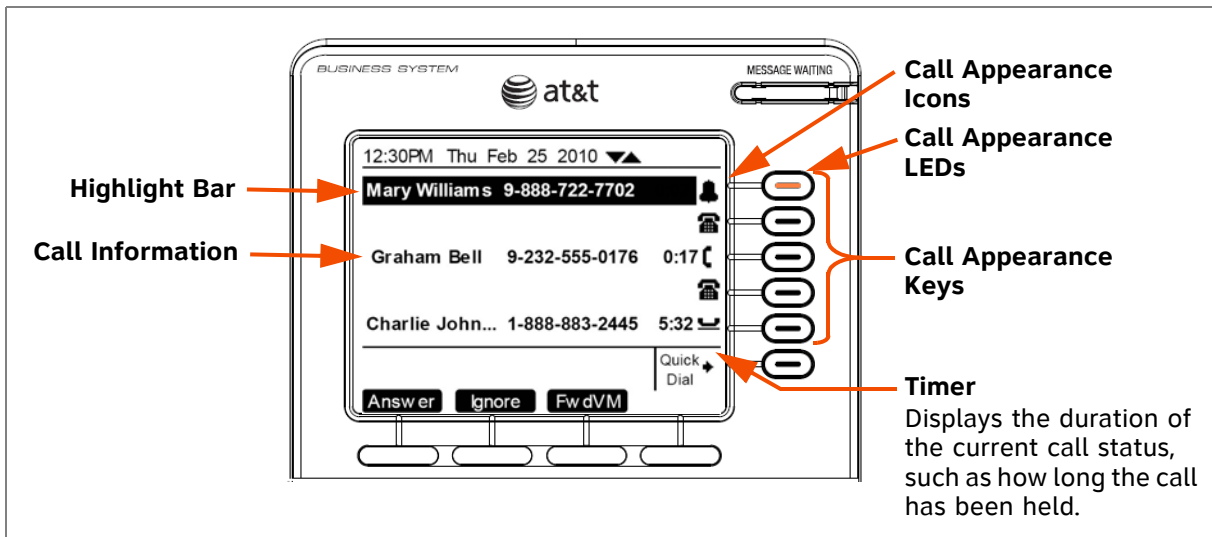

Figure 10. Sample Call Appearance Screen

Conferencing or transferring outside calls requires two Call Appearances; one for each call. When you are in a feature such as the Directory, Call Log, Redial, or Voicemail, pressing a Call Appearance key does not dial a highlighted list entry.

Call Indicators in Line Appearance Mode

If your system is set to Line Appearance mode, the Line Appearance keys, as shown in Figure 10, allow you to manage your calls. The Deskset presents call information next to the Line Appearance keys at the side of the display. When there is an incoming call, the Line Appearance key LED flashes. Icons on the screen identify the status of each call. When there are several lines active, press Line Appearance keys to access calls. The soft keys change accordingly. See ["Call Status Icons" on page 21](#) for a complete description of the available icons.

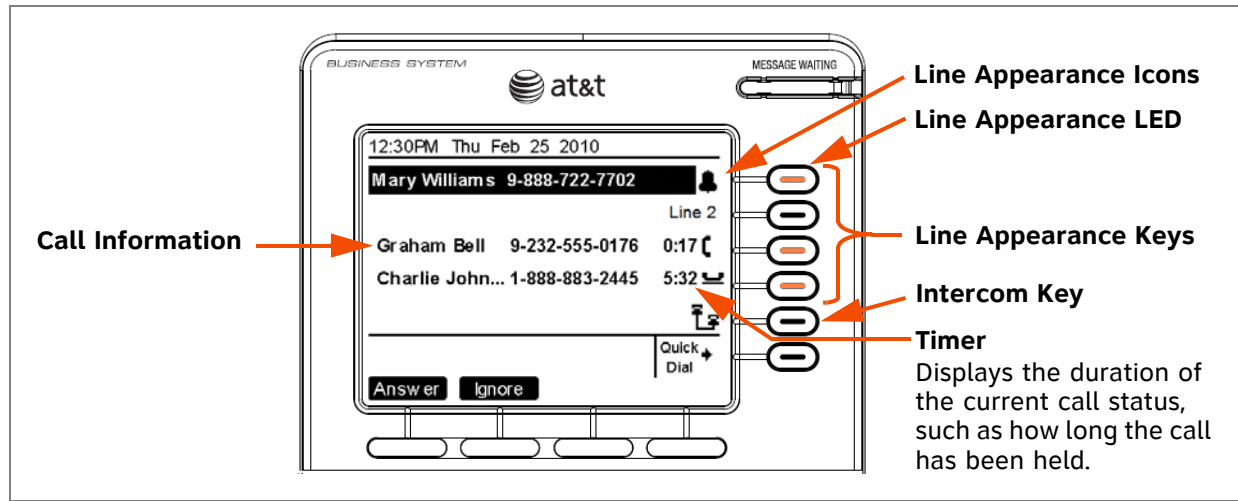















Figure 11. Sample Line Appearance Screen

Call Status Icons

Table 7 shows and describes the call status icons.

Table 7 Deskset Call Status Icons

Icon	Status	Icon	Status
	Available Indicates an available Call Appearance (or Line Appearance if the system administrator has not named your lines). Lifting the corded handset changes the icon from Available to Off Hook.		Incoming Call Indicates an incoming call when there are no other calls.
	Intercom Line Appearance mode only — Indicates an available Intercom line for internal calls.		Ringing Indicates an incoming call.
	Off Hook Indicates that you have lifted the corded handset, pressed SPEAKER or HEADSET , or you are on a phone call.		Silenced Ring Indicates an ignored incoming call.
	Predial Call Appearance mode only — Indicates that you have pressed at least one dial-pad key. These numbers are dialed when you go off hook.		Ring Group or Call Queue Ringing Call Appearance mode only — Indicates an incoming Ring Group or Call Queue call.
	Call Screening Call Appearance mode only — Indicates the caller is leaving a message. You can answer the call, listen to the recording in progress, or return to the idle screen.		On Hold Indicates you have put the call on hold.
	Conference Indicates a conference call.		Conference On Hold Indicates you have put a conference call on hold.
	Cordless Handset Call Appearance mode only — Indicates that the optional Cordless Handset is currently in control of operations.		

Call Status LEDs

The Call Status LED flash patterns indicate call status as described in Table 8. In Call Appearance mode, the LEDs indicate call status for a single Deskset. In Line Appearance mode, all Desksets that share lines also display the same LED activity. For example, if someone puts a call on line 3 on hold, the Line Appearance key for line 3 flashes slowly on all the Desksets that share PSTN line 3.

Table 8 Deskset Call Status LED Activity

LED Activity	Description
Off	No Call
Steady On	Active Call
Fast Flash	Ringing Call
Slow Flash	Held Call



Deskset Dial-Pad Entry

Use the dial-pad keys to enter letters and numbers into a text field. Keys **2**, **3**, **4**, **5**, **6**, and **8** have three assigned letters, while keys **7** and **9** have four assigned letters, as shown in Figure 12.

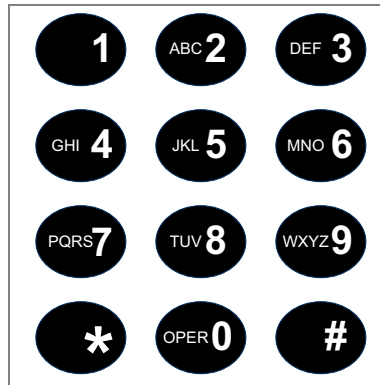

Figure 12. Dial Pad

Pressing **1** once enters a **space**; pressing it twice enters a **1**.

Pressing a key numbered **2** to **9** enters characters in the following order:

1. Upper-case letters.
2. Key number.
3. Lower-case letters.

For example, pressing **2** cycles through A, B, C, 2, a, b, c. Pressing **7** cycles through P, Q, R, S, 7, p, q, r, s.

For text fields that accept only numbers, pressing a key once enters a number.

You can enter special characters by pressing the **#** and ***** keys.

- Press **#** to cycle through the special characters **# & ' , - . @** (in that order).
- Press ***** to cycle through the special characters **! () * + ?** (in that order).

Using the Speakerphone

When the speakerphone is active, the **SPEAKER** key is backlit.

To use the speakerphone:

1. To initiate a call, press **SPEAKER**. The key becomes backlit and you hear a dial tone. Begin dialing.
2. To end a call, press **SPEAKER**. The key backlight goes out.

During an active call, if you are using the corded handset or any corded or Cordless Headset, pressing **SPEAKER** switches audio to the speakerphone. If the corded handset is not "hung up," pressing **SPEAKER** switches audio between the corded handset and the speakerphone.

Using Help Screens

In addition to the brief Help messages at the bottom of each screen, you can view more Help on the Deskset screen. These are very brief descriptions of how to use some of the features.

To use the Deskset Help:

1. Press **HELP**. The Help menu appears. (Call Appearance mode shown. The Help menu in Line Appearance mode is slightly different.)

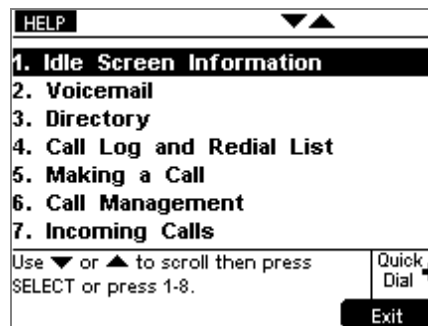

2. Press \triangle or ∇ to highlight the desired feature.
3. Press **SELECT**.
4. Press **Exit** to exit the Help.



About the Auto Attendant



This section applies to Call Appearance mode only.

NOTE

When set to Call Appearance mode, the Synapse system features an Auto Attendant that transfers incoming calls to a pre-recorded menu (guiding callers to the desired extension) or directly to a Synapse extension or extensions. The targets for these transfers may depend on the time of day.

The Auto Attendant may be set up so that callers can access the Auto Attendant directory. This allows callers to use any touch-tone phone's dial pad to spell your name, followed by pressing the pound (#) sign, to reach your extension.

You may want to give your extension number to frequent callers so they can easily dial your extension number when the Auto Attendant answers and asks the caller to enter your extension or to spell your name using the dial-pad keys.

When the Auto Attendant is disabled, all outside calls go to the system operator or to a target that the system administrator assigns, which could be a group of extensions.

Caller Options

Until callers get through to a live person, they can press **0** at any time to redirect their call to the system operator, if the system administrator has enabled this feature.

When a caller is redirected to Voicemail, the caller has the option to press **5** to skip the greeting.

If your system administrator has set up Direct Inward Dialing, callers can dial the Direct Inward Dial telephone number to reach you directly, bypassing the Auto Attendant. Your callers can also call your company's main number and be transferred to your extension.



SB67040 Cordless Handset (Optional)

The optional Cordless Handset, shown in Figure 13, supports most functions of the Deskset in Call Appearance mode, including hands-free speakerphone, once it is registered to your Deskset. Use your Deskset to register your Cordless Handset. See ["Registering an Optional Cordless Handset" on page 185](#).

**NOTE**

The Cordless Handset cannot be used in Line Appearance mode. When the Synapse system is in Line Appearance mode, you cannot register the Cordless Handset to your Deskset.



Figure 13. SB67040 Cordless Handset



Cordless Handset Description

The Handset external features are shown in Figure 14 and [Figure 15 on page 28](#) and described in [Table 9](#) and [Table 10 on page 28](#).

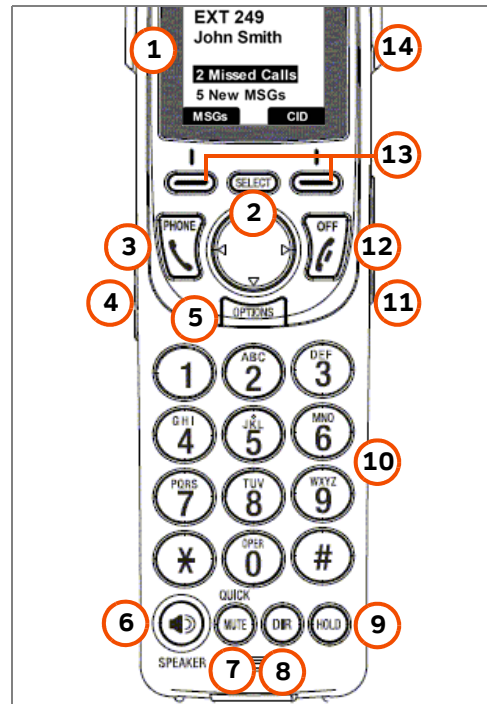

Figure 14. Handset Key Functions

Table 9 Handset Key Functions

1. Liquid Crystal Display (LCD)	Provides instructions and status information.
2. SELECT	Selects an option from a menu or list on the LCD.
3. PHONE	Starts or answers a call.
4. Headset Jack (on side)	Lift the rubber flap to connect an optional corded headset with 2.5 mm plug.
5. OPTIONS	Accesses options depending on the current mode.
6. SPEAKER	Starts or answers a call in Idle mode. During a call, switches audio to and from speakerphone.
7. MUTE/QUICK	Mutes the Handset microphone while on an active or conference call. Press and hold to use Quick-Dial numbers.
8. DIR	Accesses the Directory.
9. HOLD	Puts active call on hold.
10. Dial Pad, 0–9, *, #	Dials, performs shortcuts, or accesses areas in a list.
11. ◀ VOLUME ▶ (on side)	Decreases and increases the ringer or voice volume.
12. OFF	Ends current call.
13. Soft Keys	Labels in the display change according to the current task.
14. Belt Clip	Attaches here.



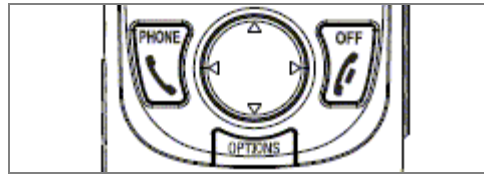

Figure 15. Navigation Key

Table 10 Navigation Key Functions

Arrow	Action
◀	<ul style="list-style-type: none"> ■ Scrolls or cycles through list entries. ■ Performs backspace function. ■ Use during message playback to jump back eight seconds in message. ■ Adjusts display contrast level.
▶	<ul style="list-style-type: none"> ■ Scrolls or cycles through list entries. ■ Use during message playback to jump forward eight seconds in message. ■ Adjusts display contrast level.
△	<ul style="list-style-type: none"> ■ Scrolls through list entries. ■ Highlights new messages or new calls in Idle mode. ■ Use during message playback to play previously numbered message.
▽	<ul style="list-style-type: none"> ■ Scrolls through list entries. ■ Highlights new messages or new calls in Idle mode. ■ Use during message playback to play next numbered message.



Cordless Handset Liquid Crystal Display (LCD)

The Idle screen appears when the Handset has no active or held calls. Figure 16 and Table 11 show and describe the Handset Idle screen.

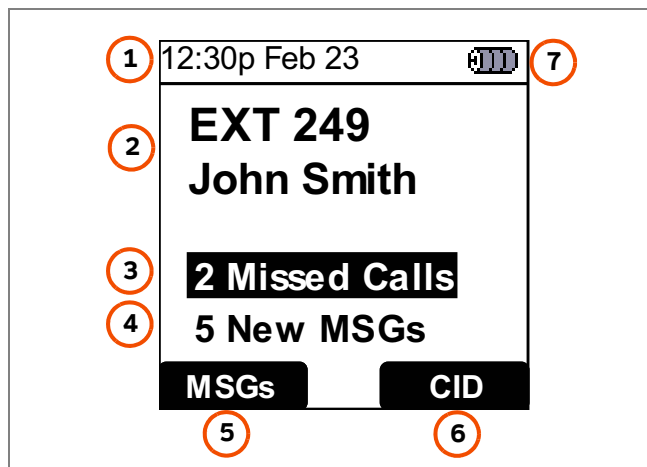

Figure 16. Handset Idle Screen

Table 11 Handset Idle Screen

1. Time and Date

2. Extension Number and Name

The extension number and name for this Handset.

3. New Missed Calls

Number of new missed calls. Press **SELECT** when highlighted to see the missed-calls list.

4. New Messages

Number of new messages. Press **SELECT** when highlighted to see a Message Review screen similar to the one shown on [page 147](#). Once a new message is reviewed, the new message count goes down by one.

5. MSGs

Press the key below this soft key label to see the Message Review screen. See ["Retrieving Personal Voicemail with the Cordless Handset" on page 147](#).

6. CID

Press the key below this soft key label to see the entire Call Log. See ["Using the Call Log with the Cordless Handset" on page 161](#).

7. Handset status

Status for Battery, Do Not Disturb, or Call Forward, and Voicemail memory full.



NOTE

The Handset updates its status during use. There is a brief delay and the Handset screen goes blank. The Handset does not respond to key presses during this update process.

The Handset provides other types of screens to assist you, as shown in Table 12.



Table 12 Cordless Handset Screen Types

Incoming Call Screen	The highlighted entry displays name and number (if available). The other entries for additional incoming calls display name only.
List Screen	List screens display a name and phone number for each entry. A Call Log entry also displays the time called. Press Δ or ∇ to view other entries. The left and right arrows on either side of the name in Call Log entries indicate that you can press \triangleleft or \triangleright to view dialing options.
Confirmation Screen	Confirmation screens require that you confirm a choice by pressing YES or NO .
Menu Screen	Menu screens display lists of choices you can make. To access items in the Handset menus, you can either highlight the function and press SELECT or press a dial-pad key. The procedures in this guide use the dial-pad entry as the preferred method for selecting a function.
Notification Screens	Notification screens alert you that an action has been completed, provide a status update, or give a warning.

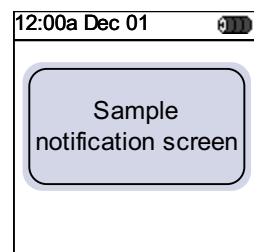
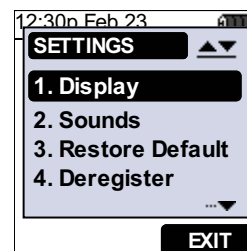
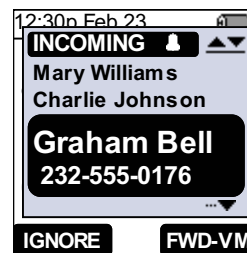













Cordless Handset Soft Keys

The Handset provides soft keys as illustrated in [Figure 16 on page 29](#). The Handset soft keys provide a variety of functions determined by the current action. If you are forwarding a call, for example, the soft keys displayed are different from those displayed if you are making a call. See ["Appendix A: Soft Keys" on page 247](#) for an alphabetical list of the labels that appear above the soft keys.

Cordless Handset Screen Icons

The Handset screen icons indicate Handset activity. Table 13 lists and describes the screen icons you might see.

Table 13 Cordless Handset Screen Icons

Icon	Function	Description
	Navigate up or down list	Indicates that you can press \triangle or ∇ to highlight a list entry.
	Incoming ring or ringer on	Appears during an incoming call, or when you adjust the ringer volume.
	Silenced incoming ring or ringer silenced (muted)	Appears during an incoming call, or when you have set the ringer volume to Off.
	Active call (off hook)	Present during an active call.
	Conference	Present during a conference call.
	Call on hold	Appears when a call is put on hold.
	Conference on hold	Appears when a conference call is put on hold.
	Speaker or page	Appears when you switch to speakerphone or when paging.
	Headset in use	Appears when a Headset is on a call.
	Voicemail message	Appears in the Call Log to indicate that a caller has left a Voicemail message.
	Message playback navigation	Present during message playback to indicate that there are additional messages before or after this one.
	Deskset in use	Appears when the Deskset is off hook.



Using the Cordless Handset Speakerphone

When the speakerphone is active, the **SPEAKER** key is lit. In Idle or Dial mode, this key behaves like **PHONE**, except that audio is from the speakerphone.

To use the speakerphone:

- To initiate a call, press **SPEAKER**. The key becomes lit, you hear a dial tone, and the active call screen appears. You can dial.

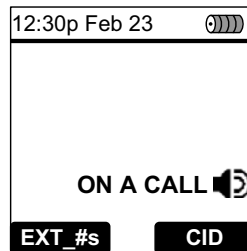

- To end a call, press **OFF**. Pressing **SPEAKER** does not hang up calls. The key backlight goes out and the Idle screen shown in [Figure 16 on page 29](#) appears.
- During an active call, pressing **SPEAKER** switches audio between the Handset and the speakerphone.

Switching Between Deskset and Cordless Handset

When you are on a call at a Deskset and you need to move away from the Deskset, switch the call to the Cordless Handset.

To switch a call from Deskset to Handset:

1. On the Handset, press **PHONE**. The Deskset-in-use notification screen appears.

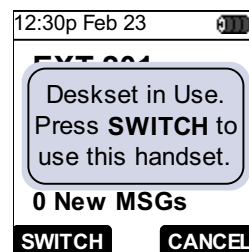

2. Press **SWITCH** on the Handset.

To switch a call from Handset to Deskset:

1. On the Deskset, press the lit Call Appearance key, or press **SPEAKER**.



Deskset/SB67040 Cordless Handset Comparison

The following Deskset features are limited on the Handset:

Paging	You can send pages only to all extensions (not to Paging Zones) from the Cordless Handset, but you cannot receive them. See "Paging with the Cordless Handset" on page 169 . If your Synapse system includes an optional Overhead Paging (OHP) system, you cannot send pages through it.
View other held calls	You can view one held call at a time on the LCD. See "Managing Held Calls" on page 90 . On the Deskset, held calls are listed on the screen.
View simultaneous incoming calls	You can view simultaneous incoming calls one at a time. See "Multiple Incoming Calls" on page 69 . On the Deskset, multiple incoming calls are listed on the screen.
View Voicemail list	You can view one Voicemail record at a time. See "Retrieving Personal Voicemail with the Cordless Handset" on page 147 . On the Deskset, Voicemail records are listed on the screen.
Forward message to extension	You can forward messages to an extension, but with limited functionality. See "To forward a message:" on page 150 . On the Deskset, you can add an introductory message and forward a message to multiple extensions.
Directory	You can access the Directory and choose to see All, Personal, System, or Extension lists, but you cannot change the sort order or create new Personal Directory entries. See "Accessing the Directory with the Cordless Handset" on page 124 .
Speakerphone Key	You can route audio to or from the speakerphone and pick up calls by pressing SPEAKER , but SPEAKER does not hang up calls. See "Using the Cordless Handset Speakerphone" on page 32 .



In addition, the following Deskset features are **not** available on the Handset:

- Operation in Line Appearance mode
- Extension Status
- Record a Voicemail greeting
- Copy Call Log entries or Redial numbers into your Personal Directory list
- Create, edit, or delete your Personal Directory list
- Program Quick-Dial entries
- Call screening
- Auto Answer
- Access to Group Mailboxes
- Turning DND and Call Forward All on or off
- Voicemail Distribution
- Audible Ring Delay
- Ring Group icon
- Call Queue.



Deskset-Handset Interaction

This section identifies similarities and operating interactions between the Deskset and the optional SB67040 Cordless Handset in Call Appearance mode.

Answering a Call While Another Device is on a Call

The Deskset, Cordless Handset, and Cordless Headset all share the same extension number. If there is an active call, it must be put on hold before other calls can be made or answered by one of the other extension devices. You must also switch control to the device you want to use.

Incoming Calls

Incoming Calls appear on the Deskset and Cordless Handset, and both devices ring. If one device answers the call, the other device stops ringing but its Call Appearance indicators reflect the status of the call. This behavior allows an additional incoming call to appear on either device. If there is a subsequent incoming call, the device currently on an active call emits an abbreviated ringtone but the other device does not.

Held Calls

Both the Handset and Deskset display held calls. The Deskset shows held calls in the Call Appearance screen. The Handset displays the current held call with an option to view other calls (see [“Call Management” on page 72](#)) by pressing \triangle or ∇ . When there are held calls, either device can retrieve a held call.

Clocks

The Handset and the Deskset show the current date and time. The clocks on each of the devices run independently, and the system updates the real time frequently. Because the clocks are independent, there may be occasions when the time shown on each is slightly different.

Status

The Handset and the Deskset show the current DND and Call Forward All status. They also show the same notifications for new calls and new messages. This status is broadcast from the Deskset to the Cordless Handset as new events occur. This ensures the Handset status remains the same as the Deskset status.



Cordless Handset Battery Charging

Place the Handset in the charger when not in use. When fully charged, the Handset battery provides approximately five hours of talk time or three days of standby time.

To charge the Handset battery:

1. Place the Handset in the charger.
 - The **CHARGE** light is on when the Handset is charging.

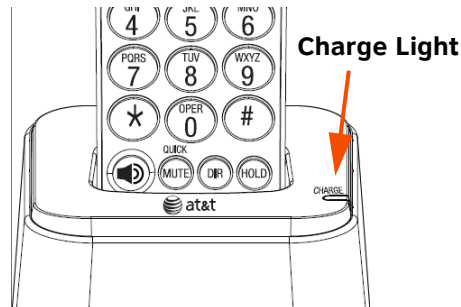

- If the Handset has not yet been registered, the **Register** screen appears within 15 seconds.



Follow the directions on the screen to register the Handset to a Deskset. See [“Registering an Optional Cordless Handset” on page 185](#).

Cordless Handset Low Battery Notification

When the battery is low, the Handset emits an alert tone and displays the **Low Battery** notification screen as shown in Figure 17.

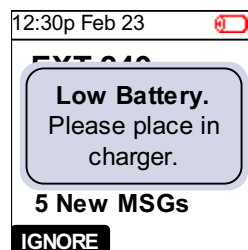

Figure 17. Low Battery Warning

To respond to low battery notification:

1. Press **IGNORE** to exit the notification screen.
2. Place the Handset into the charger.



NOTE

If the Handset stops working when you are on a call because of low battery charge, that call is automatically held on the Deskset.

Power-Save Mode

If you are not on an active call and press no keys for 30 seconds, the screen backlight turns off to save power. Press any key to turn the backlight on.



Cordless Handset Connection Loss Notification

If the Handset leaves the operating range of the Deskset, or if there is radio frequency (RF) interference, a **Lost connection with Deskset** notification screen appears, as shown in Figure 18, and the Handset searches for the Deskset. If the Deskset is not found within five seconds, the **Searching for Deskset...** notification screen appears. If you see either of these screens, move closer to the Deskset.

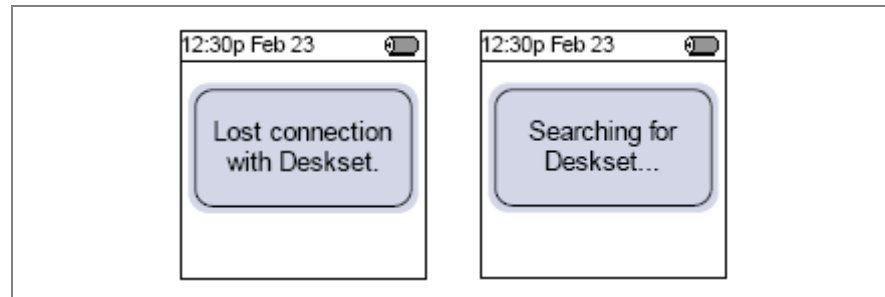

Figure 18. Connection Loss Notification Screens

If you are on a call when you lose the connection, the call is put on hold. When you reestablish the connection, you can take the call off hold and continue the conversation.

Searching a List Using the Cordless Handset Dial Pad

To search for a list entry:

1. Press **DIR** to display the Directory.

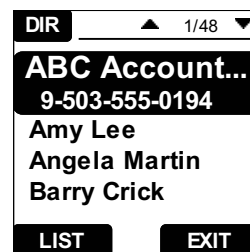

OR

Press **OPTIONS**, then **4** to display the Extension list.

2. Pressing a dial-pad key causes a letter to display in the center of the Handset screen. See [“Dial-Pad Entry” on page 39](#) for more information on dial-pad keys. The Handset finds a name that begins with that letter. If there is no name starting with that letter, the Handset finds the next name in the alphabet. For example:
 - You press **5** twice to enter **K**. If an exact match is found, the highlight bar moves to that entry.
 - You press **5** three times to enter **L**. If the Handset cannot find an exact match, the highlight bar moves to the entry with the next closest alphabetical match.



Dial-Pad Entry

Use the dial-pad keys to enter alphabetical characters to search the Directory and Extension lists. See ["Accessing and Managing Items in Lists with the Cordless Handset" on page 110](#). Keys **2**, **3**, **4**, **5**, **6**, and **8** have three assigned letters, while keys **7** and **9** have four assigned letters. The keys function as follows:

1. Pressing the key once displays names starting with the first letter on the key.
2. Pressing the key twice displays names starting with the second letter.
3. Pressing the key three displays names starting with enters the third letter.
4. Pressing the key four times displays names starting with the number, or the fourth letter for keys **7** and **9**.
5. Pressing the key further cycles through the letters again.

You can enter special characters by pressing the **#** and ***** keys.

- Press **#** to cycle through the special characters **# & ' , - . @** (in that order).
- Press ***** to cycle through the special characters **! () * + ?** (in that order).



TL7600 Cordless Headset (Optional)

This optional Cordless Headset, shown in Figure 19, provides a 500-foot range and easy one-button answering once it is registered to your Deskset. Use your Deskset to register your Cordless Headset. See ["To register the TL7600 Cordless Headset:" on page 186.](#)



Figure 19. Optional TL7600 Cordless Headset

Cordless Headset Description



NOTE

The registration process described in the manual that comes with the Cordless Headset is not appropriate for the Deskset, which requires a different process. The correct process is described in ["To register the TL7600 Cordless Headset:"](#) on page 186.

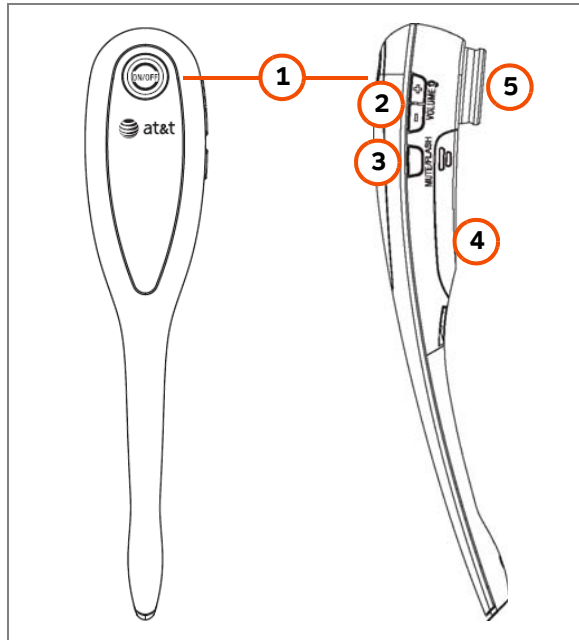



Figure 20. TL7600 Cordless Headset Features

- | | |
|-------------------------|---|
| 1. ON/OFF | <p>Press to make or answer a call, and to end a call.</p> <p>The light is on when the Headset is charging in the Headset charger.</p> <p>The light flashes slowly when you are on a call and flashes quickly when there is an incoming call.</p> <p>NOTE: To answer a call while you are already on a call, press ON/OFF. The first call is dropped. Press ON/OFF to answer the next call.</p> |
| 2. VOLUME +/- | <p>Press the volume key on the side of the Headset to adjust the listening volume when on a call.</p> |
| 3. MUTE/FLASH | <p>Press to mute the microphone during a call. The Headset beeps every 10 or 15 seconds while you are on hold.</p> <p>Press to mute the ringtone in the earpiece when there is an incoming call.</p> <p>FLASH is inoperative with the SB67030/031 Deskset.</p> |
| 4. Battery Cover | <p>Open to install or replace the battery.</p> |
| 5. Earpiece | <p>When you receive calls, the Headset earpiece plays a ringtone. The Headset does not have an external ringer.</p> |



Cordless Headset Operation

Table 14 TL7600 Cordless Headset Operation

Function	Operation
Ringtone silencing	Press MUTE/FLASH to temporarily silence the ringtone in the Headset earpiece. This silences the ringtone without disconnecting the call. The next incoming call rings normally at the preset volume.
Volume control	While on a call, use the VOLUME +/- keys on the side of the Headset to adjust the listening volume.
Mute	Press MUTE/FLASH to turn the Headset microphone on or off. When mute is on, there is a short beep every 10 or 15 seconds until mute is turned off. The SB67030/031 Deskset does not support the flash feature.
	 The MUTE button on the Deskset does not mute the Cordless Headset. NOTE
Answering a call	Press ON/OFF on the Headset.
Ending a call	Press ON/OFF on the Headset.
Auto off	A call ends automatically when you put the Headset in the charger.
Alert tones	You hear three short beeps when: <ul style="list-style-type: none"> ■ VOLUME +/- keys are pressed when the volume is already at its highest or lowest setting. ■ The Headset is not registered and the Headset ON/OFF button was pressed. ■ The Headset has gone out of range from the Deskset during a call.
Low battery warning	You hear 1 short beep every 20 seconds when the battery is low.
Key beep	You hear 1 short beep when pressing the Headset ON/OFF key to start or end a call.
ON/OFF light status	<p>On — Headset is registered to the Deskset and is charging in the Headset charger.</p> <hr/> <p>Flashes quickly — There is an incoming call.</p> <hr/> <p>Flashes three times followed by a pause — The battery level is very low. The cycle repeats three more times before the headset shuts down.</p> <hr/> <p>Flashes twice in orange and blue every five seconds — The Headset is not registered.</p> <hr/> <p>Flashes every 20 seconds — The battery is low and needs to be charged in the Headset charger.</p> <hr/> <p>Flashes every three seconds — The Headset is in use.</p>





CHAPTER
2

OUTGOING CALLS

The Deskset and the optional SB67040 Cordless Handset provide several methods for making a call. You can also use the optional TL7600 Cordless Headset to complete a call that you dialed on the Deskset or Cordless Handset.

If you are in Idle mode or have calls on hold, you can predial a phone number and then go off hook to call the number. You can make a call at any time by choosing an off-hook method, then dialing a number. This is referred to as Live Dialing. You can also predial or live dial using phone numbers from lists, such as the Directory, Call Log, Redial, Quick Dial, and Messages.

In Call Appearance mode, you can dial the extension for the system operator by pressing **0** (zero).

The procedures in this chapter apply to both Call Appearance and Line Appearance mode, unless otherwise noted.

- ["Active Call Screen" on page 44](#)
- ["Predialing" on page 45](#)
- ["Live Dialing" on page 46](#)
- ["Making a Call from a List" on page 47](#)
- ["Calling a Busy Extension" on page 48](#)
- ["Making an Intercom Call" on page 49](#)
- ["Calling a Restricted Number" on page 50](#)
- ["Making Calls with the Cordless Handset" on page 52](#)
- ["Making Calls with the Optional TL7600 Cordless Headset" on page 55.](#)



Active Call Screen

The Active Call screen, as shown in Figure 21, appears while you are on a call.

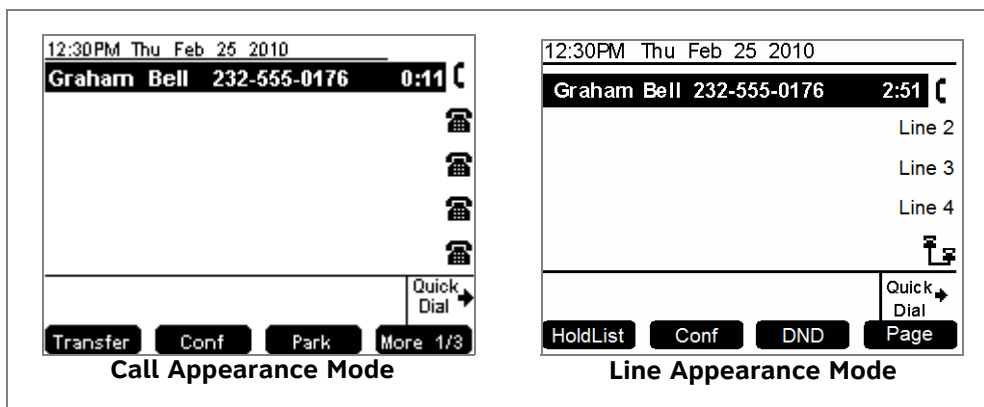

Figure 21. Active Call Screen

Table 16. Active Call Screen Description

Key	Description	Key	Description
Transfer	Call Appearance mode only — Begins transfer of a call.	Conf	Begins a conference call.
Park	Call Appearance mode only — Parks an external call.	Page	Pages all extensions.
DND	Turns Do Not Disturb on or off.	CallFwd	Call Appearance mode only — Turns Call Forward on or off.
ParkList	Call Appearance mode only — Displays the Park list.	More	Call Appearance mode only — Moves to the next set of soft keys. More 1/3 indicates that you are on page one of three.
HoldList	Line Appearance mode only — Displays the Held Calls list.		



Predialing

Predial is only available when the Deskset is idle or when all calls are on hold. In Predial mode, there is no dial tone. You can only predial one phone number at a time. To begin Predial, press a dial-pad key.

To make a Predial call:

1. Enter an extension number or phone number (for example: **9-1-232-555-0176**) using the dial pad. The predial screen appears (Call Appearance mode shown).

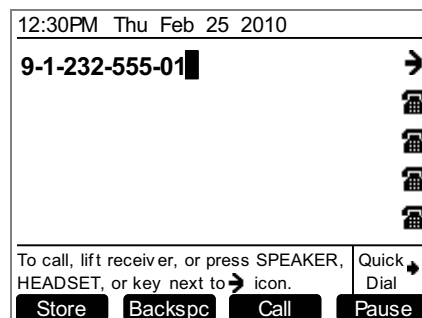

Call Appearance mode only — For outside calls, dial **9** or whatever digit, if any, that must be dialed first. The hyphens appear automatically.

Before you call the number, you can press:

- **Store** to store the number in your Personal list.
 - **Backspc** to delete the last digit entered.
 - **Pause** to insert a two-second pause into the phone number.
 - **CANCEL** to cancel predial.
2. Lift the corded handset, or press **SPEAKER, HEADSET, Call**, or a Call Appearance or Line Appearance key to go off hook and call the number.

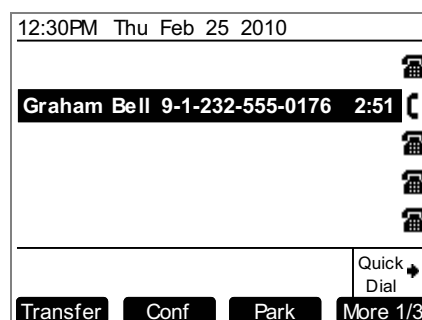

When you predial more digits than can be displayed, the digits move to the left so that the most recently dialed digits can be seen. Three dots appear to indicate that the earliest digits are no longer visible.

To do this with the Cordless Handset, see ["Predialing" on page 53](#).



Live Dialing

You can make a call by going off hook, then dialing a phone number.

To dial a live number:

- Do one of the following to go off hook (to hear the dial tone) from Idle mode:
 - Lift the corded handset.
 - Press **SPEAKER** or **HEADSET**.
 - Press an available Call Appearance or Line Appearance key.
- Enter the extension number or phone number you want to dial, as shown below (Call Appearance mode shown).

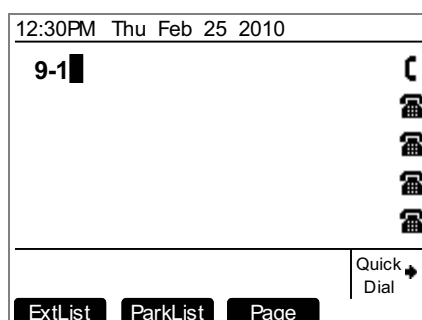

- Call Appearance mode only** — For outside calls, enter **9** or whatever digit, if any, that must be dialed first.
- Hyphens are automatically inserted except when whatever digit, if any, that must be dialed for outside calls is followed by a **0** for an outgoing international call.
- When you dial more digits than can be displayed, the digits move to the left so that the most recently dialed digits can be seen. Three dots indicate that the first digits are no longer visible.

The Active Call screen appears (Call Appearance mode shown).

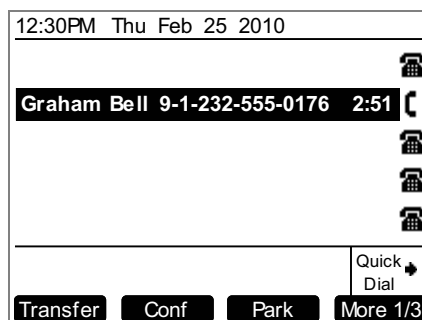

To do this with the Cordless Handset, see [“Live Dialing” on page 54](#).



Making a Call from a List

To make a call from a list:

1. Access the desired list entry. For example, press **DIRECTORY**. The **Directory** screen appears. See ["Accessing Items in Lists"](#) on page 96.

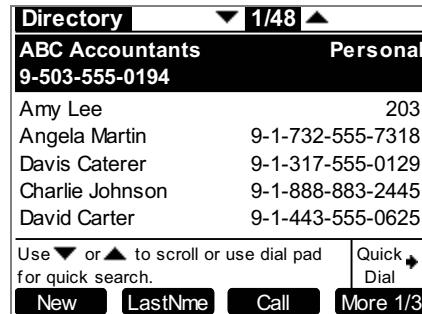

2. Press \triangle or ∇ until you highlight the desired entry.
3. Press **Call** or **SELECT** to dial the highlighted number. The Deskset dials the number and the Active Call screen appears (Call Appearance mode shown).

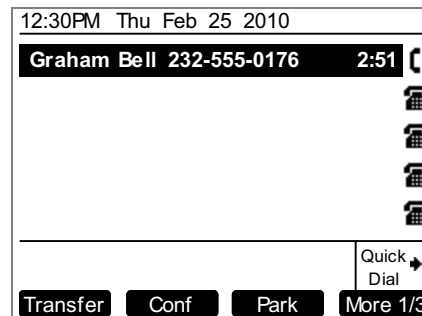

Phone numbers are dialed as they appear in the lists. **Call Appearance mode only** — For outside calls, enter **9** or whatever digit, if any, that must be dialed before the phone number. When you dial from the Call Log, any required outside calling prefix digit is automatically added.



Calling a Busy Extension

If you call an extension that is on a call or busy, your Deskset displays an Extension Status screen, shown in Figure 22. The Extension Status screen notifies you that the other party may not be available to answer your call. When the Extension Status screen appears, you can choose to call the other Deskset anyway, or go directly to the Deskset's voicemail.



The Extension Status screen applies to internal calls in Call Appearance mode only. The Extension Status does not appear on the Cordless Handset.

If the person you are calling is on an active call or is paging, the Extension Status reads **on a call**.

If the other extension has Do Not Disturb ON, the Extension Status reads **Busy**.

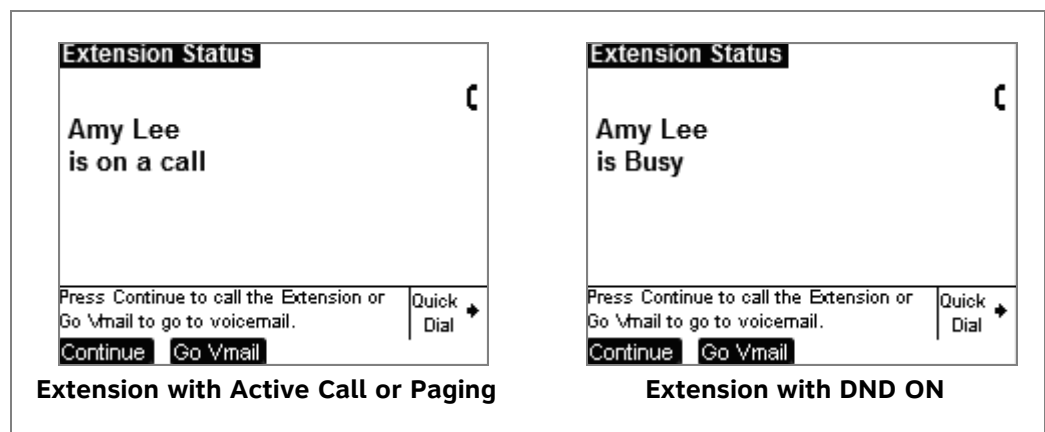

Figure 22. Extension Status Screens

When the Extension Status screen appears, you can press:

- **Continue** to call the other extension. Your incoming call appears on the other Deskset's screen, and the other party can answer your call if they wish.
- **Go Vmail** to go directly to the other extension's Personal Mailbox. If you leave a message, the other extension displays a New Message notification on the Deskset Idle screen.
- **CANCEL** or hang up using the handset or **SPEAKER** key to return your Deskset to the previous screen.



Making an Intercom Call



Intercom Calls apply to Line Appearance mode only.

NOTE

In Line Appearance mode, your Deskset uses an outside line any time you go off hook by lifting the handset, pressing **SPEAKER**, or by some other method. To make an internal (extension-to-extension) call, you must press the **INTERCOM** key as shown in [Figure 11 on page 20](#). By default, key 5 is the Intercom key, but your system administrator can configure additional Intercom keys to give you more Intercom lines.

To make an intercom call:

1. With the Deskset in Idle mode, go off hook by lifting the handset, pressing **SPEAKER**, or by some other method.
2. Press the **INTERCOM** key, then dial the extension number.

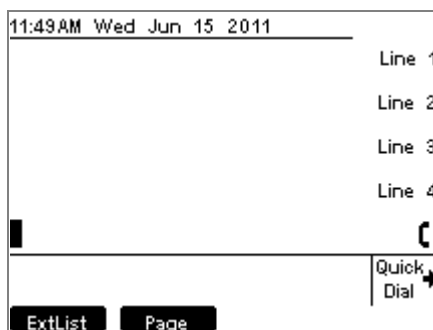

Instead of dialing after pressing the **INTERCOM** key, you can press **ExtList**, highlight the desired extension number, then press **Call** or **SELECT** to dial the number.

3. When your Intercom call is answered, the Active Call screen appears.

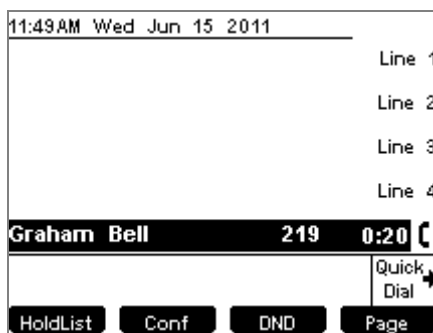

Calling a Restricted Number



Call Restriction Settings apply to Call Appearance mode only.

NOTE

Your system administrator can configure Call Restriction settings that may prohibit you from making calls to certain types of numbers — international long-distance numbers, for example.

Call Restriction settings are specific to each extension in the system. For example, your extension may have no call restrictions, but other users may be restricted to making only local calls from their Desksets.

You can always answer and transfer incoming calls from restricted numbers.

To call a restricted number, you must create a User Password on the User Settings menu or the WebUI. To create a User Password, see [“Setting and Changing Your Password” on page 191](#) or [“Basic Settings” on page 206](#).

Calling Restricted Numbers on Your Extension

You cannot complete a call to a number that the system administrator restricted for your Deskset. If you dial a restricted number and go off hook, a password screen appears. After you enter your extension number and password, the **Restricted Call** screen appears, as shown in Figure 23.

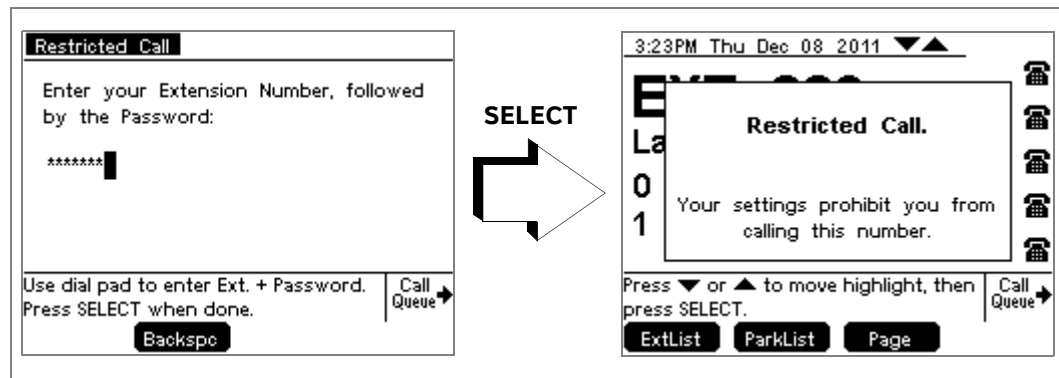

Figure 23. Restricted Call

You can press **CANCEL** or hang up to return to the Idle screen immediately.



Calling Restricted Numbers Using Another Extension

If you need to use someone else's Deskset to call a number that is restricted on that Deskset, you can enter your Extension number and User Password to complete the call.

To make a restricted call:

1. On a Synapse Deskset other than your own, dial the number as described in ["Predialing" on page 45](#) or ["Live Dialing" on page 46](#).

If the number is restricted on the Deskset, the **Restricted Call** screen appears as shown in Figure 23.

2. Enter your own extension number and user password.

If the dialed number is not restricted for your extension number, the Deskset dials the number.



Making Calls with the Cordless Handset

You can also make calls with the optional SB67040 Cordless Handset.



Cordless Handset operation is compatible with Call Appearance mode only.

Active Call Screen

The Active Call screen, as shown in Figure 24, appears while you are on a call.

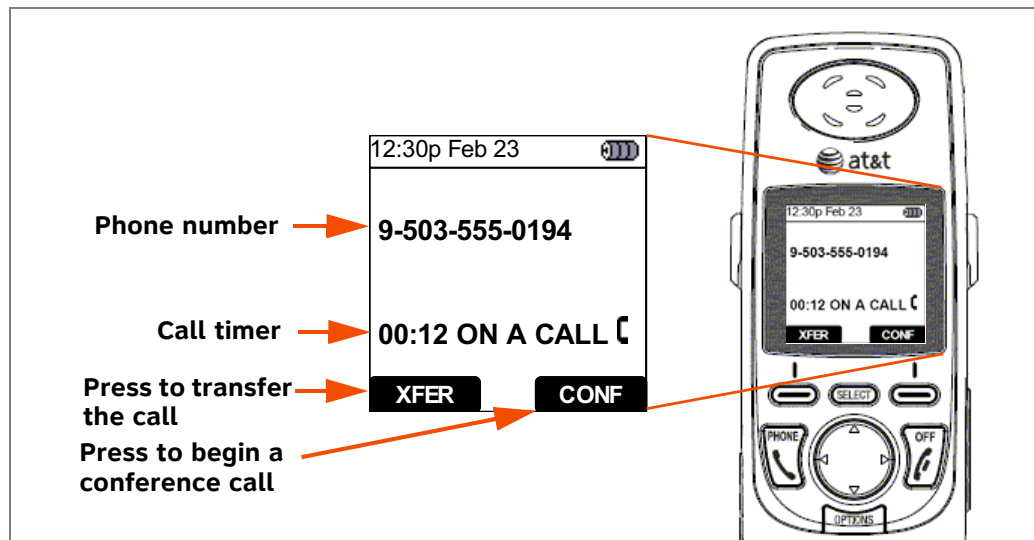

Figure 24. Active Call Screen



Predialing

You can dial a phone number before pressing **PHONE** or **SPEAKER**. Pressing a dial-pad key begins Predial mode. In this mode, the Handset produces no dial tone. You can also predial from a list.

To Predial a call:

1. Enter the phone number using the dial-pad. (For outside calls, dial **9** or whatever digit, if any, that must be dialed first).

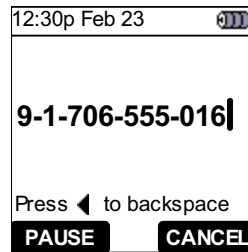

OR

Access a phone number from any of the lists described in [“Accessing and Managing Items in Lists with the Cordless Handset” on page 110](#).



For outside phone numbers in Voicemail and CID (Call Log) lists, Synapse dials whatever digit, if any, must be dialed first and then dials the number in the display. Therefore, numbers that need editing (adding a preceding 1 or a country code, or removing the area code) cannot be dialed from Voicemail.

Before you call the number, you can press:

- The  to delete a digit and move the cursor back one space.
 - **PAUSE** to insert a two-second pause. The pause appears as a **P** in the phone number.
 - **OFF** or **CANCEL** to clear all digits. The Idle screen appears.
2. Press **PHONE** or **SPEAKER** to dial the Predial digits.



Live Dialing

Live dialing refers to dialing when the phone is already off hook (when there is already a dial tone).

To make a call off hook:

1. Press **PHONE** or **SPEAKER** to start a call.

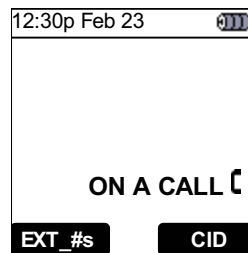

You are now off hook and hear a dial tone.

2. Enter the number you want to dial. (For outside calls, dial **9** or whatever digit, if any, that must be dialed first).

OR

Access a phone number from any of the lists described in [“Accessing and Managing Items in Lists with the Cordless Handset” on page 110](#).



NOTE

For outside phone numbers in Voicemail and CID lists, Synapse dials whatever digit, if any, that must be dialed first and then dials the number in the display. Therefore, numbers that need editing (adding a preceding 1 or a country code, or removing the area code) cannot be dialed from Voicemail.

The Active Call screen appears.

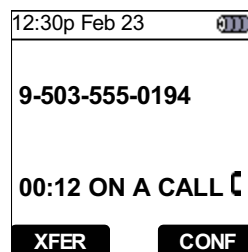

NOTE

Hyphens are automatically inserted except when whatever digit, if any, that must be dialed for outside calls is followed by a 0 (zero) for an international call.



Making Calls with the Optional TL7600 Cordless Headset

If you have an optional TL7600 Cordless Headset registered to your Deskset, then you can make calls with the Headset. Use the Deskset dial pad to dial the number.

To make a call with the Cordless Headset:

1. Press **ON/OFF** on the Headset. The Headset is active when you hear a dial tone.

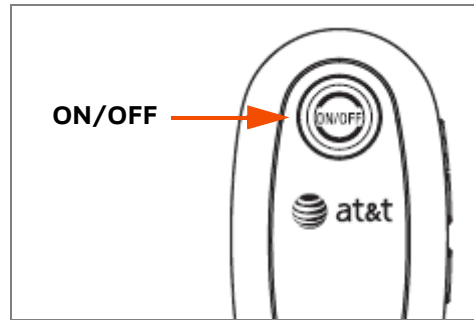

2. Dial the extension or phone number on the Deskset.
3. Press **on/OFF** on the Headset to end the call.

OR

1. Pre-dial the extension or phone number on the Deskset or optional Cordless Handset.
2. Press **ON/off** on the Headset to initiate dialing and transfer the audio to the Headset.
3. Press **on/OFF** on the Headset to end the call.



CHAPTER
3

INCOMING CALLS

When a call comes in, the Deskset and the optional SB67040 Cordless Handset ring and the incoming call information appears as shown in [Figure 25 on page 57](#). The screen displays the caller's name and number (if available). If there is more than one incoming call, they are displayed on the five Call Appearances or up to four Line Appearances on the screen. You can answer or ignore each call.

You can also answer calls with the optional TL7600 Cordless Headset. When you hear the ring, press **ON/OFF** on the Headset. If you have an analog telephone such as a conference phone connected via an optional Analog Terminal Adapter (ATA), you can also answer phone calls with that telephone.

The procedures in this chapter apply to both Call Appearance and Line Appearance mode, unless otherwise noted.

The following sections describe handling incoming calls:

- ["Incoming Call Screen" on page 57](#)
- ["Incoming Call Indication" on page 58](#)
- ["Answering a Call" on page 60](#)
- ["Ignoring a Call" on page 61](#)
- ["Call Screening" on page 63](#)
- ["Auto Answering" on page 64](#)
- ["Answering Calls in the Call Queue" on page 65](#)
- ["Answer a Call with the Cordless Handset" on page 67.](#)



Incoming Call Screen

The Incoming Call and Active Call screens are shown in Figure 25.

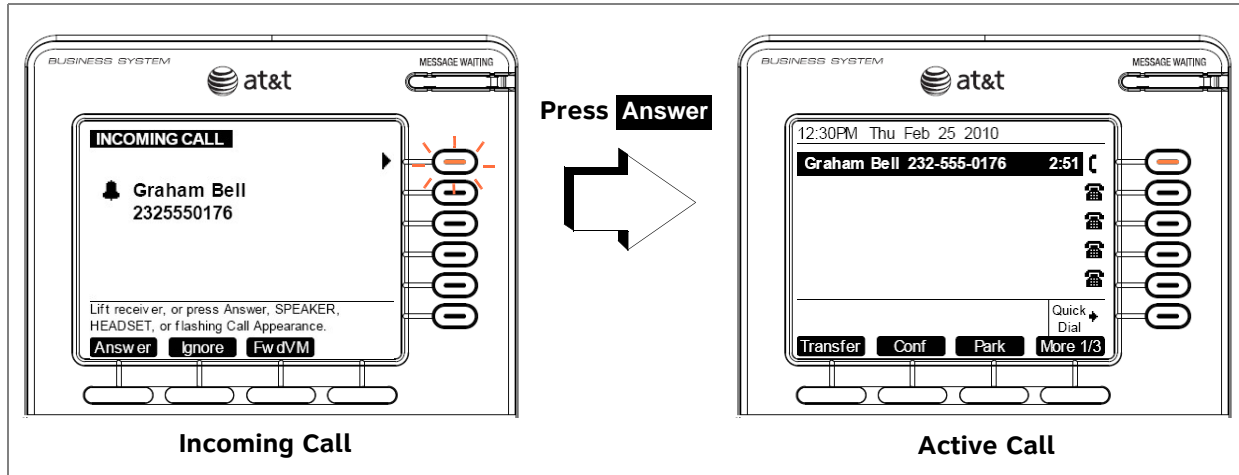

Figure 25. Incoming Call and Active Call

Table 17. Incoming Call Screen Soft Keys

Key	Description
Answer	Answers incoming call.
Ignore	Silences ringer during incoming call.
FwdVM	Call Appearance mode only — Forwards incoming call to Voicemail.



Incoming Call Indication

When there is an incoming call, the Deskset rings. See *"Sounds"* on page 173.



Do Not Disturb and Audible Ring Delay both affect the onset of ringing. See *"Using Do Not Disturb (DND)"* on page 195 and *"Sounds"* on page 173.

Call Appearance Mode

When there are no active or held calls, an Incoming Call screen appears, as shown in Figure 26.

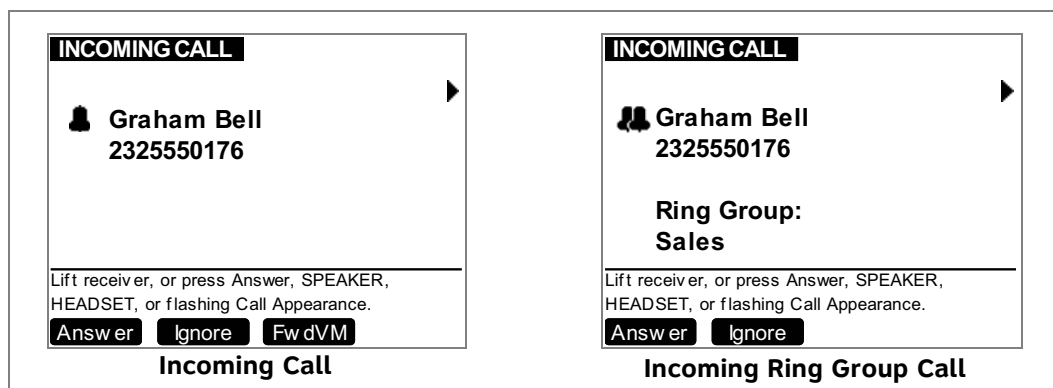

Figure 26. Incoming Call Screens

If your extension is part of a Ring Group, a group of extensions may ring all at once or in a sequence for the same call.

When there are active or held calls, or you are live dialing, an **Incoming Call** screen appears, as shown in Figure 27 or, if it is a Ring Group call, as shown in Figure 27. There is a single, short beep. The incoming call is highlighted and a flashing bell icon appears next to the call information. (Graham Bell is the caller in these figures.) You cannot forward Incoming Ring Group Calls to Voicemail.

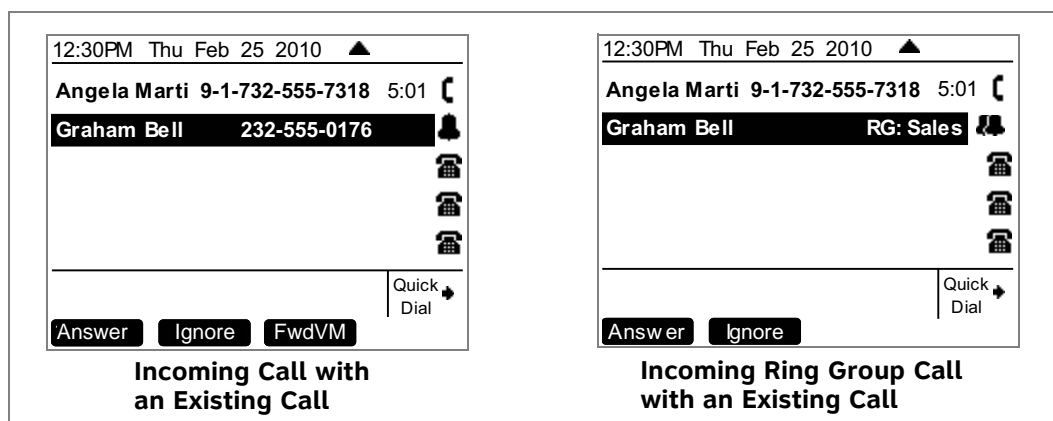

Figure 27. Multiple Incoming Call Screens



If your company has caller ID, the **Incoming Call** screen displays caller information. If the caller ID information is absent because it is unavailable, UNKNOWN NAME and UNKNOWN NUMBER display. If the caller chooses not to send the information, PRIVATE NAME and PRIVATE NUMBER display.

- When there are no available Call Appearances, incoming calls are forwarded according to the Call Forward–No Answer setting customized by the system administrator. The default setting for Call Forward–No Answer is Voicemail.

To see incoming call notifications on the Cordless Handset, see [“Incoming Call Indication” on page 68](#).

Line Appearance Mode

When there are no active or held calls, the incoming call appears as shown in [Figure 26 on page 58](#) (the **FwdVM** soft key does not appear).

If someone at another Deskset answers the call, your Deskset returns to Idle mode.



Answering a Call

To answer a call:

- Lift the corded handset.
- Press **Answer** to answer using the Preferred Audio Mode. See [“Preferred Audio” on page 175](#).
- Press **SPEAKER** to use the speakerphone.
- Press **HEADSET** to use the Cordless Headset or corded headset. See [“Call Management Using a Headset” on page 95](#).
- For multiple incoming calls, press **Answer** or press the corresponding Call Appearance or Line Appearance key to answer each call. You can also press **Ignore** to return the highlight to your active call.

The active call screen appears (Call Appearance mode shown).

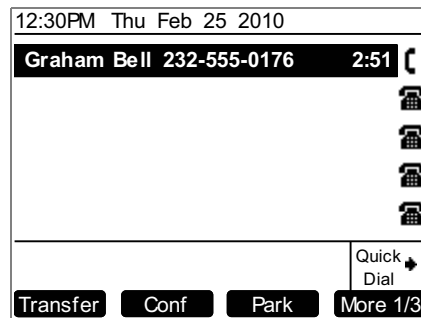

If you are listening to Voicemail when a call comes in, press **Ignore** or (in Call Appearance mode) **FwdVM** to redirect the call and allow message playback to continue.

Call Appearance mode only — If Auto Answer is enabled, the call is automatically answered after the set time delay. See [“Auto Answering” on page 64](#).



Ignoring a Call

You can ignore an incoming call by pressing **Ignore** to silence the ringer. The silenced ringer icon appears, as shown in Figure 28. If you are on an active or held call, after the ignored call has been forwarded, the highlight moves back to whatever call you were on before the incoming call.

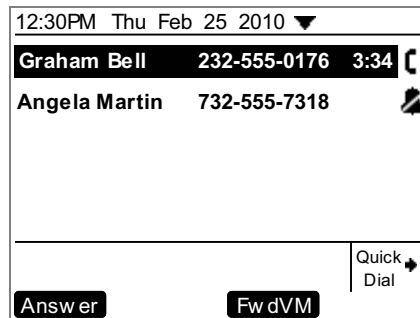

Figure 28. Ignored Call

- Once a call is ignored:
 - The **Ignore** key is no longer available on the incoming call screen.
 - If there is a registered Cordless Handset, it also stops ringing.
 - The Call Appearance or Line Appearance key LED continues to flash.
 - You can press the flashing Call Appearance or Line Appearance key to answer the incoming call.
 - In Line Appearance mode, when you have no other active calls, you can go off hook to answer the ignored call.
- In Call Appearance mode, if an ignored call is highlighted, going off hook does not answer the call, but starts a new call on the next available Call Appearance.



Forwarding All Calls



This feature applies to Call Appearance mode only.

NOTE

You can forward all incoming calls to the destination that you specified in the User Settings. See [“Call Forward All and Call Forward–No Answer” on page 106](#).

To forward all calls:

Press **CallFwd** when the telephone is idle.

- **FWD ON** appears in the upper right corner of the display.
- Press **CallFwd** again to cancel forwarding all calls.



Call Screening



This feature applies to Call Appearance mode only.

NOTE

When an incoming call goes to Voicemail, the Message icon (📧) indicates that recording is in progress. You can listen to the recording in progress and interrupt it at any time by answering the call. If another incoming call occurs while screening a call, the highlight moves to the new call and there is an abbreviated ring.

To screen a call:

If there is more than one active call, press ∇ or \triangle to highlight the call marked with the Message icon.

- Press **Listen** to listen to a message that is being recorded. The **Listen** soft key changes to **Stop**.

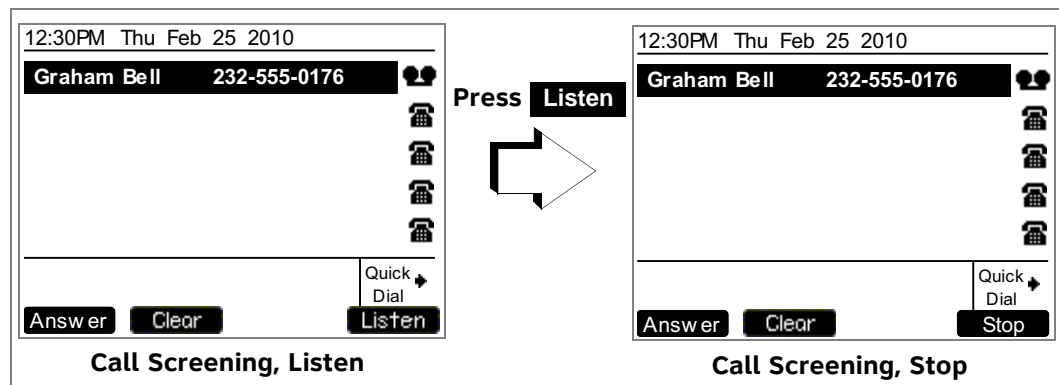

- Press **Answer** to interrupt the recording and talk to the caller.
- Press **Clear** to cancel call screening for this call and return to the previous Call Appearance or the previous screen.
- Press **Stop** to stop listening to the message being recorded.



Call screening is not available on the optional Cordless Handset or Cordless Headset.

NOTE



Auto Answering



This feature applies to Call Appearance mode only.

NOTE

You can set your Deskset to answer calls automatically, without your having to touch the phone to answer. When you enable Auto Answer, **ANS ON** appears at the top of the Deskset screen if **DND ON** and **FWD ON** are not active, since Auto Answer is disabled if they are on.



To respond to an Auto Answered call:

In Idle mode, all incoming calls ring for the amount of time specified in the Auto Answer Delay. See [“Automatic Answering” on page 181](#). After the last ring, a two-second notification screen appears, and you hear a warning tone. Talk after the tone.

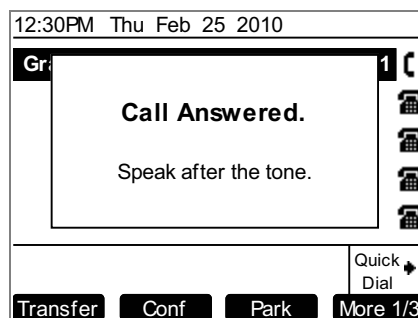

If the Auto Answer Delay is set to zero, you hear no ring. Instead, the **Call Answered** screen appears and you hear the warning tone.

NOTE

If you do not want the Deskset to automatically answer the call, you can press **CANCEL** to send the call to the Call Forward–No Answer target. See [“Call Forward All and Call Forward–No Answer” on page 179](#).

If there are multiple incoming calls, Auto Answer applies to the first (oldest) incoming call. Subsequent incoming calls are handled according to the Call Forward–No Answer setting.

Auto Answer does not apply to Ring Group calls. See [“Incoming Call Indication” on page 58](#).



Answering Calls in the Call Queue



This feature applies to Call Appearance mode only.

Your system administrator may have set up your Deskset as a Call Queue Agent. The key in the bottom right corner will have a **Call Queue** label. Incoming calls are directed to your Deskset and all other assigned Call Queue Agents.

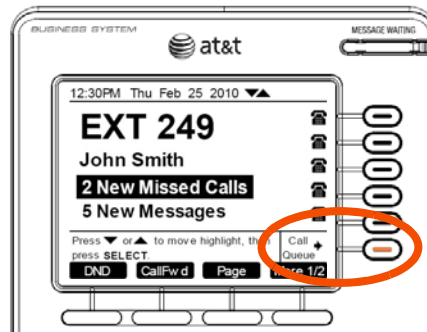

Answering Calls from Idle Mode

When your Deskset is idle, incoming Call Queue calls ring at your extension and at all other idle Call Queue extensions.

To answer a call in the Call Queue:

You can answer these calls as described in [“Answering a Call” on page 60](#).

If no one answers an incoming call from the Call Queue, it rings indefinitely. Call Forward–No Answer rules (see [“Call Forward All and Call Forward–No Answer” on page 179](#)) do not apply to calls that are directed to Call Queue extensions.



Your system administrator can configure a wrap-up time, which defines a period during which your Deskset will not ring for another queued call after you complete a Call Queue call.

Depending on how your system is set up, calls from the Call Queue may ring at your Deskset while you are on a call that isn't from the Call Queue.



Viewing the Queued Calls List

When all Call Queue Agents are busy, incoming calls are held in the Call Queue. The Call Queue key LED flashes orange slowly when calls are waiting in the Call Queue. You can view and answer queued calls from the **Queued Calls** list. For more information, see ["Accessing the Queued Calls List" on page 97](#).

Queued Calls			▼ 1/10 ▲
Graham Bell	232-555-0176	3:01	
Charlie Johnson	212-555-0154	2:58	
Mary Williams	706-555-0162	2:47	
Linda Miller	317-555-0129	2:32	
ABC Accountants	305-555-0134	1:44	
Unknown Caller	443-555-0625	1:24	
Milford Taxi	732-555-7318	0:35	
Use ▼ or ▲ to scroll, then press Retrieve to answer the call.			Call Queue →
Retrieve			



Answer a Call with the Cordless Handset

You can also answer calls with the optional SB67040 Cordless Handset. When the extension receives an incoming call, the Cordless Handset rings and the incoming call information appears as shown at right. The screen displays the caller's name and number (if available).



Cordless Handset operation is compatible with Call Appearance mode only.

To answer the call, press **PHONE**.

This section contains the following:

- [“Answering a Call” on page 69](#)
- [“Multiple Incoming Calls” on page 69.](#)



Incoming Call Indication

Options for an Incoming call:

When there is an incoming call:

- The Cordless Handset rings. See [“Setting the Cordless Handset Ringer and Voice Volume” on page 200](#).
- The incoming call screen appears.

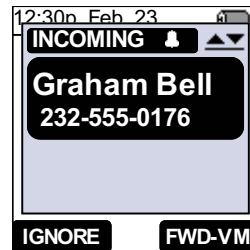

- If you are on an active call or live dialing, there is a single, short ring.
- When there multiple incoming calls, the most recent incoming call is highlighted. Press \triangle or ∇ to switch between the calls or press **IGNORE**. See [“Ignoring a Call” on page 61](#).

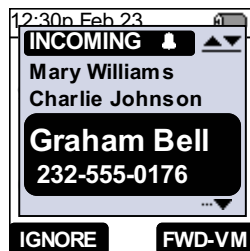

Other actions during incoming calls:

- If there is more than one incoming call, each remains in the display until you press **IGNORE** while the call is highlighted.
- If you are reviewing Voicemail, press **IGNORE** or **FWD-VM** to allow message playback to continue.



NOTE

If the ringer sound is turned off, the incoming call screen still appears.



Answering a Call

When you receive a call while the extension is idle, you can press:

- **SELECT**, **PHONE**, or **SPEAKER** to answer the call.
- **IGNORE** to silence the ringer. You can still answer the call.
- **FWD-VM** to forward the call to Voicemail.



NOTE

Press ◀ **Volume** ▶ while the Cordless Handset is ringing to decrease or increase the ringer volume.

Call screening is not available from the Cordless Handset.

When you receive a call during an active call, you can press:

- **PHONE** or **SELECT** to answer the incoming call. The current call is automatically put on hold.
- **IGNORE** to silence the ringer. You can still answer the call.
- **FWD-VM** to forward the call to Voicemail.
- **SPEAKER** to switch the current call to and from the speakerphone.

Multiple Incoming Calls

If the Cordless Handset receives more than one call at a time, the calls display in a list on the screen. The most recent call is added to the bottom of the list and appears as a two-line name and telephone number. The other pending calls appear in the list as one-line entries, as shown in Figure 29. This screen remains active until you answer one of the calls or until all calls end or are forwarded.

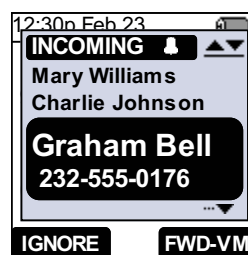

Figure 29. Multiple Incoming Calls

Options during multiple incoming calls:

- Press △ or ▽ to view the incoming calls.
- Press **SELECT**, **PHONE**, or **SPEAKER** to answer the highlighted call.
- Press **IGNORE** to silence the ringer of the highlighted call.
- Press **FWD-VM** to forward the highlighted incoming call to Voicemail.
- Press ◀ **Volume** ▶ to decrease or increase the ringer volume.





NOTE

Unanswered incoming calls are handled according to the Call Forward–No Answer setting.



The system administrator sets the call-forwarding options. For more information on this setting, see the Synapse Administrator's Guide at www.telephones.att.com/synapseguides.



CHAPTER
4

CALL MANAGEMENT

This chapter describes the call management features of the Deskset and optional SB67040 Cordless Handset. The Deskset and Cordless Handset enable you to put calls on hold, transfer calls, park calls, and create conference calls.

Call management features and procedures differ depending on whether your system is in Call Appearance or Line Appearance mode. This chapter describes the differences between the two modes.

- ["Call Management" on page 72](#)
- ["Putting a Call on Hold \(Call Appearance Mode\)" on page 73](#)
- ["Putting a Call on Hold \(Line Appearance Mode\)" on page 74](#)
- ["Transferring a Call" on page 75](#)
- ["Making a Conference Call" on page 78](#)
- ["Parking a Call" on page 81](#)
- ["Call Management Using the Cordless Handset" on page 83](#)
- ["Call Management Using a Headset" on page 95.](#)



Call Management

The Deskset Call Management functions begin with the Active Call screen shown in Figure 30.

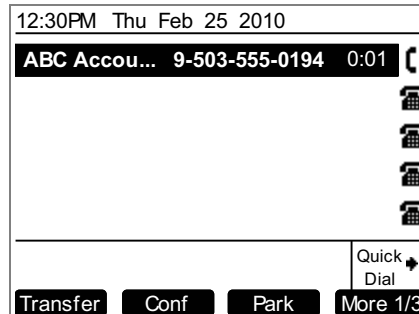

Figure 30. Active Call Screen (Call Appearance Mode Shown)

Table 18. Active Call Screen Description

Key	Description	Key	Description
Transfer	Call Appearance mode only — Begins transfer of a call.	Conf	Begins a conference call.
Park	Call Appearance mode only — Parks an external call.	DND	Turns Do Not Disturb on or off.
CallFwd	Call Appearance mode only — Turns Call Forward on or off.	Page	Pages all extensions.
ParkList	Call Appearance mode only — Accesses Park list.	More	Call Appearance mode only — Moves to the next set of soft keys. More 1/3 indicates that you are on page one of three.
HoldList	Line Appearance mode only — Access the Held Calls list.		



Putting a Call on Hold (Call Appearance Mode)

To hold calls and manage held calls:

- When you are on an active call, press **HOLD**.
 - The Held Call Appearance icon  appears next to the highlighted call.

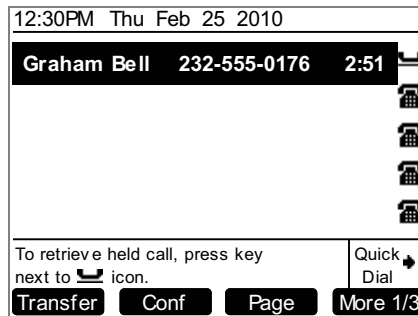

- If a call has been on hold for longer than three minutes, the Deskset reminds you with a brief ring every 30 seconds.
 - When a call is on hold, you can use the Deskset Menu to access other functions.
 - When a call is on hold, you can also press any soft key to perform that action.
- To take the call off hold, highlight the call and press **SELECT**, or press the associated Call Appearance key.



NOTE

Lifting the corded handset, or pressing **SPEAKER** or **HEADSET**, takes you off hook on an idle line; it does not take the highlighted call off hold.

To do this with the Cordless Handset, see ["Managing Held Calls" on page 90](#).



Putting a Call on Hold (Line Appearance Mode)

In Line Appearance mode, all Desksets that share assigned lines can view held calls and take calls off hold.

To hold calls and manage held calls:

1. When you are on an active call, press **HOLD**.

The Held Call icon  appears and the Line Appearance LED flashes slowly.

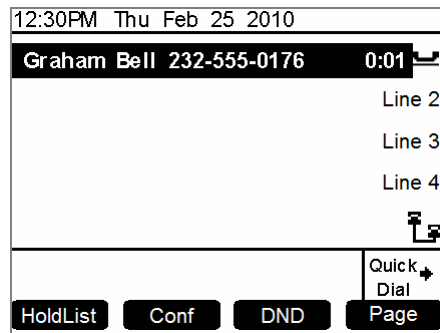

- On other Desksets that are assigned that line, the Line Appearance LED flashes slowly. Someone at any other Deskset assigned that line can press the flashing Line Appearance key to take the call off hold, making it an active call on their Deskset.
 - All Desksets, including those that are not assigned that line, can view and take your call off hold from the Held Calls list. See [“Accessing the Held Calls List” on page 109](#).
 - When you put an Intercom call on hold, only you can take the call off hold.
 - When a call is on hold, you can use the Deskset Menu to access other functions.
 - When a call is on hold, you can also press **Conf** to start a conference call. See [“Making a Conference Call” on page 78](#).
2. To take the call off hold, press the Line Appearance key for that call.



Transferring a Call



This section applies to Call Appearance mode only. To make calls available to other Desksets when your system is in Line Appearance mode, put a call on hold. Someone at another Deskset can retrieve the call if that line has been assigned to their Deskset as described in ["Putting a Call on Hold \(Line Appearance Mode\)" on page 74](#). To view and access held calls on all lines, see ["Accessing the Held Calls List" on page 109](#).

You can transfer an active or a held call to an internal extension or outside number.

The transfer recipient does not have to talk to you before receiving the transferred call. If you do not talk to the transfer recipient before transferring the call, you are making an "unsupervised" transfer. If you talk to the transfer recipient before completing the transfer, you are making a "supervised" transfer.

You can transfer a call to an outside number only if this function has been enabled by your system administrator. The call transfer function is enabled by default.

You can also transfer a call directly to voicemail by selecting an extension, Group Mailbox (if available), or your Personal Mailbox.

To transfer calls with the Cordless Handset, see ["Transferring" on page 85](#).

To transfer a call:

1. Press **Transfer** from the Active Call screen. The call is automatically put on hold and the Transfer Setup screen appears.

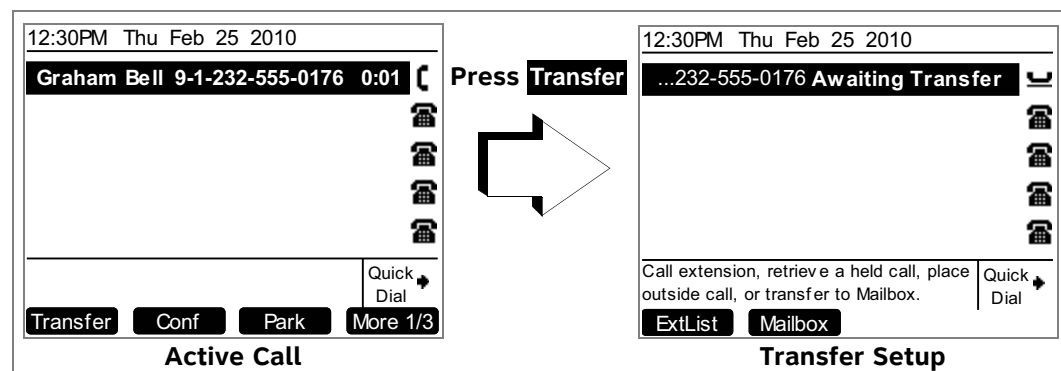

2. Select a transfer target. You can:
 - dial an outside number (as shown below) or an extension, or make a call from a list by pressing **ExtList**, for example. See ["Outgoing Calls" on page 43](#).



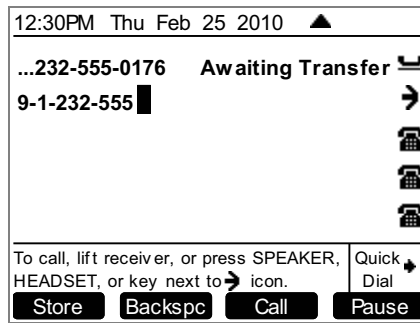

- transfer the call directly to voicemail by pressing **MBList** to select a Personal or Group Mailbox (if available), or by pressing **VMList** to select an extension's Personal Mailbox. Go to Step 4.
3. When the new call is established, you are ready to transfer the first call. You can:
 - speak to the person to whom you are transferring the call and announce the transfer.
 - cancel the Transfer Setup screen on the first call by pressing **CANCEL**. The call remains on hold.
 4. To complete the transfer, press **Xfer?**.

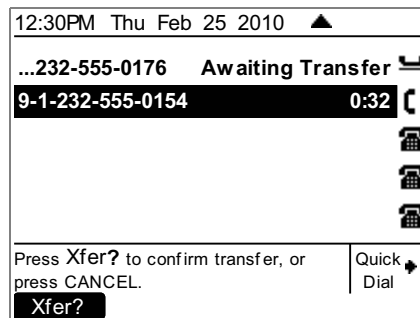

A **Call Transferred** screen appears for two seconds. When the transfer is complete, the screen returns to Idle mode.

To do this with the Cordless Handset, see ["Transferring" on page 85](#).



Transferring a call to a busy extension

If you try to transfer a call to an extension in your office that is on an active call or is paging, the Extension Status screen reads **on a call**, as shown in Figure 31.

If the other extension has Do Not Disturb ON, the Extension Status screen reads **Busy**, as shown in Figure 31.

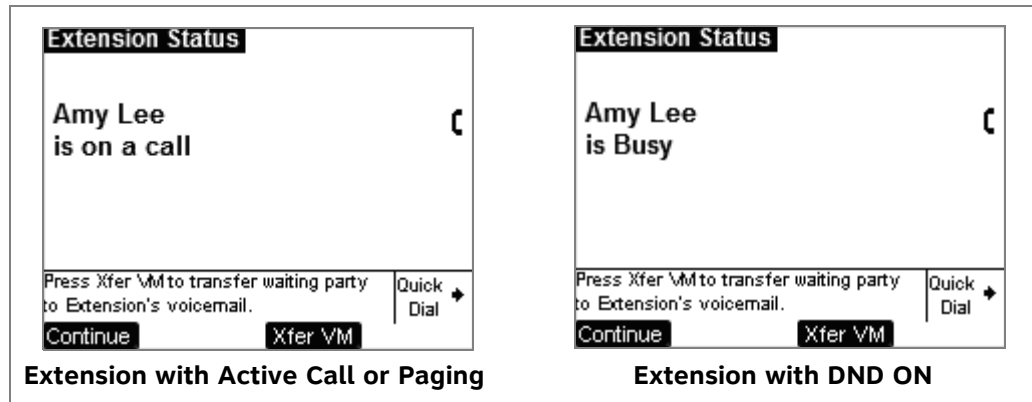

Figure 31. Extension Status Screens

You can press:

- **Continue** to call the other extension. Your incoming call appears on the other Deskset's screen, and the other party can answer your call if they wish.
- **Xfer VM** to transfer the waiting party directly to the other extension's Personal Mailbox.



Making a Conference Call

You can set up a conference call with yourself and two telephone numbers (either internal, outside, or with both). The pictures below show Call Appearance mode, but the procedure is the same in Line Appearance mode.

To make a conference call:

1. Press **Conf** from an Active Call screen. The call is put on hold and the Conference Setup screen appears.

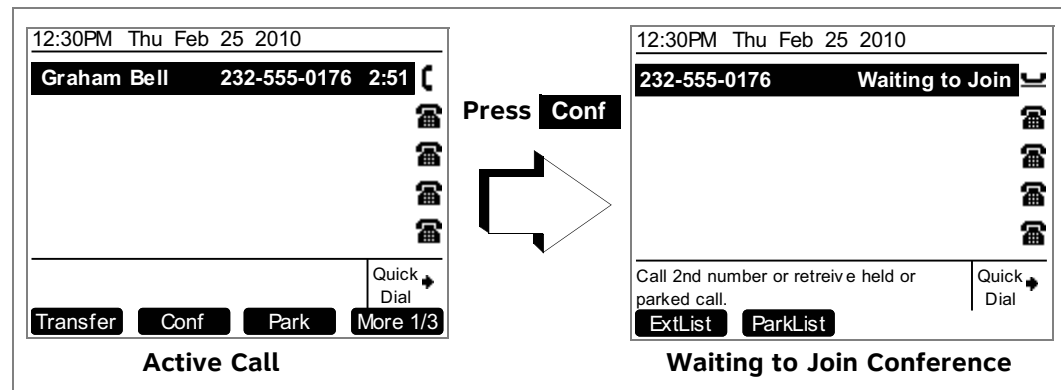

2. Establish a second call. You can dial the second call normally, or you can select a held call and take it off hold, or you can start the second call from a list. See ["Accessing Items in Lists" on page 96](#).

When the second call has been established, the **Join?** soft key appears.

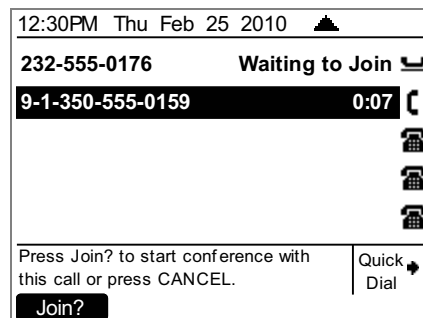

3. To join the calls, press **Join?**.

Your extension is now in conference with the other two phone numbers.



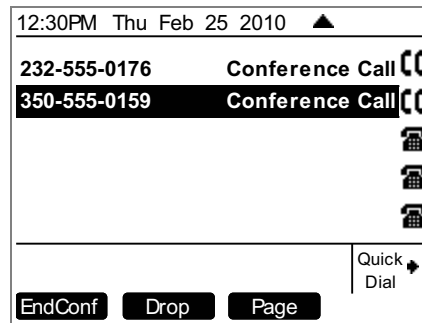

If you hang up while on the conference, the conference ends. If you make or answer another call, the conference continues without you. You can rejoin by pressing a corresponding Call Appearance or Line Appearance key.

To do this with the Cordless Handset, see ["Making a Conference Call" on page 87](#).

Putting a Conference on Hold

The pictures below show Call Appearance mode, but the procedure is the same in Line Appearance mode.

To put a conference on hold:

1. Press **HOLD**.

The other callers can continue communicating with each other. The held conference icon indicates a held conference.

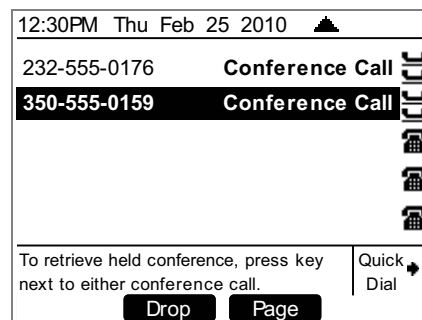

NOTE **Conf** is unavailable during an active call if you have another conference on hold.

A conference is automatically put on hold when you:

- Press an available Call Appearance or Line Appearance key to start a new call.
- Answer an incoming call.

To take a conference call off hold:

1. Press a corresponding Call Appearance or Line Appearance key.



Ending a Conference

To end a conference:

From the Conference screen, you can press:

- **EndConf** to end the conference. Both calls hang up and your Deskset returns to the Idle screen or the Call Appearance or Line Appearance you were on before the conference call.
- **Drop** to end the highlighted call. The other call remains active.

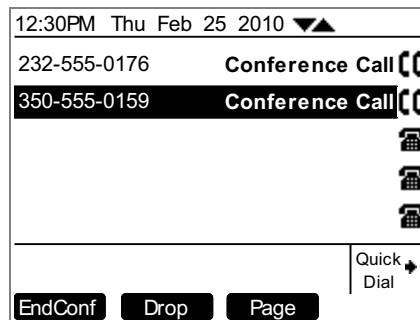

Parking a Call



This feature applies to Call Appearance mode only.

Parking a call is similar to putting a call on Hold, but any extension on the system can retrieve a parked call. You can park outside calls only.

To park a call:

1. Press \triangle or ∇ to highlight the outside call you want to park.
2. Press **Park** . If necessary, press a **More** soft key to display the **Park** soft key.

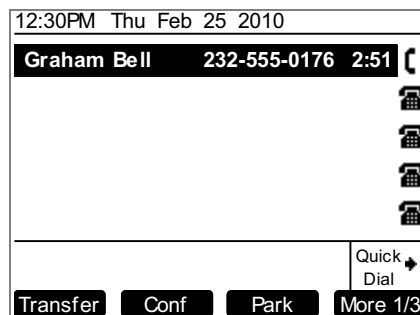

A notification screen appears for five seconds, then the Idle screen appears.

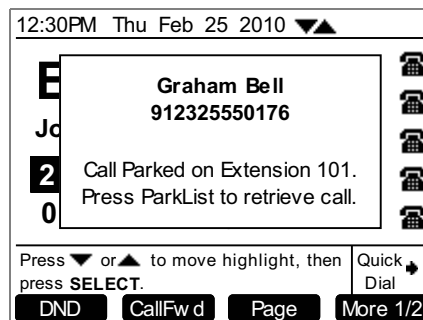

If no one retrieves the parked call within three minutes, your Deskset rings and the parked call appears. To answer the call, press **Answer** .

To do this with the Cordless Handset, see ["Parking a Call" on page 92](#).



Retrieving a Parked Call

You can retrieve parked calls from any extension in the system.

To retrieve a parked call:

If you know the extension number of the parked call, dial it. You will retrieve the parked call.

OR

1. Press the **More** soft key until the **ParkList** soft key appears.
2. Press **ParkList** to display the **Parked Calls** list.

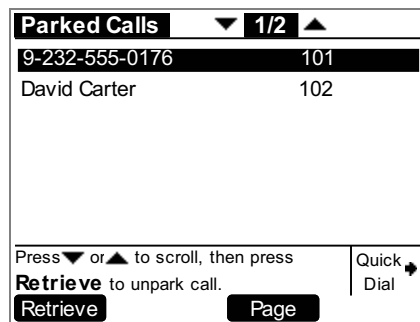

3. Press **△** or **▽** to highlight the desired entry.
4. Press **Retrieve** to retrieve the parked call. The Active Call screen appears.

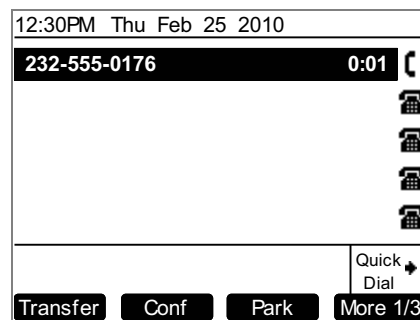

To do this with the Cordless Handset, see ["Parking a Call" on page 92](#).



Call Management Using the Cordless Handset



Cordless Handset operation is compatible with Call Appearance mode only.

You can also manage calls with the optional SB67040 Cordless Handset using the following functions:

- ["Transferring" on page 85](#)
- ["Making a Conference Call" on page 87](#)
- ["Managing Held Calls" on page 90](#)
- ["Held Call Options" on page 91](#)
- ["Parking a Call" on page 92](#)
- ["Using a Corded Headset" on page 94.](#)



Active Call Screens

The Cordless Handset Call Management functions begin with one or more active calls, as shown in Figure 32.

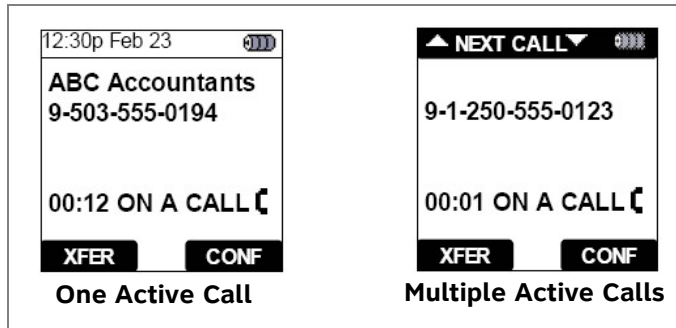

Figure 32. Active Call Screens



Transferring

As with the Deskset, you can transfer an active or held call with the Cordless Handset.

Transferring to an Extension

To transfer an active or held call to an extension:

1. Press **XFER**. The Cordless Handset displays the **Transfer To** screen.

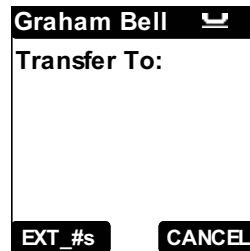

2. Press **EXT_#s** to display the **EXTENSION** list.

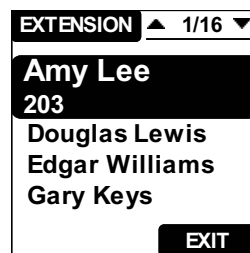

3. Press \triangle or ∇ to view Extension list entries.
4. Press **SELECT**, **SPEAKER**, or **PHONE** to select an Extension number as a transfer destination.
5. Press **XFER** to complete the transfer.



NOTE

You can press **XFER** before the extension picks up (unsupervised transfer) or after the extension picks up (supervised transfer).

The Transfer action can be canceled by pressing **CANCEL**. The call remains on hold.



Transferring to an Outside Number

To transfer an active or held call to an outside number:

1. From either an active or held call, press **XFER**. An active call is put on hold, and the Cordless Handset displays the **Transfer To** screen.

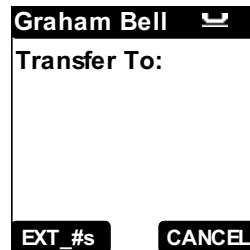

2. To transfer a call to an outside number, dial the number directly or access the outside number through the Call Log, Redial list, Directory, or Quick Dial.



For outside phone numbers in Voicemail and CID lists, Synapse dials whatever digit, if any, that must be dialed first and then dials the number in the display. Therefore, numbers that need editing (adding a preceding 1 or a country code, or removing the area code) cannot be dialed from Voicemail. Press \triangleleft or \triangleright to edit Call Log entries.

3. To dial the selected number as a transfer destination, press **SPEAKER** or **PHONE**. A screen similar to the one shown below appears.



4. Press **XFER** to complete the transfer.



You can press **XFER** before the extension picks up (unsupervised transfer) or after the extension picks up (supervised transfer).



Making a Conference Call

You can set up a conference call with two other numbers (either internal, outside, or with both).

To set up a conference with the Cordless Handset:

1. When you have connected with the first call to be conferenced, press **CONF**. The active call is automatically put on hold and the Start Conference screen appears.

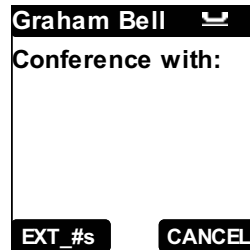

2. Establish a second call. The second call can be dialed normally or from one of the lists. Once the second call has been established, the screen changes to display **JOIN?**.



3. To join the calls, press **JOIN?**.

The selected parties are now in conference.

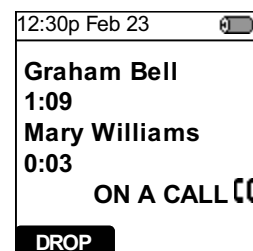

Putting a Conference Call on Hold

To put a conference on hold with the Cordless Handset:

1. Press **HOLD** or **PHONE** to put the conference on hold. An **ON HOLD** screen appears. If you press **PHONE**, you hear a dial tone and are in the Live Dial mode.

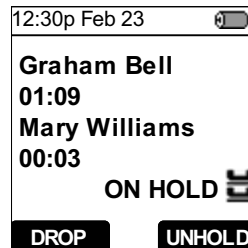

The first and second calls are put on hold but are able to communicate with each other.

2. Press **UNHOLD** to release the call from hold.

Ending a Conference Call

When ending a conference call, you can hang up all the calls together, or hang up one call at a time.

To end a conference call with the Cordless Handset:

1. To hang up all calls, press **OFF**.
OR
 To hang up one call:
 - a. Press **DROP** from the conference screen.

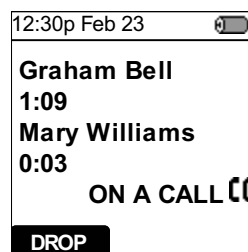

- b. Press \triangle or ∇ to highlight the call you want to hang up.

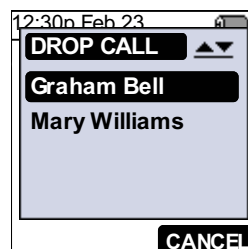

- c. Press **SELECT** to hang up the highlighted call from the conference. You return to an active call mode with the remaining call.

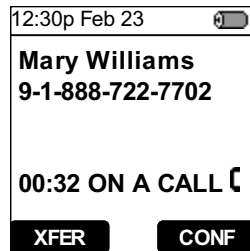

If you have held calls, the Cordless Handset returns to Held Calls mode. If there are no held calls, the Cordless Handset returns to Idle mode.



Managing Held Calls

You can put a maximum of five calls on hold.

To put an active call on hold and to retrieve it:

- Press **HOLD**.

The screen changes from **ON A CALL** to **ON HOLD**.

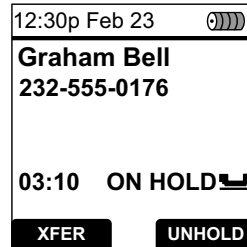

- Press **XFER** to transfer the held call to another number.
- Press **UNHOLD** to retrieve the held call.
- Press **PHONE** to start a new call.
- Press the dial-pad keys to make a new call while on hold. See [“Predialing” on page 53](#).

To retrieve a held call when there is more than one call:

- Press \triangle or ∇ to review calls.



- Press **UNHOLD** when the call you want to retrieve is displayed. You return to the active call.



Pressing **PHONE** or **SPEAKER** does not release the call from hold. Those keys start a new call. Pressing **SELECT** has no effect.



Held Call Options

To view Held Call options:

While viewing a held call screen, press **OPTIONS** to access the Hold options listed below.

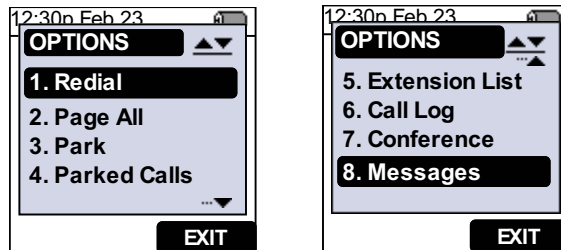

- | | |
|--------------------------|--|
| 1. Redial | Accesses the Redial list. See “Accessing the Redial List with the Cordless Handset” on page 113. |
| 2. Page All | Pages all other extensions. See “Paging with the Cordless Handset” on page 169. |
| 3. Park | Parks the current held call and adds the call to the Parked Calls list. See “Parking an Active or Held Call” on page 92. |
| 4. Parked Calls | Accesses the Parked Calls list. See “Parking a Call” on page 92. |
| 5. Extension List | Accesses the Extension list. See “Accessing an Extension with the Cordless Handset” on page 111. |
| 6. Call Log | Accesses the Call Log. See “Accessing the Call Log with the Cordless Handset” on page 160. |
| 7. Conference | Goes to conference setup and uses the current held call. See “Making a Conference Call” on page 87. |
| 8. Messages | Retrieves Voicemail. See “Retrieving Personal Voicemail with the Cordless Handset” on page 147. |



Parking a Call

Putting a call on hold and parking a call are similar operations. The difference is that a held call can only be retrieved at the Deskset or Cordless Handset that put the call on hold, and a parked call can be retrieved at any extension.

Parking an Active or Held Call

To park a call:

1. Press **OPTIONS** from an active or held call to display the **OPTIONS** screen.
2. Press **3** to park the call.

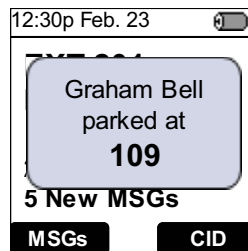

The parked call is given a parked call number and is available at all system extensions.

To page others to let them know about this call, see [“Paging with the Cordless Handset” on page 169](#).



NOTE

When a held call is parked, it is removed from the list of held calls.

Retrieving a Parked Call From Any Extension

To retrieve a parked call:

1. If you know the number of the parked call, press **PHONE** and dial the parked call number.

OR

Access the Parked Calls list. From Idle mode, press **OPTIONS** then **3**.

OR

If you are on a call already, press **OPTIONS** then **4**.

The **Park List** screen appears.

PARK LIST ▲ 1/9 ▼	
9-604-555-0129	101
David Carter	102
Graham Bell	103
1-800-555-0176	104
Robert Brown	105



2. Press \triangle or ∇ to highlight a parked call.
3. Press **SELECT**, **SPEAKER**, or **PHONE** to unpark the selected call and make it an active call.



Using a Corded Headset

You can use a corded headset with the Cordless Handset, as shown in Figure 33.

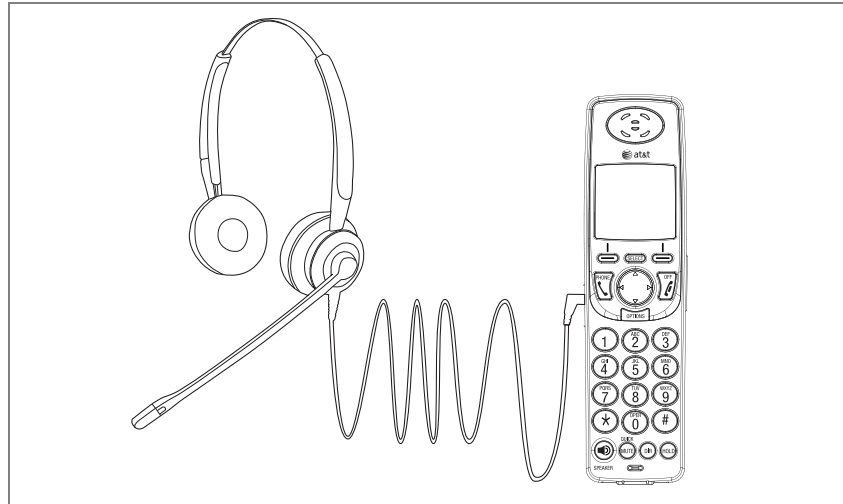

Figure 33. Corded Headset

To use a corded headset with the Cordless Handset:

- Lift the rubber flap covering the 2.5 mm jack on the left side of the Cordless Handset and insert an optional corded headset.
- While a corded headset is connected, the audio that would normally be handled by the Handset is handled by the corded headset.
- The Cordless Handset returns to normal operation when the corded headset is disconnected.

Call Management Using a Headset

You can use a TL7600 Cordless Headset, as shown in Figure 34 or a corded headset with the Deskset.



Figure 34. TL7600 Cordless Headset



NOTE

You can register an optional TL7600 Cordless Headset directly to your Synapse Deskset. There are no wires or cords except for the power cord to the Headset charger. To learn more about the AT&T TL7600 Cordless Headset, visit our web site at www.telephones.att.com/smb or call **1 (888) 916-2007**. In Canada, dial **1 (888) 883-2474**.

To use a Headset:

- From Idle mode or during a call using the corded handset or speakerphone, press **HEADSET**.

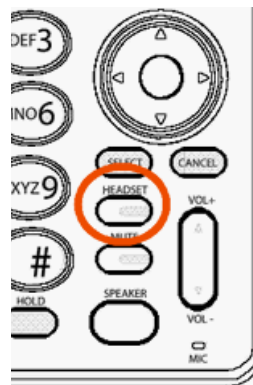

If you have a headset connected to the jack on the back of the Deskset, then that headset becomes active.

If you have a AT&T TL7600 Cordless Headset registered to the Deskset, then the Cordless Headset becomes active.

- To send audio from the headset to the Deskset speakerphone, press **SPEAKER**.
- To send audio from the headset to the corded handset, lift the handset. If the handset is already off hook, press **HEADSET** to send audio to the handset. While the handset is off hook, you can press **HEADSET** again to return audio to the headset.



CHAPTER
5

ACCESSING ITEMS IN LISTS

The Deskset has lists of phone numbers that are used for making calls and for call management. Some of the lists, like Voicemail, are explained elsewhere in this guide. In this chapter, you learn how to access an individual item in a list. All instructions start from the Idle screen.

The Deskset may provide access to the following lists:

- **Call Queue List** — See [“Accessing the Queued Calls List” on page 97](#)
- **Park List** — See [“Accessing the Park List” on page 98](#)
- **Voicemail List** — See Chapter 7, [“Voicemail” on page 126](#)
- **Directory List** — See Chapter 6, [“Directory” on page 115](#)
- **Call Log** — See Chapter 8, [“Call Log” on page 151](#)
- **Extension List** — See [“Accessing the Extension List” on page 102](#)
- **Quick Dial** — See [“Accessing the Quick-Dial List” on page 103](#)
- **Redial List** — See [“Accessing the Redial List” on page 106](#)
- **Held Calls List** — See [“Accessing the Held Calls List” on page 109](#).

You can also access some of these lists with an optional Cordless Handset. See [“Accessing and Managing Items in Lists with the Cordless Handset” on page 110](#).



Accessing the Queued Calls List



This feature applies to Call Appearance mode only.

NOTE

The system administrator can configure the system to forward Incoming Calls to the Call Queue. The **Queued Calls** list contains unanswered calls. If the system administrator has assigned your extension to the Call Queue, queued calls ring at your extension when your extension becomes idle. You can also view and answer queued calls by accessing the **Queued Calls** list.

Your system administrator may have set up your Deskset screen to show the **Call Queue** key in the bottom right corner. The Call Queue key LED flashes orange slowly when there are calls waiting in the Call Queue, as shown in Figure 35.

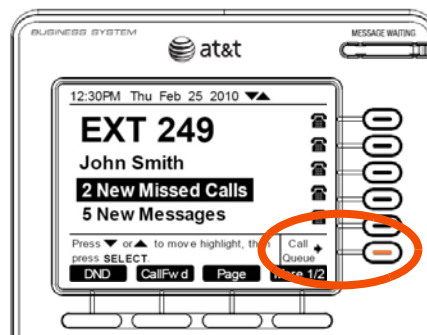

Figure 35. Call Queue Key

To access the Queued Calls list:

1. Press the **Call Queue** key. The **Queued Calls** list appears.

Queued Calls			▼ 1/10 ▲
Graham Bell	232-555-0176	3:01	
Charlie Johnson	212-555-0154	2:58	
Mary Williams	706-555-0162	2:47	
Linda Miller	317-555-0129	2:32	
ABC Accountants	305-555-0134	1:44	
Unknown Caller	443-555-0625	1:24	
Milford Taxi	732-555-7318	0:35	
Use ▼ or ▲ to scroll, then press Retrieve to answer the call.			Call Queue →
Retrieve			

The oldest queued call is at the top of the list.

2. Press ▼ or ▲ to highlight the desired entry.
3. Press **Retrieve** or **SELECT** to answer the queued call.

You can press **CANCEL** at any time to exit the **Queued Calls** list.



Accessing the Park List



This feature applies to Call Appearance mode only.

NOTE

Use the **Parked Calls** screen to access parked calls from any extension. See ["Parking a Call" on page 81](#).

To access an entry in the Park List:

1. Press **More** until the **ParkList** soft key appears.
2. Press **ParkList**. The **Parked Calls** list appears.

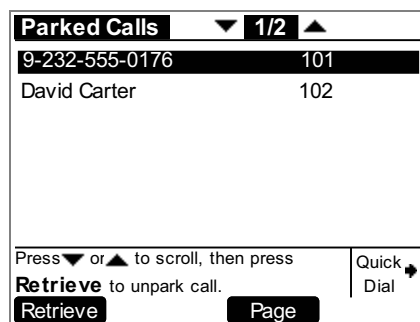

3. Press **△** or **▽** to highlight the desired entry.
4. Press **Retrieve** to retrieve the parked call. The Active Call screen appears.

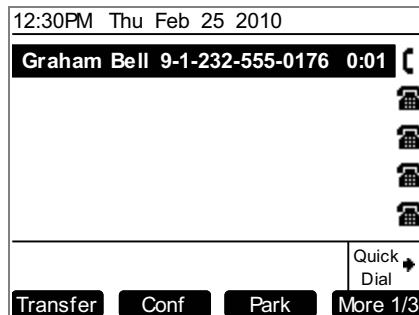

Accessing Voicemail

For more information about Voicemail, see ["Voicemail" on page 126](#).

To access an entry from Voicemail:

1. From the Idle screen, press **MESSAGES**.

If necessary, use the dial pad to enter your user password and press **SELECT**.



Once you have entered your password, you do not have to enter it again while you are reviewing messages. However, if you exit the **Messages** screen or go to another feature, you will need to enter your password to access the Message list.

The screen that appears depends on your system configuration.

If you do not have Voicemail Distribution enabled or access to a Group Mailbox, the **Messages** list appears.

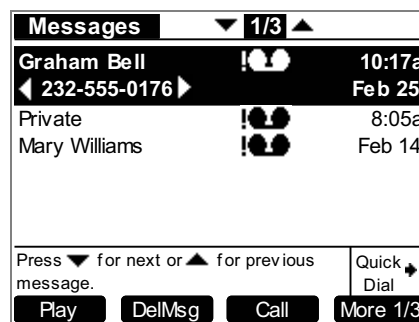

If you have enabled Voicemail Distribution (see ["Voicemail Distribution" on page 211](#)), the **Leave New Message or Listen** screen appears.

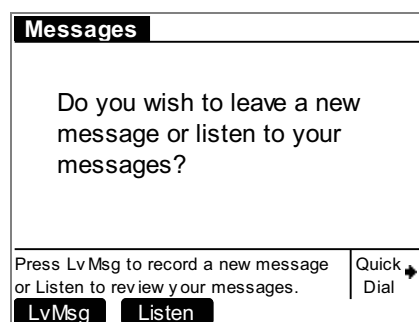

- Press **Lv Msg** to create a message to send to a Voicemail Distribution List. See ["Sending a New Message to a Distribution List" on page 138](#).
- Press **Listen** to view the Mailbox List (if you have Group Mailboxes), or the **Messages** list.



If your system administrator has assigned a Group Mailbox to you, a list of your Personal Mailbox and Group Mailboxes appears.

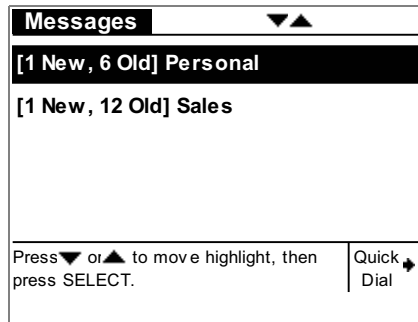

- a. If necessary, press ▼ or ▲ to highlight the desired Mailbox.
- b. Press **SELECT**. The **Messages** list appears.
2. Press ▼ or ▲ until you highlight the desired **Messages** entry.
See ["Voicemail" on page 126](#) for more information about Group Mailboxes.
3. Press **CANCEL** to exit the Voicemail list.

To view your Voicemail with the Cordless Handset, see ["Accessing Personal Voicemail with the Cordless Handset" on page 145](#). Voicemail Distribution and Group Mailboxes are not supported on the Cordless Handset.



About the Extension List

You can access the Extension list illustrated in Figure 36 from Idle, Live Dialing, Transfer, and Conference Setup modes.

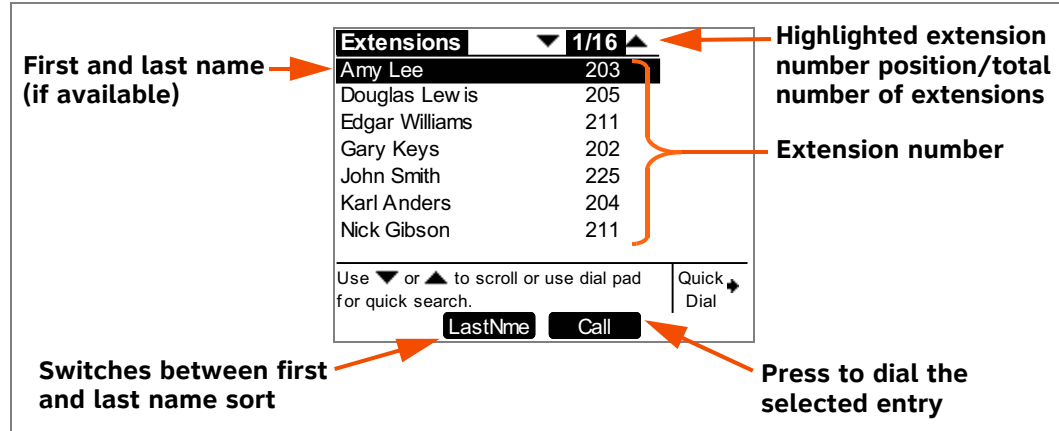

Figure 36. Extension List Functions



Accessing the Extension List

You can access the Extension List as part of the Directory when the phone is idle. See ["Using the Directory" on page 65](#). When you go off-hook, you can access the Extension List using the **ExtList** soft key that appears.

To access the Extension List:

1. **Call Appearance mode:** From the Idle screen, press **More 1/2** and then press **ExtList**.

Line Appearance mode: From the Idle screen, press **ExtList**.

OR

When dialing live (off hook), press **ExtList**.

The **Extensions** list appears.

Extensions	1/16
Amy Lee	203
Douglas Lewis	205
Edgar Williams	211
Gary Keys	202
John Smith	225
Karl Anders	204
Nick Gibson	211

Use ▼ or ▲ to scroll or use dial pad for quick search. Quick Dial

LastName Call

2. Press ▼ or ▲ until you highlight the desired entry.

OR

Use the dial pad to jump to the first name that begins with the first letter of the key that you press.

3. Press **Call** to call the highlighted extension.



NOTE

You can also access the Extension list from the following:

- **Transfer** — Call Appearance mode only. See ["Transferring a Call" on page 75](#).
- **Conference Setup** — See ["Making a Conference Call" on page 78](#).

To do this with the Cordless Handset, see ["About the Cordless Handset Extension List" on page 111](#).



Accessing the Quick-Dial List

The Quick-Dial list provides up to six entries for frequently called numbers and is available in Call Appearance mode and Line Appearance mode.

To access and dial Quick-Dial numbers:

1. Press the button to the right of .

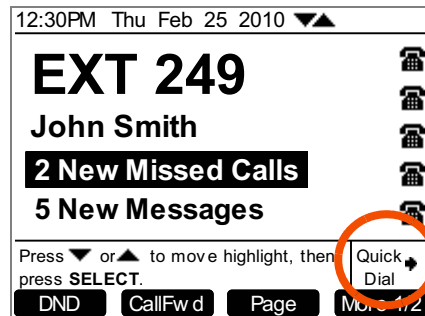

Quick-Dial labels appear.

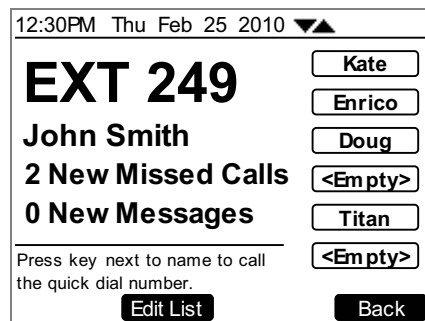

2. Press a Quick-Dial button to the right of a label to dial that number.

To do this with the Cordless Handset, see ["Accessing the Quick-Dial List with the Cordless Handset" on page 112](#).

Editing Quick Dial Entries

After you access a Quick-Dial entry, you can add and edit Quick-Dial entries using the Deskset or the WebUI. To edit entries using the WebUI, see ["Quick-Dial Keys" on page 210](#).

To edit Quick Dial from the Deskset:

1. Press the key to the right of  to display the Quick-Dial list.
2. Press **Edit List** to add or edit a Quick-Dial entry. The Quick-Dial edit screen appears.



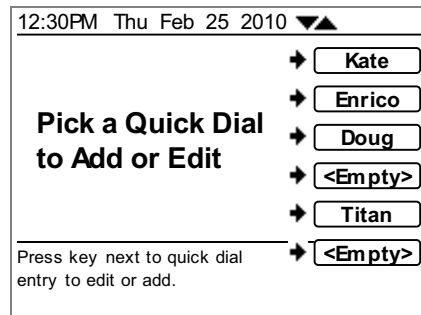

3. Press the key to the right of the entry you want to edit.
4. Enter the desired name and number. Press **Backspc** to erase the highlighted character if there is one, or else the character before the cursor.

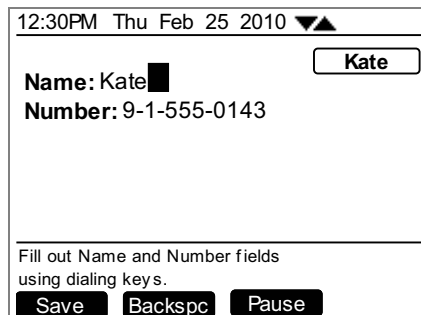

- a. Enter the name.
- b. Press ∇ and enter the number.
Enter the digit **9** or whatever digit, if any, that must be dialed for outside calls before the phone number to dial an outside number. To include a pause in the number, press **Pause**.
5. Press **Save** to store the number. The Quick-Dial list appears.



About the Redial List

The last 20 phone numbers that you dialed are recorded in the Redial list, as shown in Figure 37.

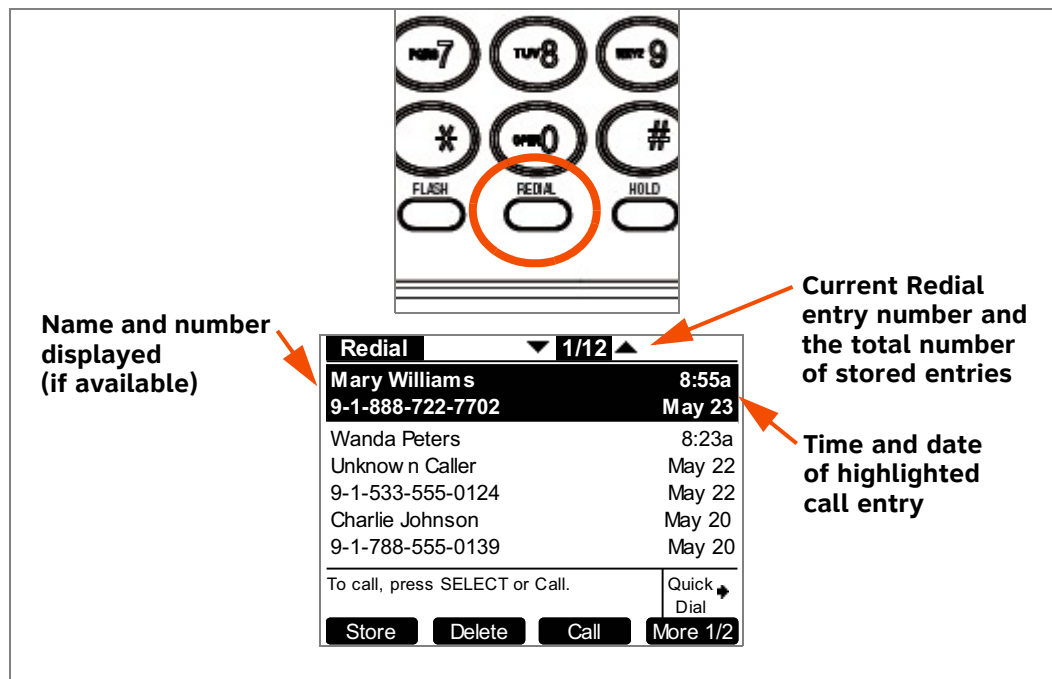

Figure 37. Redial List

Table 19. Redial List Function

Key	Description	Key	Description
Store	Stores number in Personal list.	Delete	Deletes an entry.
Details	Shows more details for a particular entry.	DelAll	Deletes all entries.
Call	Dials the selected entry.	More	Moves to the next set of soft keys. If this key appears, there are more than four soft keys available. More 1/2 indicates that you are on page one of two.



Accessing the Redial List

To access a Redial entry:

1. Press **REDIAL** to display the Redial List, as shown in Figure 37.
2. Press ∇ or \triangle until you highlight the desired entry.
3. Press:
 - **Call** to redial the number.
 - **More 1/2**, then **Details** to display details about the highlighted entry.

- **Store** to store the caller's number. The **Personal Entry** screen appears with the First Name and number filled in.

- If necessary, edit the name and number. Press ∇ to move the cursor to the **Last Name** and **Phone #** entries.
- Press **Save** to save the entry.



NOTE The system does not check for duplicate entries.

4. Press **CANCEL** to exit the Redial list.

To do this with the Cordless Handset, see ["Accessing the Redial List with the Cordless Handset" on page 113](#).



Deleting Redial Entries

You can delete a single Redial entry from the Redial list or all Redial entries. Ensure the entry you wish to delete is highlighted.

To delete a single entry:

1. Press **REDIAL** to access the Redial list.
2. Press ∇ or \triangle until you highlight the desired entry.
3. Press **Delete**.
4. Press **CANCEL** to exit the Redial list.

To do this with the Cordless Handset, see ["To delete entries from the Redial list:" on page 113.](#)

To delete all Redial entries:

1. Press **REDIAL** to access the Redial list.
2. Press **More 1/2** to display the **DelAll** soft key.
3. Press **DelAll**. A Confirmation screen appears.

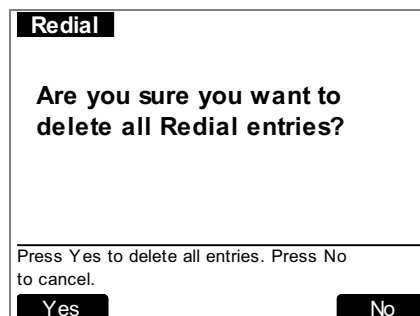

4. Press **Yes** to confirm deletion.
5. Press **CANCEL** to exit the Redial list.



Searching the Directory or Extension Lists Using the Dial Pad

Use the dial pad to view the first entry that starts with any letter.

To search for a list entry on the Deskset:

1. Select a list to search, such as the Directory.

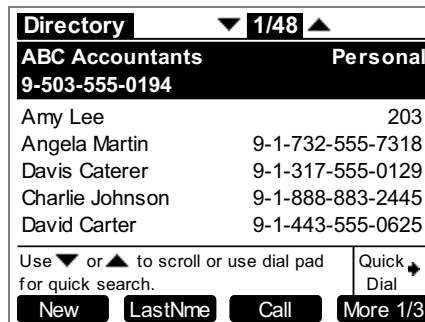

2. Press the dial-pad keys to cause the Deskset to search for an exact match or the closest match. For example:

- If you press **4** once, the Deskset searches for names beginning with **G**.
- If you press **4** twice, the Deskset searches for names beginning with **H**.

See [“Deskset Dial-Pad Entry” on page 23](#) for information on entering other individual letters. This searching function uses only the uppercase letters.

When an exact match is found, the entry is highlighted.

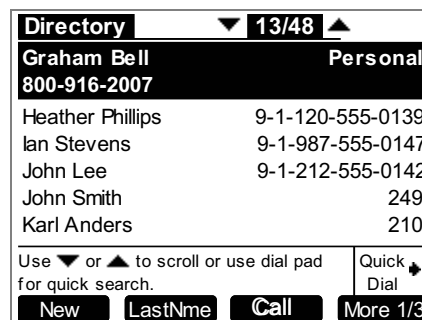

If you enter a letter and the Deskset cannot find an exact match, the entry with the next closest alphabetical match is highlighted.



Accessing the Held Calls List



This feature applies to Line Appearance mode only.

NOTE

When you or anyone else in your office puts an external call on hold, the call is displayed in the Held Calls List. From the Held Calls List, you can view and retrieve any held call in the system.

Your Deskset Line Appearance LEDs also show which lines have held calls on them, but only for the lines assigned to that Deskset. All Desksets in the system may not have the same lines assigned to them. For example, your department may have lines 1 to 4 assigned to your Desksets. Another department in your company may have lines 5 to 8 assigned to their Desksets. Using the Held Calls List at your Deskset, you can access calls being held on lines 1 to 8.

To view and retrieve calls from the Held Calls List:

1. Press **HoldList**.

The **Calls on Hold** screen appears.

Calls on Hold ▼ 1/4 ▲		
Graham Bell	Line 3	3:32
	Line 1	2:10
Amy Lee	Line 8	1:46
1-800-123-1234	Line 2	0:12
Press ▼ or ▲ to scroll, then press		
Retrieve to un-hold call.		
Retrieve	Page	Quick Dial →

2. Press ▼ or ▲ to highlight the desired call.
3. Press **SELECT** to retrieve the call.

The call becomes active on your Intercom line. Any previous active call on your Deskset goes on hold.



NOTE

If you put a Line Appearance call on hold then retrieve the same call from the Held Calls List, you will only be able manage the call on the Intercom line.



Accessing and Managing Items in Lists with the Cordless Handset

You can also access the phone number lists with the optional SB67040 Cordless Handset.



NOTE

Cordless Handset operation is compatible with Call Appearance mode only.

All instructions start from the Idle screen.

The Cordless Handset provides access to the following lists:

- **Extension List** — See [“About the Cordless Handset Extension List” on page 111](#)
- **Quick-Dial List** — See [“Accessing the Quick-Dial List with the Cordless Handset” on page 112](#)
- **Redial List** — See [“Accessing the Redial List with the Cordless Handset” on page 113](#)
- **Directory List** — See [“Accessing the Directory with the Cordless Handset” on page 124](#)
- **Voicemail List** — See [“Accessing Personal Voicemail with the Cordless Handset” on page 145](#)
- **Call Log** — See [“Using the Call Log with the Cordless Handset” on page 161.](#)



About the Cordless Handset Extension List

You can access the Extension list illustrated in Figure 38 from Idle, Live Dialing, Transfer, and Conference Setup modes.

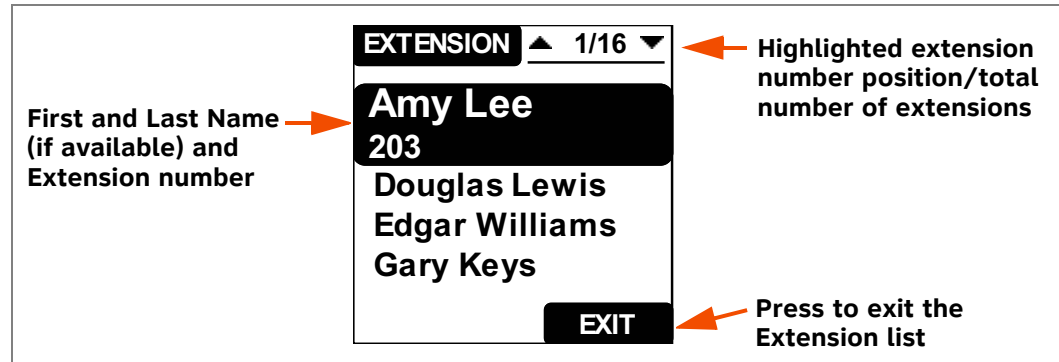

Figure 38. Extension List Functions

Accessing an Extension with the Cordless Handset

The following steps display the **EXTENSION** screen shown in Figure 38.

To access an extension:

1. From the Idle screen, press **OPTIONS** and then press **4**.



NOTE

You can also access the **EXTENSION** screen from the following:

- **Transfer** — See *"Transferring" on page 85*.
- **Conference Setup** — See *"Making a Conference Call" on page 87*.

2. Press ∇ or \triangle until you highlight the desired entry.
You can use the dial pad for a quick search when viewing the Extension list.
3. Press **SELECT** or **PHONE** to dial the highlighted number. If you are accessing the Extension list from Idle mode, pressing **SPEAKER** also dials the selected number.
4. Press **EXIT** to return to the previous screen.



Accessing the Quick-Dial List with the Cordless Handset

The Quick-Dial list provides up to six entries for frequently called numbers. The Quick-Dial entries are not associated with the Directory.

To access and dial Quick-Dial entries:

1. Press and hold **MUTE/QUICK** for at least two seconds.



The Quick-Dial entries appear.

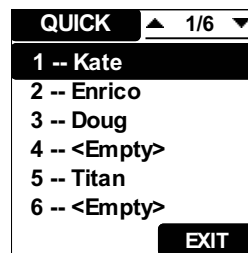

2. Press ∇ or \triangle to highlight the entry to call.

OR

To dial a number immediately, press the number next to the name.

3. Press **SELECT**, **PHONE**, or **SPEAKER** to dial the selected entry.

The screen displays the number, you hear a dial tone, and the number is automatically dialed.

4. If you choose not to dial a number, press **EXIT** to return to the previous mode.



Accessing the Redial List with the Cordless Handset

The last 20 phone numbers that you dialed are recorded in the Redial list.

To access and dial a Redial entry:

1. From the Idle screen, press **OPTIONS**. The menu appears.

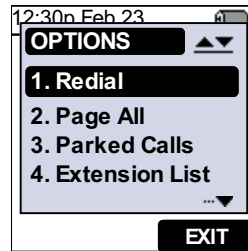

NOTE

Similar menus appear when you press **OPTIONS** during an active or held call.

2. Press **1** to display the **REDIAL** screen.

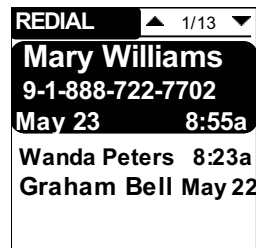

- Press ∇ or \triangle to view Redial entries.
 - Press **SELECT** or **PHONE** to dial out the highlighted number in the Redial list. If you are accessing the Redial list from Idle mode, pressing **SPEAKER** also dials the selected number.
3. Press **EXIT** to return to the previous mode.

To delete entries from the Redial list:

1. From the Idle screen, press **OPTIONS**.
2. Press **1** to display the **REDIAL** screen.

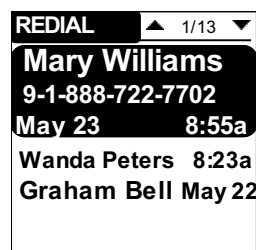

3. Press ∇ or \triangle to view Redial entries.
4. Press **DELETE** to delete the selected entry.

OR

To delete all entries, press **OPTIONS**. The Redial Options menu appears.

- Press **1** or **SELECT** to display the Delete All Confirmation screen.

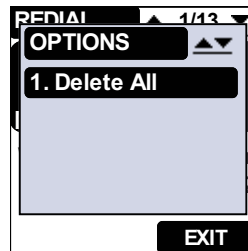

- Press **YES** to delete all Redial entries.
 - Press **NO** to return to the **REDIAL** screen.
5. Press **EXIT** to return to the previous mode.

Searching the Directory or Extension Lists Using the Dial Pad

Use the dial pad to get to the first entry that starts with any letter.

To search for a list entry on the optional Cordless Handset:

1. Select a list to search, such as the Directory.
2. Pressing a dial-pad key causes a letter to display in the center of the Handset screen. The Handset searches for an exact match or the closest match. For example:
 - If you press **4** once, the Handset searches for names beginning with **G**.
 - If you press **4** twice, the Handset searches for names beginning with **H**. See ["Dial-Pad Entry" on page 39](#) for information on entering other individual letters.

When an exact match is found, the highlight moves to that entry.



If you enter a letter and the Handset cannot find an exact match, the highlight moves to the entry with the next closest alphabetical match.



CHAPTER
6

DIRECTORY

The Synapse system provides three Directory lists. By default, the system displays entries from all three lists when you press **DIRECTORY** (or you press **DIR** on the optional SB67040 Cordless Handset). See [“Viewing Directory Entries” on page 117](#) to learn how you can limit this display to one of the three lists.

- **Personal** — You can add, edit, and delete up to 50 entries in this Personal directory from the Deskset or the WebUI (referred to as “Extension Directory” on the WebUI). These entries are available only at your extension.
- **System** — This public directory is created and maintained by the system administrator. You can view and sort this directory, but you cannot modify it.
- **Extension** — This is a list of all extensions in the system. It contains the Display Names that the administrator entered and the extension number of each Deskset. You can view and sort this directory, but you cannot modify it.
 - [“Using the Directory” on page 116](#)
 - [“Viewing Directory Entries” on page 117](#)
 - [“Creating a New Personal List Entry” on page 119](#)
 - [“Editing a Personal List Entry” on page 120](#)
 - [“Storing Directory Entries from the Call Log or Redial List” on page 121](#)
 - [“Sorting Directory Entries” on page 123](#)
 - [“Accessing the Directory with the Cordless Handset” on page 124.](#)



Using the Directory

Access the Directory by pressing **DIRECTORY** to display the screen shown in Figure 39.

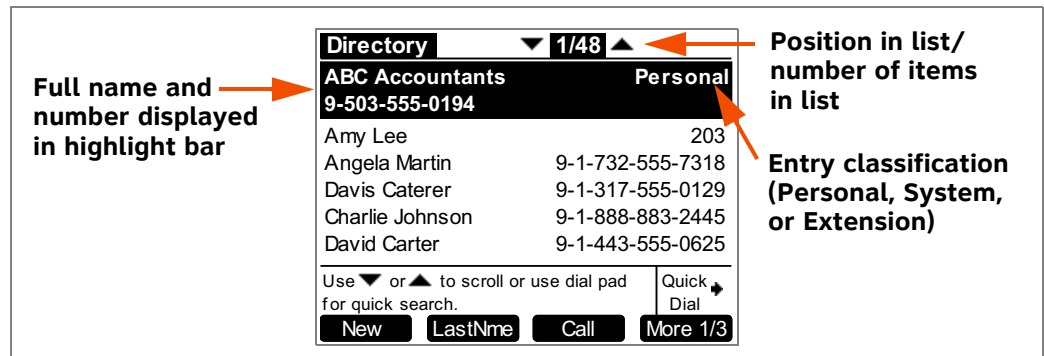

Figure 39. Directory Screen Description

Table 20. Directory Screen Description

Key	Description	Key	Description
New	Creates a new entry in the Personal list.	FirstNme	Switches between first and last name sort in Directory and Extension list.
Edit	Allows you to change previously entered information.	LastNme	Switches between first and last name sort in Directory and Extension list.
Details	Displays entry details.	Delete	Deletes the highlighted entry.
Call	Dials the selected entry.	More	Moves to the next set of soft keys. If this key appears, there are more than eight soft keys available. More 1/3 indicates that you are on page one of three.
List	Opens the Directory List Options menu.		



Viewing Directory Entries

You can view all **Directory** entries in one list, or you can view only the Personal list, System list, or Extension list. Within a list, you can press a dial-pad key to see the first name that starts with the first letter on that key. If there is no match, the set displays the next entry in the alphabetical list.

To view and call Directory entries:

1. Press **DIRECTORY**. The Directory list appears.

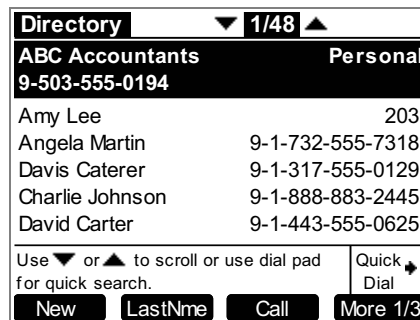

2. Press ▼ or ▲ to highlight the desired entry.
3. If necessary, press **More 1/3** until **Details** appears, then press **Details** to see names and numbers that are too long to be displayed on the **Directory** screen.

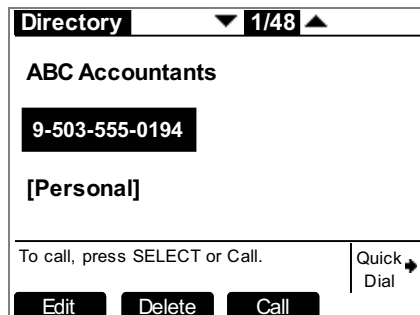

4. Press **Call** to dial the displayed phone number.



To change Directory settings:

1. From the Directory list, press **More 1/3** to display the second set of **Directory** soft keys.

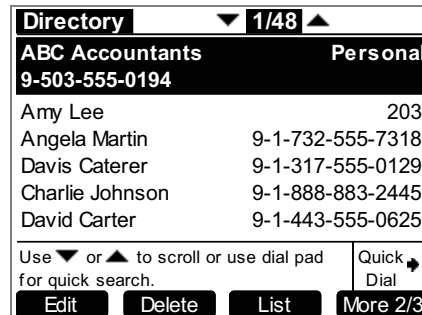

If the Directory is empty, **Edit** and **Delete** do not appear.

2. Press **List**. The **Directory List** appears.

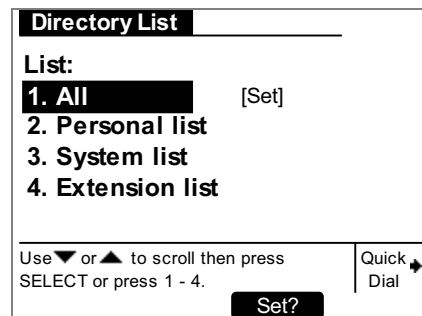

3. Press ∇ or \triangle to highlight the desired list, and press **SELECT**.
The selected list appears.
4. Press **List** to display the **Directory List** screen again.
5. To change the default list, press \triangle or ∇ to highlight the desired list, then press **Set?**.
6. Press **CANCEL** to return to the **Directory**.



Creating a New Personal List Entry

You can add up to 50 personal entries to the **Directory**. These personal entries are only visible at your extension.

To create a new Personal list entry:

1. Press **DIRECTORY** to display the **Directory**.

Directory		▼ 1/48 ▲
ABC Accountants		Personal
9-503-555-0194		
Amy Lee		203
Angela Martin	9-1-732-555-7318	
Davis Caterer	9-1-317-555-0129	
Charlie Johnson	9-1-888-883-2445	
David Carter	9-1-443-555-0625	
Use ▼ or ▲ to scroll or use dial pad for quick search.		Quick Dial
New	LastNme	Call
More 1/3		

2. Press **New** to display the **Personal Entry** screen with the cursor positioned in the **First Name** field.
3. Edit the **First Name**, **Last Name**, and **Phone #** fields using the dial pad. See ["Deskset Dial-Pad Entry" on page 23](#). The name text fields are limited to 20 characters each and the number field is limited to 32 digits.
4. When editing the entry, you have the following options:
 - Press **Left Arrow** or **Right Arrow** to move the cursor.
 - Press **Up Arrow** or **Down Arrow** to move to the previous or next field.
 - Press **Backspc** to erase the highlighted character if there is one, or else the character before the cursor.
 - Press **Pause** to insert a two-second pause into the phone number. The pause appears as a **P** in the field and is counted as a digit.
 - For outside phone numbers, enter a **9**, or whatever digit, if any, that must be dialed first to indicate this is an outside call.
5. Press **Save**. The **Directory** appears.



Editing a Personal List Entry

You can edit any Personal list entry while viewing the **Directory**.

To edit a Personal list entry:

1. Press **DIRECTORY** to display the **Directory**.
2. Press ∇ or \triangle to highlight a **Personal** entry.
3. Press **More 1/3** and **Edit**. The **Personal Entry** edit screen appears.



The **Edit** key is not available when a **System** or **Extension** entry is highlighted in the Directory list.

4. Edit the **First Name**, **Last Name**, and **Phone #** fields using the dial pad. See [“Deskset Dial-Pad Entry” on page 23](#). The name text fields are limited to 20 characters each and the number field is limited to 32 digits.
5. When editing the entry, you have the following options:
 - Press \triangleleft or \triangleright to move the cursor.
 - Press \triangle or ∇ to move to the previous or next field.
 - Press **Backspc** to erase the highlighted character if there is one, or else the character before the cursor.
 - Press **Pause** to insert a two-second pause into the phone number. The pause appears as a **P** in the field and is counted as a digit.
 - For outside phone numbers, enter a **9**, or whatever digit, if any, that must be dialed first to indicate this is an outside call.
6. Press **Save**. The **Directory** appears.



Storing Directory Entries from the Call Log or Redial List

To store a Call Log or Redial entry into your Personal list:

1. Press **CALL LOG** or **REDIAL** to access either list.
2. Press \triangle or ∇ until you highlight the desired entry.
3. Press **Store** to store the entry in your Personal list. (Press **More 1/3** to display **Store** on the **Call Log** screen.) The **Personal Entry** screen appears.

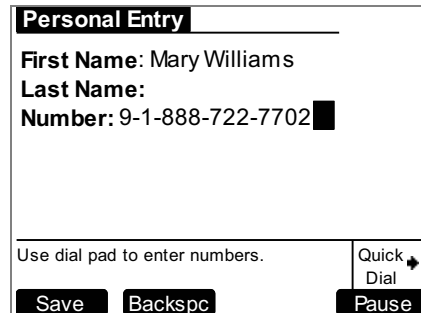

The screenshot shows a screen titled "Personal Entry". It contains three text fields: "First Name: Mary Williams", "Last Name:", and "Number: 9-1-888-722-7702". Below the fields is a "Quick Dial" button with a right-pointing arrow. At the bottom of the screen are three buttons: "Save", "Backspc", and "Pause". A small instruction "Use dial pad to enter numbers." is located above the "Quick Dial" button.

The Deskset automatically fills in the name and number, if available.

- If necessary, edit the name and number. Press ∇ to move the cursor to the **Last Name:** and **Number:** entries.
 - Press **Backspc** to erase the highlighted character if there is one, or else the character before the cursor.
 - Press **Pause** to insert a two-second pause into the phone number. The pause appears as a **P** in the field and is counted as a digit.
 - For outside phone numbers, enter a **9**, or whatever digit, if any, that must be dialed first to indicate this is an outside call.
4. Press **Save** to save the entry.



NOTE

The system does not check for duplicate entries.



Deleting a Personal List Entry

You can delete any one of your personal list entries while viewing the **Directory**.

To delete a Personal list entry:

1. Press **DIRECTORY** to display the **Directory**.
2. Press ∇ or \triangle to highlight the entry to be deleted.
3. Press **More 1/3** to display the **Delete** soft key.
4. Press **Delete**. The confirmation screen appears.

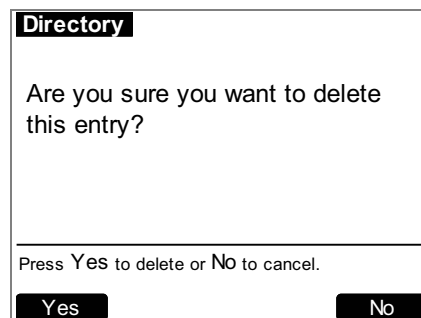

5. To confirm the deletion, press **Yes**.



The **Delete** key is not available when a System or Extension entry is highlighted in the Directory.



Sorting Directory Entries

The **Directory** entries are sorted by first or last names. When you use the dial pad to search, the system searches for the names in the sort order.

To sort Directory entries:

1. Press **DIRECTORY** to display the **Directory**.
2. To sort the entries by last name, press **LastNme** .
To sort the entries by first name, press **FirstNme** .

The **Directory** stays in the chosen sort order until you change it.



Accessing the Directory with the Cordless Handset

You can also access the Directory with the optional SB67040 Cordless Handset.



Cordless Handset operation is compatible with Call Appearance mode only.

All instructions in this section start from the Idle screen.

To access a Directory entry:

1. Press **DIR**. The Directory screen appears.

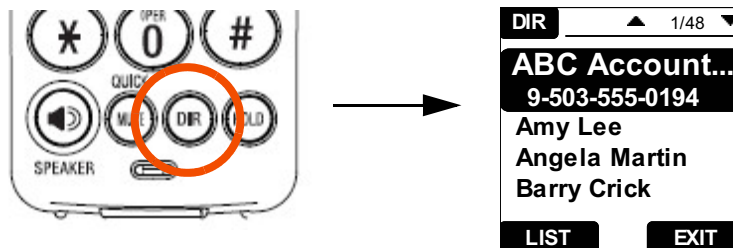

2. Press ∇ or \triangle to scroll to the desired entry.

OR

Press a dial-pad key, as shown in [“Dial-Pad Entry” on page 39](#), to reach the first name in the Directory whose first letter matches or is next in the Directory after that letter. Then press ∇ or \triangle to scroll to the desired entry.

3. Press **SELECT** or **PHONE** to dial the highlighted Directory entry. If you are accessing the Directory from Idle mode, pressing **SPEAKER** also dials the selected number.
4. Press **EXIT** to return to the previous screen.

To select the Directory list you see:

The Cordless Handset displays **All** lists (the combination of your Personal list, the System list, and the Extension list) when you press **DIR**. However, you can temporarily view and select from a specific list.

1. Press **DIR** to access the Directory.
2. Press **LIST**. The **Options** menu appears.

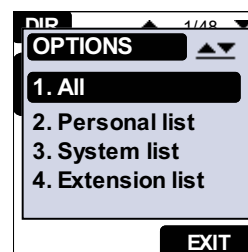

3. Press **1** through **4** to select the desired list.

OR

Press ∇ or \triangle to highlight the desired list, then press **SELECT**.



NOTE

You cannot sort the Directory from the Cordless Handset. The Cordless Handset uses whatever sort order is set on the Deskset. See ["Sorting Directory Entries" on page 123](#).

4. Press **EXIT** to return to the previous screen.



CHAPTER
7

VOICEMAIL

Your Synapse system records and saves incoming Voicemail messages. You can play, delete, or forward those messages to one or many other extensions. The MESSAGE WAITING LED, shown in [Figure 40 on page 127](#), lights up when there is at least one new message.

Each message can be up to 2 minutes long. The Personal Mailbox at your Deskset has 30 minutes of recording time.

Your system administrator may give you access to one or more Group Mailboxes. Group Mailboxes allow more than one person access to Voicemail messages.

You can also record a message and send it to a Voicemail distribution group that you have created. See ["Voicemail Distribution" on page 211](#).

The following sections describe how to listen to and manage voicemail on your Deskset:

- ["Voicemail Overview" on page 127](#)
- ["Accessing Your Messages" on page 131](#)
- ["Sending a New Message to a Distribution List" on page 138](#)
- ["Accessing Your Voicemail Remotely" on page 142](#)
- ["Accessing Personal Voicemail with the Cordless Handset" on page 145](#).



Voicemail Overview

When there is at least one new message, the MESSAGE WAITING LED lights up, as shown in Figure 40.



Figure 40. Message Waiting LED

To access your messages, see [“Accessing Your Messages” on page 131](#). Messages appear in a list as shown in Figure 41. Pressing \triangle or ∇ highlights messages in the list. Pressing \triangleleft or \triangleright displays options for dialing the number.

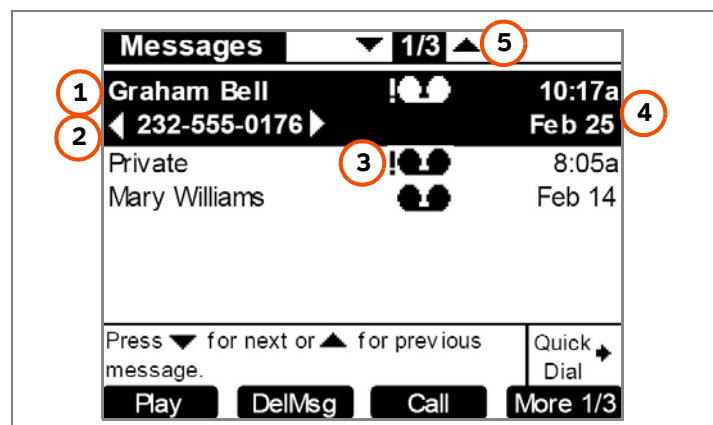

Figure 41. Messages List

1. Name and number displayed

2. Arrows

Indicate dialing options available.

3. Exclamation mark (!)

Indicates a new message.

4. Time and date when message was recorded

Both are shown for highlighted messages. Only the time appears for unhighlighted messages received on the day they are viewed, and only the date appears for unhighlighted older messages.

5. Message Counter

Moves the cursor up/down/left/right on the display.



Table 21. Messages List Soft Key Description

Key	Description	Key	Description
Play	Plays message.	DelMsg	Deletes highlighted Voicemail message from Message list.
FwdMsg	Initiates Message Forward function.	DelAll	Deletes all messages.
MrkNew	Marks an old message as new.	ClerNew	Marks all messages as old.
Call	Dials the selected entry.	More	Moves to the next set of soft keys. If this key appears, there are more than eight soft keys available. More 1/3 indicates that you are on page one of three.
PlayAll	Plays all messages.		



Group Mailbox Overview

Group Mailboxes provide general delivery of Voicemail messages to a group within an organization. Group Mailboxes are different from your Personal Mailbox in the following ways:

- Messages in Group Mailboxes are not stored in your Deskset. Even if your Personal Mailbox is full, there may be space available in some of your Group Mailboxes.
- The optional Cordless Handset does not support the Group Mailbox feature. The "New Messages" notification on the Handset displays only the new message count from the Personal Mailbox. Group Mailbox subscribers with a Cordless Handset may notice that the New Message counts on the Deskset and Cordless Handset do not match.

If your system administrator has given you access to a Group Mailbox, the # **New Messages** count on the Idle screen includes your new private messages and new messages in any Group Mailboxes to which you are assigned.

If you select # **New Messages**, or press **MESSAGES** and have not enabled Voicemail distribution, a list of mailboxes appears, as shown in Figure 42.

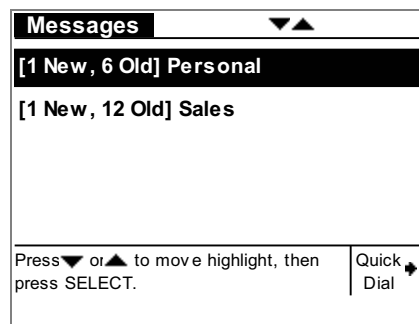

Figure 42. Group Mailbox List

If you press **MESSAGES** and have enabled Voicemail distribution, you will see a screen that allows you to press **Listen** to see the list of mailboxes.

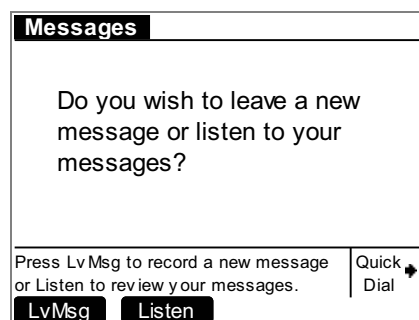

Figure 43. Leave New Message or Listen Screen

From the Mailbox list screen, you can access your personal Voicemail and messages stored in Group Mailboxes, such as the sales department shown in Figure 42. Your Personal Mailbox is always at the top of the list of mailboxes.



Select a mailbox to access the messages stored in that mailbox.

The list of messages in that mailbox appears. When you access a Group Mailbox, the name of the Group Mailbox appears at the top of the screen.

Additionally, the following conditions apply when you access a Group Mailbox:

- When a mailbox is nearly full, [**<5 Min**] appears, and when it is full, [**FULL**] appears next to that Group Mailbox as shown in Figure 44. Delete messages to make more room.

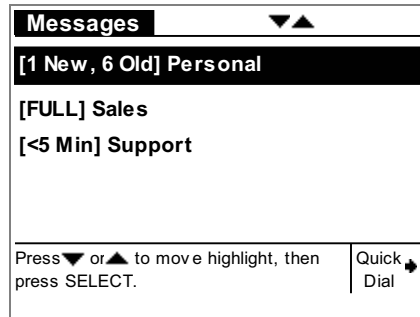

Figure 44. Full Group Mailboxes

- After someone listens to a message, the [NEW] indicator for that message is removed from the screens of all participants of that group.
- If someone else is listening to a message when you delete it, the message is not deleted until the listener exits the Voicemail session.
- Message playback is not interrupted if you receive a call while playing Group Mailbox Voicemail. The incoming call appears on the Deskset screen accompanied by a call-waiting tone. (There is no call-waiting tone in Line Appearance mode.)



Accessing Your Messages

Access to your messages is different depending on whether or not you have access to any Group Mailboxes, and whether you have enabled Voicemail distribution. If you do not have access to a Group Mailbox, and you have not enabled Voicemail distribution, you can access just your new messages by selecting **# New Messages** on the Idle screen. A list of your new messages appears. You can also access all messages (old and new) by pressing **MESSAGES**. A list of all messages appears.

To access an entry from Voicemail:

1. From the Idle screen, press **MESSAGES**. If necessary, use the dial pad to enter your user password and press **SELECT**.



Once you have entered your password, you do not have to enter it again while you are reviewing messages. However, if you exit the **Messages** screen, you will need to enter your password to access the Message list.

The screen that appears depends on your system configuration.

If you do not have Voicemail Distribution enabled or access to a Group Mailbox, the **Messages** list appears.

"New Messages" appears when you select # New Messages from the Idle screen.

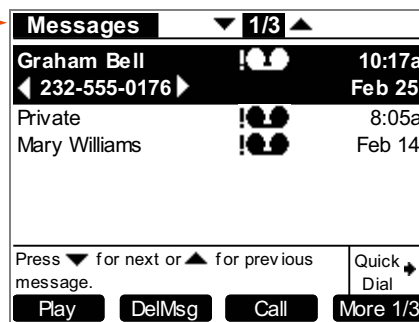

If you have enabled Voicemail Distribution (see ["Voicemail Distribution" on page 211](#)), the **Leave New Message or Listen** screen appears.

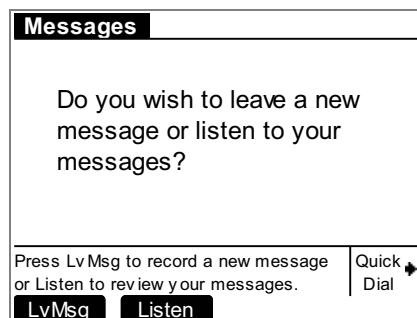

- Press **LvMsg** to create a message to send to a Voicemail Distribution List. See ["Sending a New Message to a Distribution List" on page 138](#).
- Press **Listen** to view the Mailbox List (if you have Group Mailboxes), or the **Messages** list.



If your system administrator has assigned a Group Mailbox to you, a list of your Personal Mailbox and Group Mailboxes appears.

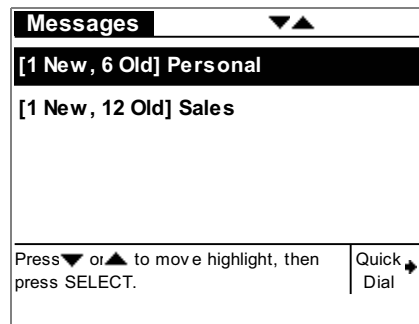

- a. If necessary, press ∇ or \triangle to highlight the desired Mailbox.
 - b. Press **SELECT**. The **Messages** list appears.
2. Press ∇ or \triangle until you highlight the desired **Messages** entry.
 3. Press **CANCEL** to exit the Voicemail list.

To view your Voicemail with the Cordless Handset, see [“Accessing Personal Voicemail with the Cordless Handset” on page 145](#). Voicemail Distribution and Group Mailboxes are not supported on the Cordless Handset.

Message Playback

You can play either a single message or all of the Voicemail messages in a Mailbox.

To play new messages:

1. On the Idle screen, select **# New Messages**. The **New Messages** list appears.

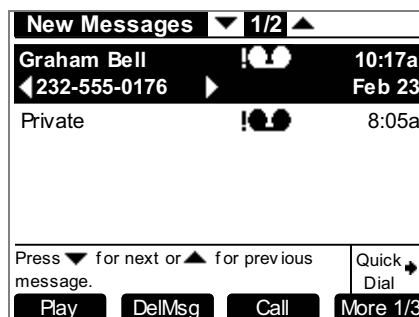

2. Press ∇ or \triangle to highlight the desired message, then press **Play**.

OR

Press **More 1/3**, then press **PlayAll**. All messages begin to play, starting with the oldest. There is a short beep between messages.

NEW appears on messages that are being played for the first time.





During message playback, you can pick up the handset to listen to messages privately, or press:

- **Pause** to pause message playback.
- **Delete** to delete the message. If there are more messages, the next message is highlighted.
- **◀ Jump** or **Jump ▶** to skip back or forward by 8 seconds.
- ▼ or ▲ to skip to the previous or next message.
- **CANCEL** to cancel playback and leave the highlight on the last played message.

To do this with the Cordless Handset, see ["Retrieving Personal Voicemail with the Cordless Handset" on page 147](#).

To play old and new messages:

1. Press **MESSAGES** to view the entire **Messages** list, as described in ["Accessing Your Messages" on page 131](#). The list is sorted with the newest messages at the top of the list.
2. To play a specific message only, press ▲ or ▼ to highlight the desired message, then press **Play**.

OR

To play all messages, press **More 1/3** and then press **PlayAll**.

The Message Playback screen appears.

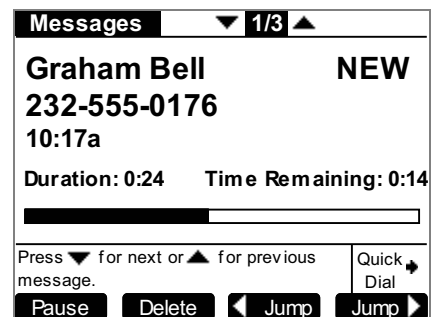

During message playback, you can pick up the handset to listen to messages privately, or press:

- **Pause** to pause message playback.



- **Delete** to delete the message. If there are more messages, the next message is selected.
- **◀ Jump** or **Jump ▶** to skip back or forward by 8 seconds.
- ▽ or △ to skip to the previous or next message.
- **CANCEL** to cancel playback and leave the highlight on the last played message.



Forwarding a Message

You can forward a message to an extension or extensions, a Voicemail Distribution List (if enabled), or a Group Mailbox (if enabled). You can also record a message and forward it to a Distribution List.

- [“Forwarding a Voicemail Message”](#)
- [“Recording an Introduction to Send with a Forwarded Message” on page 137.](#)

Forwarding a Voicemail Message

You have several options for forwarding a message, depending on how your system has been set up.

To forward a Voicemail message:

1. Open a **Messages** list, as described in [“Accessing Your Messages” on page 131.](#)
2. Press ∇ or \triangle to highlight the desired message.
3. Press **More 1/3** to display the **FwdMsg** soft key.

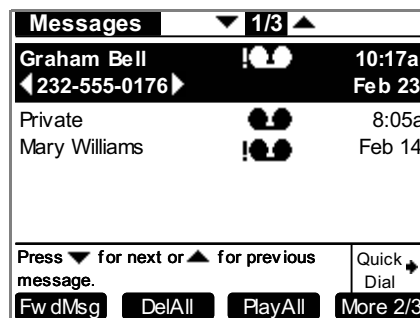

4. Press **FwdMsg** to begin the forwarding process. The **Forward Message** screen appears.

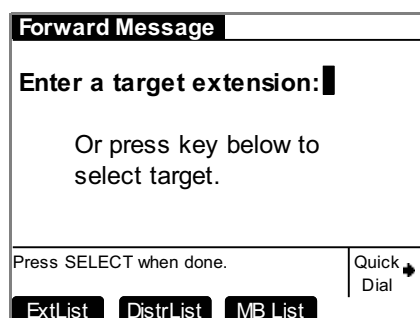

5. Select a target for the forwarded message. Enter an extension number using the dial pad, or:
 - Press **ExtList** to display the **Extension List**. Press ∇ or \triangle to highlight the desired extension and press **SELECT**. The **Forward Message** screen appears. Go to Step 6.



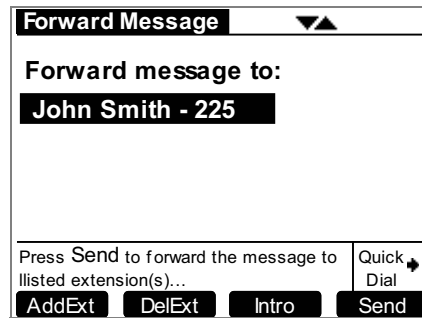

- If you have enabled Voicemail Distribution, you can press **DistrList** to display Voicemail Distribution Lists. Press Δ or ∇ to highlight the desired **Distribution List** and press **SELECT**. The **Forward Message** screen appears. Go to Step 7.
 - If your system has Group Mailboxes, you can press **MBList** to display the Group Mailbox list. Press Δ or ∇ to highlight the desired Mailbox and press **SELECT**. The **Forward Message** screen appears. Go to Step 7.
6. Before forwarding the message, you can press:
 - **AddExt** to add another extension. Messages can be forwarded to three extensions simultaneously. Enter the desired extension and press **SELECT**.
 - **DelExt** to remove the currently highlighted extension from the list.
 7. Optional: **Intro** to record an introductory message. See [“To record a message introduction:” on page 137](#).
 8. Press **Send** to forward the message.

The **Message Forwarded** message appears. The forwarded message appears in the recipient's Messages list.



To forward a message to an extension with the Cordless Handset, see [“Managing Personal Voicemail with the Cordless Handset” on page 149](#).



Recording an Introduction to Send with a Forwarded Message

You can record an audio introduction to send with a forwarded message. To begin recording the introduction, press **Intro** while forwarding a message.

To record a message introduction:

1. Press **Intro** after selecting the target for a forwarded message. The **Message Introduction** screen appears.

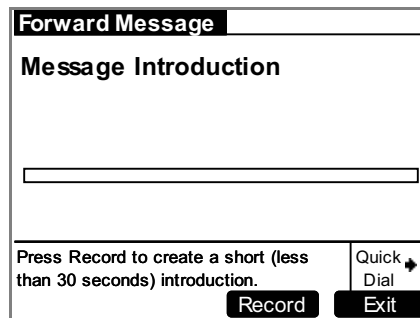

2. Press **Record** to begin recording. The soft key changes to **Stop** and the word **RECORDING** appears.

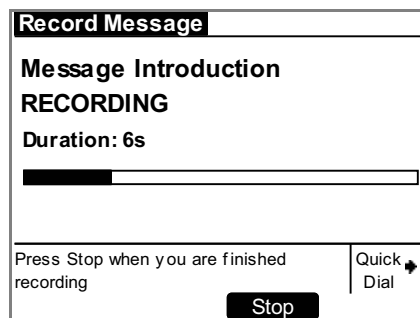

3. When finished recording, press **Stop**. Reaching the 30-second limit automatically stops recording. The message review screen appears.

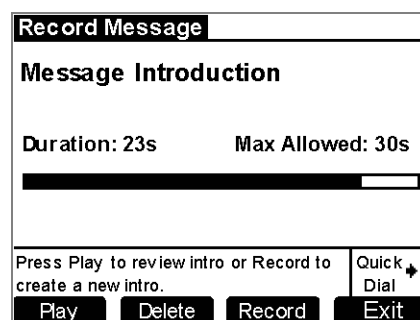

You have options to play, delete, and record the announcement again.

4. Press **Exit**. The Forward Message screen with **[Message Introduction Attached]** appears on the screen.
5. Press **Send** to forward the message with the introduction message attached.



Sending a New Message to a Distribution List

If you have enabled Voicemail Distribution and created at least one Distribution List, you can record a new message and send it to a Distribution List. To create a Distribution List, see ["Voicemail Distribution" on page 211](#).

To record and send a new message:

1. Press **MESSAGES**. With Voicemail Distribution enabled, the **Leave New Message or Listen** screen appears.

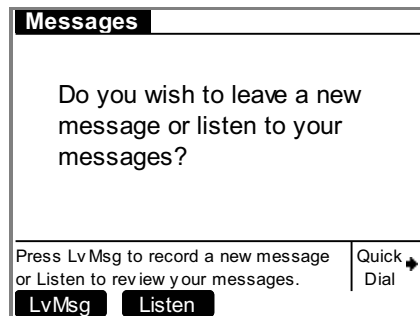

2. Press **LvMsg**. The **Distribution Lists** screen appears.

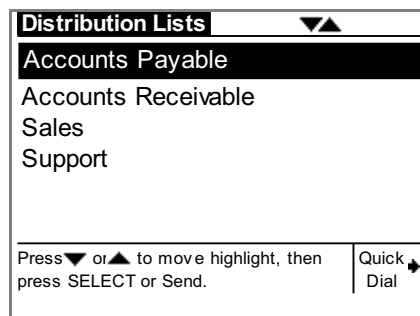

3. Press **▲** or **▼** to highlight the desired Distribution List.
4. Press **SELECT**. The **Record Message** screen appears.

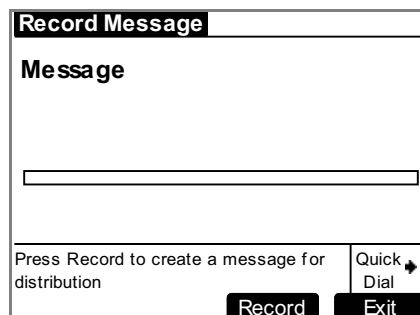

5. Press **Record** to begin recording. The soft key changes to **Stop** and the word **RECORDING** appears.



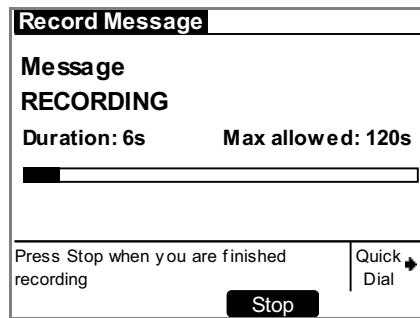

OR

Press **Exit** to return to the previous screen.

- When finished recording, press **Stop**. The message review screen appears.

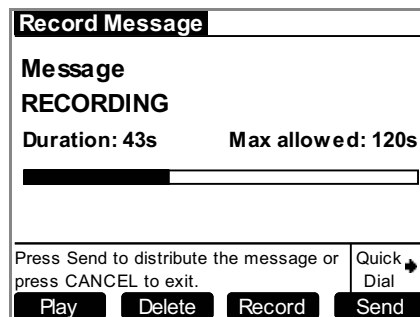

Reaching the 120-second limit automatically stops recording.

You have options to **Play**, **Delete**, and **Record** the message again.

- Press **Send** to forward the message.



Deleting Messages

You can delete a single message or all messages from the **Messages** list. You can also delete a single message during message playback as described in ["Message Playback" on page 132](#).

To delete a single message or all messages:

1. Open a **Messages** list, as described in ["Accessing Your Messages" on page 131](#).
2. Press \triangle or ∇ to highlight the desired message.
3. Press **DelMsg** to delete the message.

The system removes the message from the list and highlights the next message.

OR

To delete all messages:

- a. Press **More 1/3** and then press **DelAll**.

The confirmation screen appears.

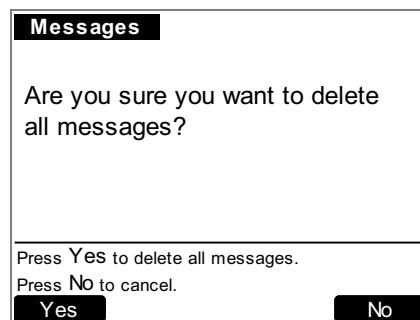

- b. Press **Yes** to confirm.



NOTE

All messages are deleted, whether they are new (unheard) or not.

To do this with the Cordless Handset, see ["Managing Personal Voicemail with the Cordless Handset" on page 149](#).



New Message Status Indications (! Icons)

You can add a new message indication (! icon) or delete all new indications from the **Messages** list. Messages display with an exclamation point to indicate that the message has not been played.

To clear and restore new message indications:

1. Open the **Messages** list, as described in ["Accessing Your Messages" on page 131](#). A Messages list appears.
2. Press **More 1/3** then **More 2/3** to display the **ClerNew** and **MrkNew** soft keys.

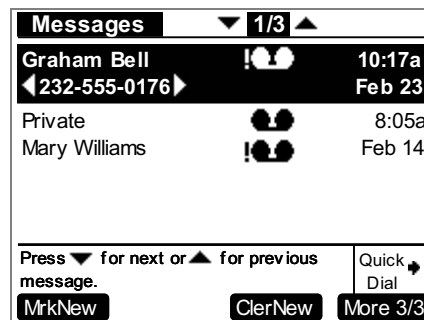

3. Press **ClerNew** to clear all new message indications and display the Message list without exclamation points. The MESSAGE WAITING LED turns off.

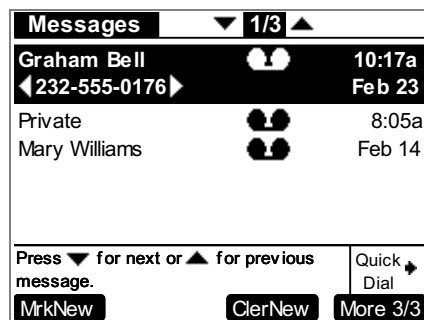

4. If desired, press **MrkNew** to restore the ! icon for a selected message, marking the message as new again. The MESSAGE WAITING LED lights up again.



Accessing Your Voicemail Remotely

Remote access allows you to listen to Personal Messages or change the recorded greeting when you are away from your Deskset. Follow the voice prompts and press the appropriate dial-pad keys to navigate through the system. The voice prompts in a menu list are repeated three times with a 5-second pause between. After three times with no action, the voice says "Goodbye" and the remote call is disconnected.

Listening to the time/date stamp information of a message does not count as listening to the message. If you access the Voicemail through remote access and skip to another message while the time or date is playing, the message is still considered new.



- This feature applies to Call Appearance mode only.
 - NOTE** ■ You cannot remotely access Group Mailboxes.
-

To access Voicemail remotely:

1. Dial your company phone number.
2. After the call is answered, enter your extension number.
3. Immediately press the star twice (* *). You will hear, "Enter your access code, followed by the pound sign."
4. Enter your user password (if you have created one), then enter pound (#) to listen to your messages.

Even if you have not created a password, you must still enter the pound (#) after entering nothing for your password.



- NOTE** You need to get to your Personal Mailbox to access your messages remotely. If Call Forward All or Call Forward–No Answer is on and set to an extension or an outside line, or if Auto Answer is on, remote access to Voicemail is not supported as calls do not access your mailbox.
-

To access Voicemail remotely – listen to messages:

Once you have accessed the system, the Main Menu plays. From this menu you can listen to old or new messages as illustrated in Figure 45. You have the following options:

- To listen to new messages, press **1**.
- To listen to old messages, press **2**.

Once you press 1 or 2, and the messages start playing, you have the following options:

- To change Voicemail options, press **8**.
- To stop message playback and replay options, press **5**.
- To delete the current message, press **3**.
- To repeat the previous message, press **4**.
- To skip this message, press **6**.
- To jump back 8 seconds, press **7**.



- To jump forward 8 seconds, press **9**.
- To return to the previous menu, press star *****.

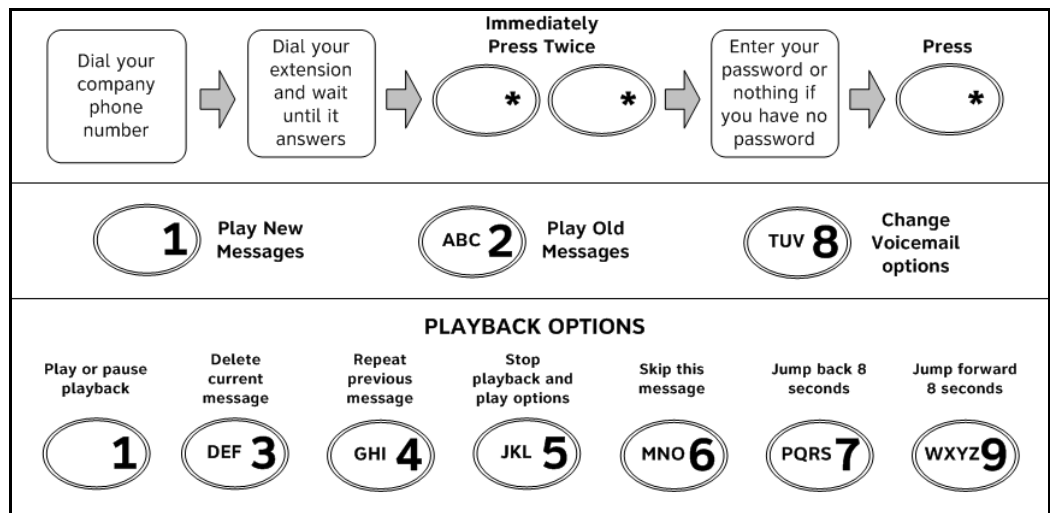

Figure 45. Remote Voicemail Access

To access Voicemail remotely – Voicemail greeting setup:

- To set up the Voicemail greeting, access the system and press **8**. As illustrated in the flow diagram in Figure 46, you have the following options:
 - To record a primary greeting, press **1**.
 - To record an alternate greeting, press **2**.
 - To choose the Primary or Alternate greeting, press **7**.
- Begin recording after the tone.
- To end the recording, press **5**.
- Select one of the following options:
 - To review the recording, press **1**.
 - To record over the greeting, press **3**.
 - To accept the greeting, press **9**.



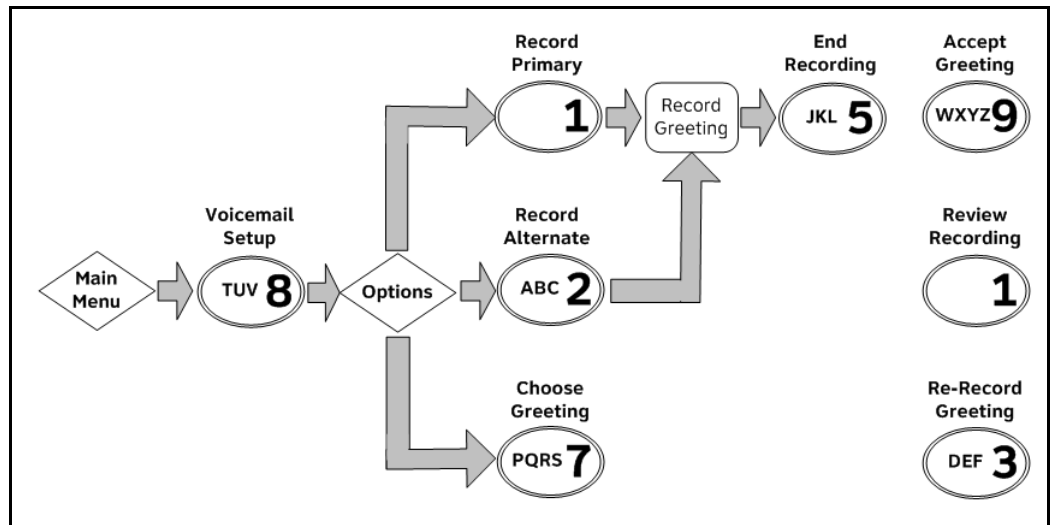

Figure 46. Remote Voicemail Greeting Setup

Accessing Personal Voicemail with the Cordless Handset



Cordless Handset operation is compatible with Call Appearance mode only.

You can also access your personal Voicemail with the optional SB67040 Cordless Handset:

- ["Voicemail Notification on the Cordless Handset" on page 146](#)
- ["Retrieving Personal Voicemail with the Cordless Handset" on page 147](#)
- ["Reviewing Messages with the Cordless Handset" on page 148](#)
- ["Managing Personal Voicemail with the Cordless Handset" on page 149.](#)



Voicemail Notification on the Cordless Handset

Unanswered incoming calls are handled according to the Call Forward–No Answer setting. The default setting is to send the calls to personal Voicemail. You can also forward a ringing call to your personal Voicemail by pressing **FWD-VM**, as shown in Figure 47.



You cannot forward Call Queue calls to Voicemail. Pressing **FWD-VM** on a Call Queue call causes the call to continue, but the screen will appear to be in Idle mode. The Handset returns to Idle mode when you press **OFF** to end the call.



Figure 47. Incoming Call

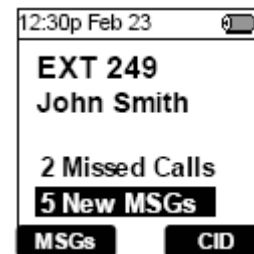

Figure 48. Voicemail Notification

If a caller leaves a personal Voicemail message, the Idle screen displays a **New MSGs** indication, as shown in Figure 48.

Once the new message is reviewed in the Voicemail records, the Cordless Handset updates the Idle screen notification.



Messages left in Group Mailboxes are not displayed on or accessible from the Cordless Handset.



Retrieving Personal Voicemail with the Cordless Handset

To retrieve personal Voicemail:

1. Press **MSGs** from the Idle screen shown in [Figure 48 on page 146](#) to retrieve all personal Voicemail. The message review screen appears.

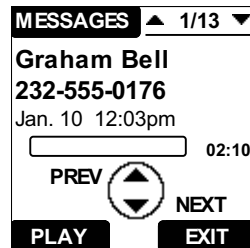

OR

When # **New MSGs** is highlighted, press **SELECT** to play new Personal Messages. The New Message review screen appears.



If you have created a user password, you are prompted to enter it.

NOTE

2. Press **PLAY** to begin playing the Voicemail (see [“Reviewing Messages with the Cordless Handset” on page 148](#)) or press **EXIT** to return to the Idle screen.



Reviewing Messages with the Cordless Handset

To review messages:

1. Press **PLAY** to begin Voicemail message playback. The message begins playing, as shown below.

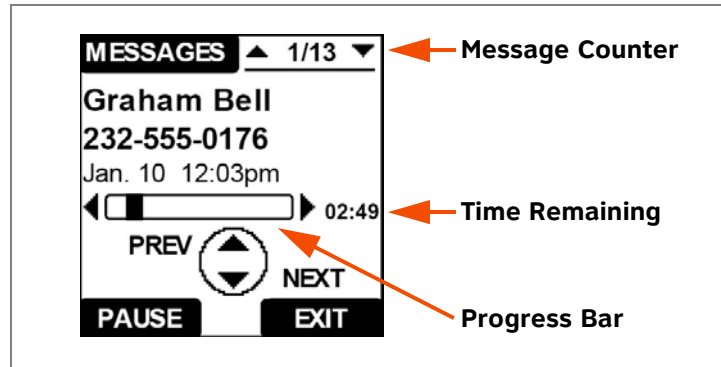

Once message playback starts:

- The **PLAY** soft key becomes **PAUSE**.
 - The message progress bar indicates how much of the message has played.
 - The message timer displays the remaining time, in seconds, of message playback.
 - Press **SPEAKER** to hear message playback through the speaker.
 - Press ◀ to jump back eight seconds.
 - Press ▶ to jump forward eight seconds.
 - Press △ to play the previous message.
 - Press ▽ to play the next message.
2. Press **PHONE** to exit message playback and call the phone number from the message.



For outside phone numbers in Voicemail and CID lists, Synapse dials a 9 or whatever digit, if any, that must be dialed first and then dials the number in the display. Therefore, numbers that need editing (adding a preceding 1 or a country code, or removing the area code) cannot be dialed from Voicemail.

3. Press **EXIT** to return to Idle mode.

To do this with the Deskset, see ["Message Playback" on page 132](#).



Managing Personal Voicemail with the Cordless Handset

You can delete a message or forward a message to an internal extension.

To delete a message:

1. While viewing or playing a message, press **OPTIONS**. The **OPTIONS** menu appears.

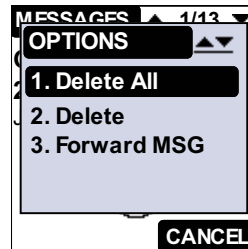

2. Choose one of the following options:
 - To delete all of your messages:
 - a. Press **1**. The confirmation screen appears.



- b. Press **YES** to confirm. Press **NO** to cancel.

- To delete the selected message, press **2**.

A Message Deleted screen briefly appears. You then return to the message review screen.



To forward a message:

1. While viewing or playing a message, press **OPTIONS**. The **OPTIONS** menu appears.

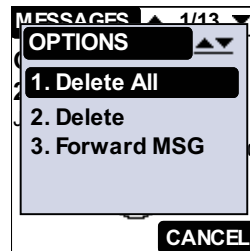

2. Press **3**. The Message Forward screen appears.

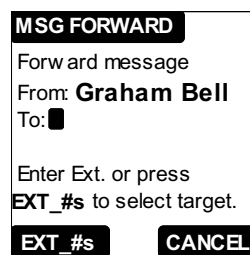

3. Enter an Extension number using the dial pad.

ORPress **EXT_#s** to display the Extension list.

- Press ∇ or \triangle to highlight the desired extension, then press **SELECT**.

OR

- Use the dial pad to find the desired entry by name. See [“Deskset Dial-Pad Entry” on page 23](#).

Once you have selected the target, **SEND** appears.**NOTE**

On Cordless Handsets with software version prior to H034, you cannot forward messages to four-digit extension numbers. To check the software version, see [“Viewing the Cordless Handset Product ID” on page 201](#).

You cannot forward messages from the Cordless Handset to Group Mailboxes or Distribution Lists.

4. Press **SEND** to forward the message to the selected extension.

A confirmation screen appears, confirming that the message has been forwarded. The Handset returns to the same message screen.



CHAPTER
8

CALL LOG

The Deskset Call Log provides available name and number information for the last 50 calls received. The newest entries replace the oldest.

- [“Using the Call Log” on page 152](#)
- [“Managing Missed Calls” on page 154](#)
- [“Reviewing the Call Log List” on page 155](#)
- [“Storing Call Log Entries” on page 157](#)
- [“Deleting Call Log Entries” on page 158.](#)

You can view the Call Log shown in [Figure 49 on page 152](#) by pressing **CALL LOG**. In Call Appearance mode, you can view the unanswered calls that you have not yet seen by highlighting **# New Missed Calls** on the Idle screen and pressing **SELECT**.

You can also access the Call Log with an optional Cordless Handset. See [“Accessing the Call Log with the Cordless Handset” on page 160](#).

**NOTE**

This system has a caller ID feature that works with the caller identification service offered through your telephone service provider. There is a fee for this service, and it might not be available in all areas. This telephone can provide information only if both you and the caller are in areas offering caller identification service, and if both telephone service providers use compatible equipment.



Using the Call Log

The Call Log soft keys, as shown in Figure 49 and described in Table 22, are available whenever the Call Log has at least one entry.

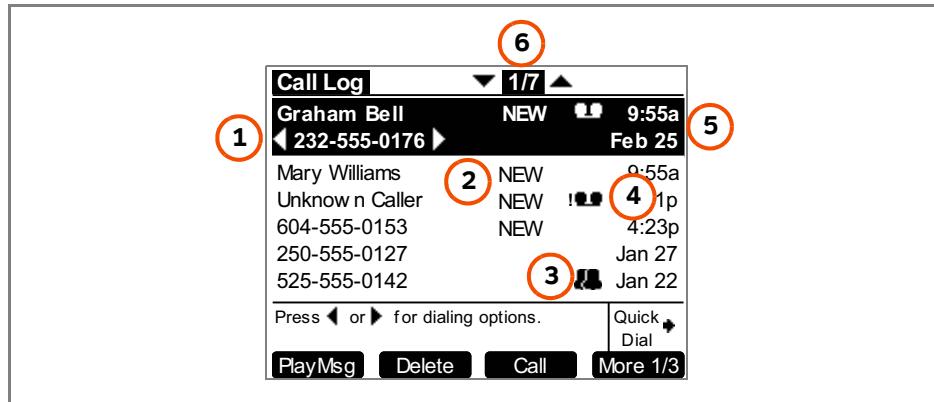

Figure 49. Call Log Functions

1. Arrows	Indicate dialing options available.
2. NEW	Indicates call was not answered and has not been reviewed.
3. Ring Group or Call Queue	Indicates a call to a Ring Group or Call Queue. The Voicemail icon replaces this icon when both would apply.
4. Voicemail message available for playback.	Exclamation mark (!) indicates message is new.
5. Time and date of highlighted call entry	Moves the cursor up/down/left/right on the display.
6. Current Call Log entry number/ total number of entries	

Table 22. Call Log Soft keys

Key	Description	Key	Description
PlayMsg	Plays message. Only present when there is a message recorded.	Delete	Deletes the highlighted entry.
Call	Dials the highlighted entry.	Store	Stores number in your Personal list.
DelAll	Deletes all entries.	ClerNew	Marks all new calls as old.
Details	Shows you more details.	More	Moves to the next set of soft keys. More 1/3 indicates that you are on page one of three.



- Entries not highlighted display the time for calls received on the current day. Calls before the current day display the date.
- If the caller ID information is absent because it is unavailable, UNKNOWN NAME and UNKNOWN NUMBER appear. If the caller chooses not to send the information, PRIVATE NAME and PRIVATE NUMBER appear.

To access the Call Log list:

1. From the Idle screen, press **CALL LOG**. The Call Log list appears with the most recent entry at the top.
 - To view details for a Call Log entry, press **More 1/3**, then **More 2/3**, then **Details**. The Call Log details screen appears.

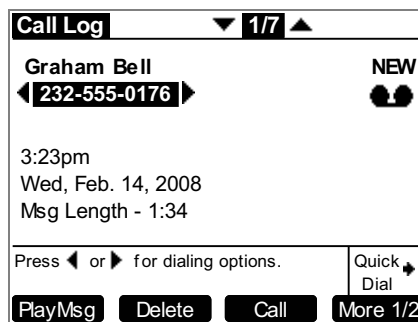

- Call Log entries may not be in the proper format for dialing. In some areas, you need to remove the area code or add or remove a 1. Press **<** or **>** to view the dialing options.
2. Press **CANCEL** to exit the Call Log.



NOTE

Whatever digit, if any, that must be dialed first to indicate this is an outside call is automatically added before the number is dialed out.

To do this with the Cordless Handset, see ["Accessing the Call Log with the Cordless Handset" on page 160.](#)



Managing Missed Calls

All incoming calls are recorded in the Call Log unless Call Forward All is on and calls are forwarded to another extension or outside phone number (Call Appearance mode only). Unanswered calls that have not been reviewed are indicated by **NEW**.

To view missed calls:

1. Press **CALL LOG**. The newest call appears first.

Call Appearance mode only — The Deskset notifies you of **New Missed Calls** on the Idle screen. To display the New Missed Calls list, highlight **# New Missed Calls** and press **SELECT**.

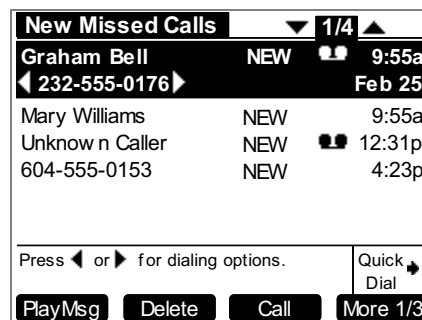

- A call record is no longer considered new once you highlight it.
- Once a new call is reviewed, the **# New Missed Calls** is reduced by one.

To do this with the Cordless Handset, see [“Managing Missed Calls with the Cordless Handset” on page 162](#).



Reviewing the Call Log List

To review the Call Log list:

1. Press **CALL LOG** to display the **Call Log**.

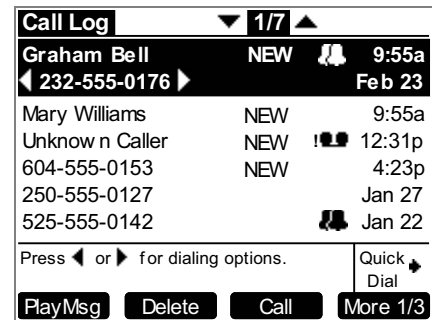
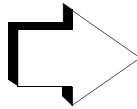
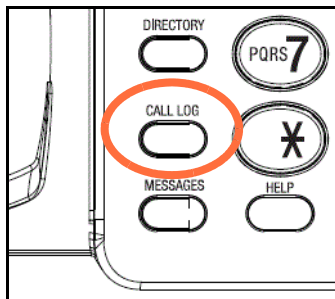

2. Press ∇ or \triangle to highlight the desired **Call Log** entry.
 - Press **Call** to dial the highlighted number in the **Call Log**.
 - **Call Log** entries may not be in the proper format for dialing. In some areas, you need to remove the area code or add or remove a 1. Press \triangleleft or \triangleright to view the dialing options. The following dialing options are available:
 - nnn-nnnn (7 digits)
 - 1-nnn-nnnn (8 digits)
 - nnn-nnn-nnnn (10 digits)
 - 1-nnn-nnn-nnnn (11 digits).
 - Press **Delete** to delete the selected entry.
 - To view details for any entry, see ["To access the Call Log list:" on page 153.](#)
3. Press **CANCEL** to exit the **Call Log**.

To do this with the Cordless Handset, see ["Reviewing the Call Log with the Cordless Handset" on page 162.](#)



Listening to Voicemail From the Call Log

If the caller left a Voicemail message, you can play the message from the Call Log list or from Call Log Details.

To play a Voicemail message from the Call Log:

1. Press **CALL LOG** to display the Call Log.

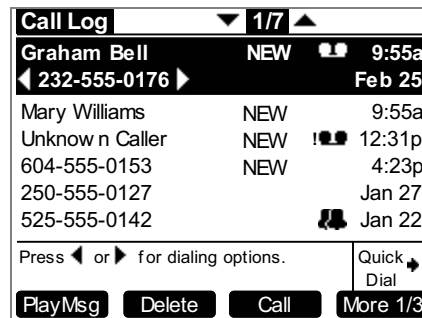

2. Press ∇ or \triangle to highlight the desired message, then press **PlayMsg**. The message review screen appears.

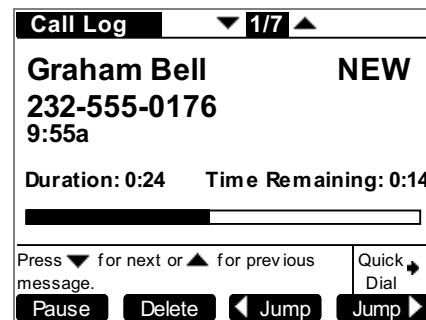

PlayMsg only appears if the call has an associated Voicemail.

If necessary, use the dial pad to enter your user password and press **SELECT**.

3. Press **Delete** while the message is playing to delete the voice message. There is a slight delay until the message indicators change.
4. When the message playback completes, the **Call Log** appears.
5. Press **CANCEL** to exit the **Call Log**.

To do this with the Cordless Handset, see ["Playing Voicemail Messages in the Call Log with the Cordless Handset" on page 163](#).



Storing Call Log Entries

To store a Call Log entry into your Personal list:

1. From the desired Call Log entry, press **More 1/3** to view the **Store** soft key.
2. Press **Store** to store the entry in your Personal list. The **Personal Entry** screen appears.

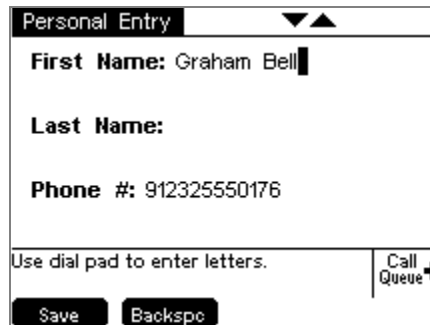

The screenshot shows a screen titled "Personal Entry" with a dropdown arrow on the right. It contains three text input fields: "First Name: Graham Bell", "Last Name:", and "Phone #: 912325550176". Below the fields is a prompt "Use dial pad to enter letters." and a "Call Queue" button with a right-pointing arrow. At the bottom are "Save" and "Backspc" buttons.

The caller information fills in the **First Name** and **Number** fields.

3. To enter the Last Name, press ∇ and use the dial pad to enter letters. See ["Deskset Dial-Pad Entry" on page 23](#).
4. Press ∇ and edit the Number if necessary.



When entering a phone number, you must add a **9**, or whatever digit, if any, that must be dialed first to indicate this is an outside call, and **1** if it is a long-distance number.

The system does not check for duplicate entries.

5. Press **Save** to store the entry and return to the **Call Log**.
6. Press **CANCEL** to exit the **Call Log**.



Deleting Call Log Entries

You can delete a single Call Log entry, or all Call Log entries.

To delete a single Call Log entry:

1. From a highlighted Call Log entry, press **Delete**. The entry is removed from the list and the next entry is highlighted.
2. Press **CANCEL** to exit the Call Log.

To do this with the Cordless Handset, see ["Deleting Call Log Entries with the Cordless Handset" on page 163](#).

You can delete all entries only when viewing the Call Log list from Idle mode.

To delete all Call Log entries:

1. From the Call Log, press **More 1/3** to display the **DelAll** soft key.



2. Press **DelAll** to delete all entries in the **Call Log**. The confirmation screen appears.

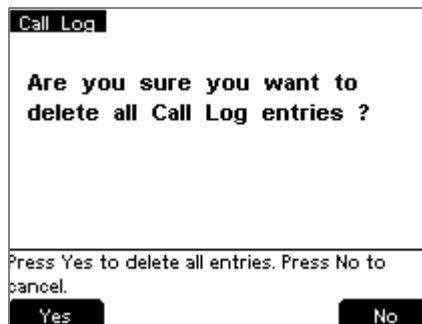

3. Press **Yes** to confirm the deletion. The empty Call Log appears.

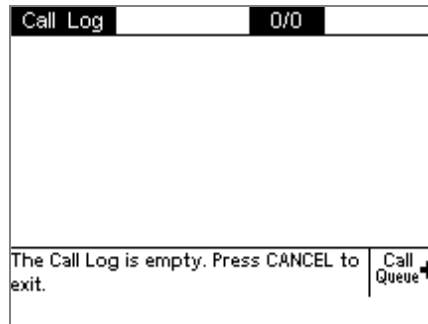

4. Press **CANCEL** to exit the **Call Log**.

To do this with the Cordless Handset, see ["Deleting Call Log Entries with the Cordless Handset" on page 163](#).



Accessing the Call Log with the Cordless Handset

**NOTE**

Cordless Handset operation is compatible with Call Appearance mode only.

You can also access the Call Log with the optional SB67040 Cordless Handset.

- ["Using the Call Log with the Cordless Handset" on page 161](#)
- ["Managing Missed Calls with the Cordless Handset" on page 162](#)
- ["Reviewing the Call Log with the Cordless Handset" on page 162](#)
- ["Playing Voicemail Messages in the Call Log with the Cordless Handset" on page 163](#)
- ["Deleting Call Log Entries with the Cordless Handset" on page 163.](#)

You can display the entire Call Log shown in [Figure 50 on page 161](#) by pressing **CID**. You can display the missed calls that you have not yet seen by highlighting **# Missed Calls** in the Idle screen and pressing **SELECT**.

**NOTE**

The caller ID feature works with the caller identification service offered through your telephone service provider. There is a fee for this service, and it might not be available in all areas. The Cordless Handset can provide information only if both you and the caller are in areas offering caller identification service, and if both telephone service providers use compatible equipment.



Using the Call Log with the Cordless Handset

The Handset Call Log functions are shown in Figure 50.



Figure 50. Call Log Functions

1. Arrows	Indicate dialing options available.
2. NEW	Indicates call was not answered and has not been reviewed.
3. Voicemail message available for playback.	Exclamation mark (!) indicates message is new.
4. Time and date of highlighted call entry	Moves the cursor up/down/left/right on the display.
5. Current Call Log entry number/ total number of entries	

- Entries not highlighted display the time for calls received on the current day. Calls before the current day display the date.



NOTE

Before a Call Log number is dialed, the system automatically inserts whatever digit, if any, that must be dialed first to indicate this is an outside call.



Managing Missed Calls with the Cordless Handset

The Cordless Handset records incoming call information in the Call Log and displays a notification on the Idle screen. Unanswered calls that have not been reviewed are considered missed. Once you review a call, the new missed-call count goes down by one.

To view missed calls:

1. On the Idle screen, highlight # **Missed Calls**, then press **SELECT**.

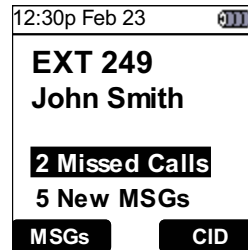

2. Press ∇ or \triangle to scroll through the Missed-Call entries.

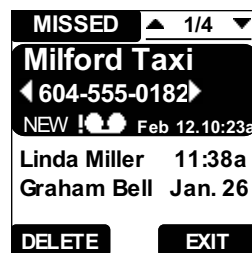

- Press **DELETE** to delete the highlighted call entry.
- Press **EXIT** to return to the previous mode.

If caller ID is unavailable, the Call Log and Missed-Call list entries display the name as **UNKNOWN**.

Reviewing the Call Log with the Cordless Handset

To review and dial from the Call Log:

1. Press **CID** to display the Call Log.

OR

To access the **Call Log** during a call, press **OPTIONS** and then **6**.

2. Press ∇ or \triangle to scroll to the desired Call Log entry.
3. Press **SELECT** or **PHONE** to dial the highlighted Call Log entry. If you are accessing the Call Log from Idle mode, pressing **SPEAKER** also dials the selected number.

Call Log entries may not be in the proper format for dialing. In some areas, you need to remove the area code or add or remove a 1. Press \triangleleft or \triangleright to view the dialing options.

4. Press **DELETE** to delete the selected entry.



Playing Voicemail Messages in the Call Log with the Cordless Handset

If the caller left a Voicemail message, you can play the message from the Call Log.

To play a Voicemail message from the Call Log:

1. Press **CID** to display the Call Log.
2. Press ∇ or \triangle to highlight the desired message.
3. Press **OPTIONS** to display the Call Log Options.

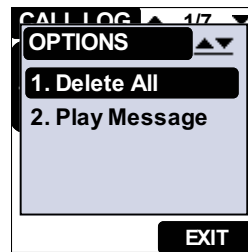

4. Press **2** to play the message.
If necessary, use the dial pad to enter your user password and press **SELECT**.
5. When the message playback completes, the Call Log appears.

Deleting Call Log Entries with the Cordless Handset

You can delete a single Call Log entry, or all Call Log entries.

To delete a single Call Log entry:

1. Press **CID** to display the Call Log.
OR
To access the Call Log during a call, press **OPTIONS** and then **6**.
2. Press ∇ or \triangle to highlight the desired message.
3. Press **DELETE**. The highlighted entry is removed from the list and the next entry appears.



To delete all of the entries in the Call Log:

1. Press **CID** to display the Call Log.

OR

To access the Call Log during a call, press **OPTIONS** and then **6**.

2. Press **OPTIONS** to display the Call Log Options.

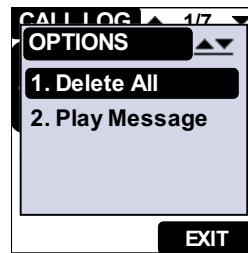

3. Press **1** or **SELECT** to display the Delete-All Confirmation screen.

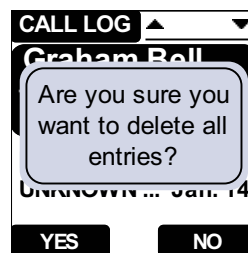

- Press **YES** to delete all Call Log entries.
- Press **NO** to return to the Call Log screen.



CHAPTER
9

PAGING

Paging allows you to broadcast what you say to more than one extension. If your system administrator has set up Paging Zones, you can page all extensions or a zone.

If your Synapse system includes an optional overhead paging (OHP) system, you may be able to page through loudspeakers. If the OHP is a single-zone paging system, it is included when you page **All Extensions**. The single-zone OHP may also be included in an individual Paging Zone. If the OHP is a multi-zone paging system, it is not included when you page all extensions. However, it appears as **Overhead Page** as the last entry in the **Paging Zones** list.

- ["Paging All Extensions or a Paging Zone" on page 166](#)
- ["Single-Zone Overhead Paging" on page 167](#)
- ["Multi-Zone Overhead Paging" on page 168](#)
- ["Paging with the Cordless Handset" on page 169.](#)



Paging All Extensions or a Paging Zone

If your system administrator has set up Paging Zones, you can page all extensions or a zone.

To page all extensions or a Paging Zone:

1. From Idle or from a held call, press **Page**. It may be necessary to press **More 1/2** from Idle, or to press **More 1/3**, then **More 2/3** from Hold.

The **Paging Zones** screen appears.

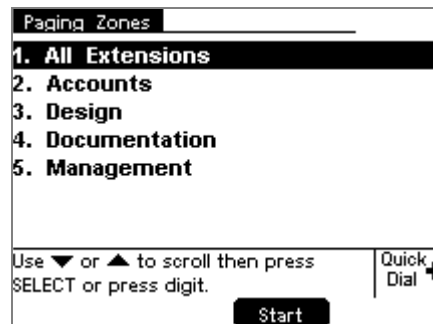

2. Select **All Extensions** or a Paging Zone.
3. Press **Start**. The system emits a short paging tone and displays the **Page** screen.

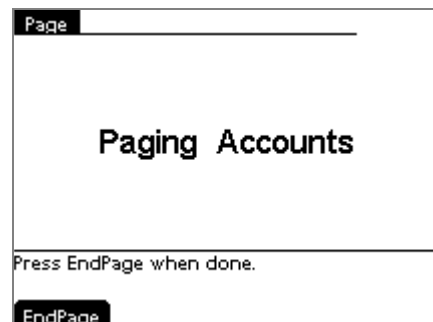

4. Speak into the speakerphone or pick up the corded handset to speak.
5. When finished, press **EndPage**, hang up the handset, or press **SPEAKER**. The Idle screen appears.

At the extensions being paged:

- Desksets involved in active calls, listening to a Voicemail message, or playing or recording a name or greeting do not receive pages.
- Press the **VOL+** or **VOL-** keys to adjust the volume. This volume setting affects current and future incoming pages only.
- Lifting the handset cancels the page.
- To page with the Cordless Handset, see [“Paging with the Cordless Handset” on page 169](#).



Single-Zone Overhead Paging

If your Synapse system includes an optional single-zone overhead paging (OHP) system, your system administrator may have set up an overhead paging option in the Paging Zones list, such as for your warehouse. The OHP speakers are included when you page **All Extensions**, and they may be included in other Paging Zones.

To page using a single-zone overhead paging system:

1. From Idle or from a held call, press **Page**. It may be necessary to press **More 1/2** from Idle, or to press **More 1/3**, then **More 2/3** from Hold.

The **Paging Zones** screen appears.

2. Select the appropriate zone.
3. Press **Start**. The system displays the **Page** screen.
4. Wait for feedback from your paging system, then speak into the speakerphone or pick up the corded handset to speak.
5. When finished, press **EndPage**, hang up the handset, or press **SPEAKER**. The Idle screen appears.



Multi-Zone Overhead Paging

If your Synapse system includes an optional multi-zone overhead paging (OHP) system, you have an **Overhead Paging** option in the Paging Zones list.

To page using an optional multi-zone overhead paging system:

1. From Idle or from a held call, press **Page**. It may be necessary to press **More 1/2** from Idle, or to press **More 1/3**, then **More 2/3** from Hold.

The **Paging Zones** screen appears.

2. Select **Overhead Paging**.
3. Press **Start**. The multi-zone **Overhead Page** screen appears. If necessary, enter the desired overhead Paging Zone number.



4. Wait for feedback from your paging system, then speak into the speakerphone or pick up the corded handset to speak.
5. When finished, press **EndPage**, hang up the handset, or press **SPEAKER**. The Idle screen appears.



Paging with the Cordless Handset



Cordless Handset operation is compatible with Call Appearance mode only.

You can page all the extensions in the system.



Zone paging and (optional) overhead paging are not available from the Cordless Handset.

To page all extensions with the Cordless Handset:

1. From a held call or Idle mode:
 - a. Press **OPTIONS**. The **OPTIONS** menu appears.

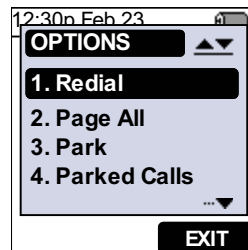

- b. Press **2** to begin the page. The **Paging** screen appears.

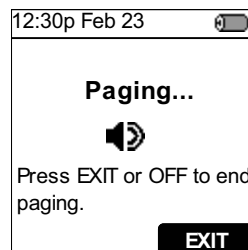

OR

From the Parked Call list, press **PAGE** to begin the page.

The Handset originating the page emits a single short tone for half a second just before paging commences. An alert tone also sounds on all paged extensions.

2. Speak into the microphone on the handset.
3. Press **EXIT** or **OFF** to end paging.



CHAPTER
10

DESKSET SETTINGS

You or your system administrator can customize your Deskset and SB67040 optional Cordless Handset using the following menus and features:

- ["Deskset Menu" on page 171](#)
- ["Deskset Settings" on page 172](#)
- ["User Settings" on page 176](#)
- ["Setting and Changing Your Password" on page 191](#)
- ["Deskset Information" on page 194](#)
- ["Using Do Not Disturb \(DND\)" on page 195](#)
- ["Auto-Attendant Settings" on page 196](#)
- ["Cordless Handset Settings" on page 198.](#)



Deskset Menu

You can use the Deskset menus to set up many Deskset features. Access the **Menu** by pressing **MENU**, and then select options by highlighting an item and pressing **SELECT**, or by pressing the dial-pad key with that option number.

To access the Deskset setup menus:

Press **MENU**. The Deskset **Menu** appears.

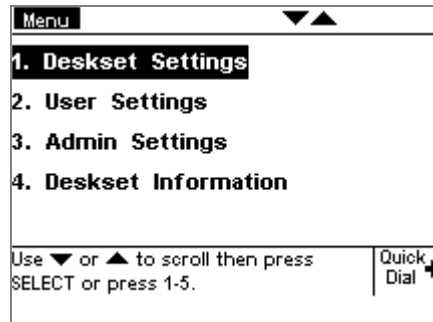

- Press **1** on the dial pad to display the **Deskset Settings** menu. See [“Deskset Settings” on page 172](#) for further instructions.
- Press **2** to display the **User Settings** menu. See [“User Settings” on page 176](#) for further instructions.
- Press **3** to display the **Admin Settings** menu. See [“Admin Settings” on page 193](#) for further instructions.
- Press **4** to display the **Deskset Information** menu. See [“Deskset Information” on page 194](#) for further instructions.
- **Call Appearance mode only** — If your system administrator has set your extension as an Auto Attendant Manager, the menu has an additional item. Press **5** to change the **Auto Attendant** settings. See [“Auto-Attendant Settings” on page 196](#) for further instructions.

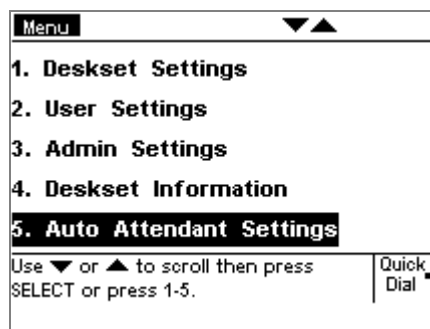

Deskset Settings

Use the **Deskset Settings** menu, as shown in Figure 51, to access the three functions and the related submenus listed in Table 23.

To display the Deskset Settings menu, press **MENU** then **1**.

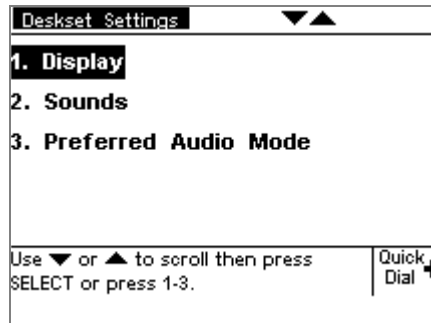

Figure 51. Deskset Settings Menu

Table 23. Deskset Settings Menu Structure

Function	See page...	Submenu
1. Display	173	1. Contrast (1–9) 2. Backlight (Lo/Hi/Off)
2. Sounds	173	1. Ring volume (0–9) 2. Audible Ring Delay (0–40 seconds) 3. Ringtones (1–9) 4. Key beeps (On/Off)
3. Preferred Audio Mode	175	1. Speakerphone 2. Headset



Display

Use the **Display** menu to adjust your Deskset LCD contrast and backlight.

To access the Display menu:

1. Press **MENU**, then **1**, and then **1**. The **Display** menu appears.

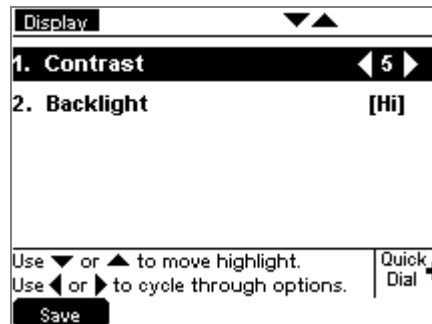

2. Press **1** to set the desired **Contrast** level.
Press ◀ or ▶ to adjust the level from 1 to 9. The default is 5.
3. Press **2** to set the desired **Backlight** level.
Press ◀ or ▶ to cycle through **Hi**, **Lo**, or **Off**. The default is **Hi**.
4. Press **Save** to accept the adjustments and return to the **Deskset Settings** menu.

Sounds

Use the **Sounds** menu to set the ring volume, delay the beginning of audible ringing, pick one of nine ringtones, or turn key beeps on and off.

To access the Sounds menu:

1. Press **MENU**, then **1**, and then **2**. The **Sounds** menu appears.

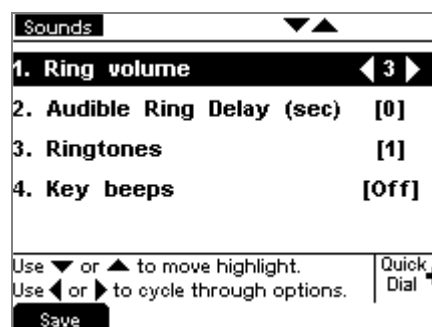

2. Press **1** on the dial pad to choose **Ring Volume**.
 - Press ◀ or ▶ to adjust the **Ring Volume** from 0 to 9. The default is 3. A ringer sample plays.
 - To turn off the ringer, decrease the volume to zero.



3. Press **2** on the dial pad to set the **Audible Ring Delay** from 0 to 40 seconds.
Press ◀ or ▶ to select one of the delay values. The default is **0**, which also disables the feature. Although the Call Appearance icon flashes, the Deskset does not ring for the time you set.
4. Press **3** on the dial pad to choose **Ringtones**.
Press ◀ or ▶ to select one of nine ringtones. The default is **1**. Ringtone samples play when selected.
5. Press **4** on the dial pad to choose **Key beeps**.
Press ◀ or ▶ to select **On** or **Off**. The default is **On**.
6. Press **Save** to accept the adjustments and return to the **Deskset Settings** menu.



Preferred Audio

When you press a Call Appearance or Line Appearance key or **Answer**, the call is answered in the **Preferred Audio** mode. You can set the audio preferences to **Headset** or **Speakerphone** by using the **Preferred Audio** menu. Lifting the corded handset takes first priority in all instances.

To access the Preferred Audio menu:

1. Press **MENU**, then **1**, and then **3**. The **Preferred Audio** menu appears.



2. Select the preferred audio:
 - Press **1** to select the **Speakerphone**.
 - Press **2** to select the **Headset**.
3. Press **Set?** to set your audio preference.
4. Press **Save** to accept the adjustments and return to the Deskset Settings menu.



User Settings

Use the **User Settings** menu to modify the settings shown in Figure 52 and listed in Table 24. User Settings vary depending on whether your system is in Call Appearance or Line Appearance mode.

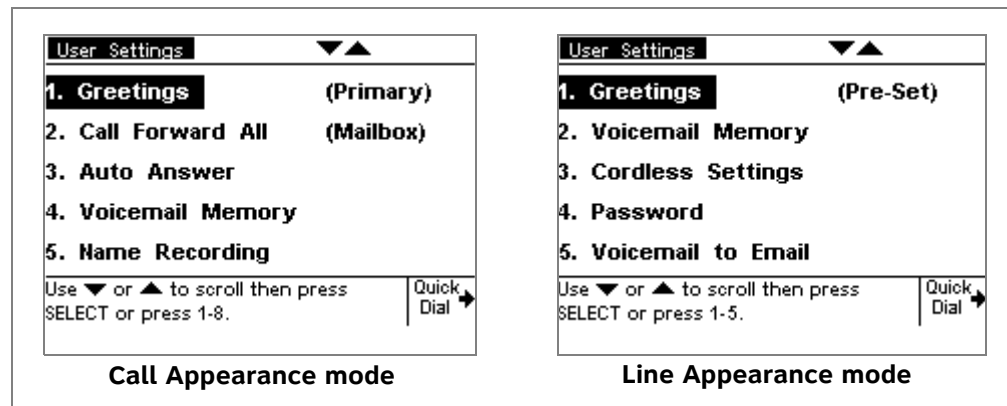

Figure 52. User Settings Menu

Table 24. Deskset Menu – User Settings

Call Appearance mode	See page...	Line Appearance mode	See page...
1. Greetings	177	1. Greetings	177
2. Call Forward All	179	2. Voicemail Memory	182
3. Auto Answer	181	3. Cordless Settings	185
4. Voicemail Memory	182	4. Password	191
5. Name Recording	183	5. Voicemail to Email	192
6. Cordless Settings	185		
7. Password	191		
8. Voicemail to Email	192		



To display the User Settings menu:

1. Press **MENU** and then **2**. The **User Settings** menu appears.
2. If you have set a user password, the **User Password** screen appears before the **User Settings** menu appears.

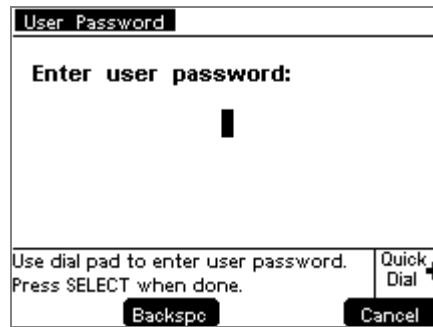

- Enter your password and press **SELECT**.
- To correct errors, use the **Backspc** key.
- To cancel your changes on that screen, press **Cancel** at any time. The Deskset will return to the previous screen.

Greetings

You can have three different greetings for your Voicemail. You can then choose the one that is currently appropriate. You can record a **Primary Greeting** to use most of the time and an **Alternate Greeting** for when you are out of the office. The **Pre-Set Greeting**, "Please leave a message after the tone," is used when no other greeting is recorded.

To select the current greeting:

1. Press **MENU**, then **2**, and then **1** to display the **Message Greetings** menu.

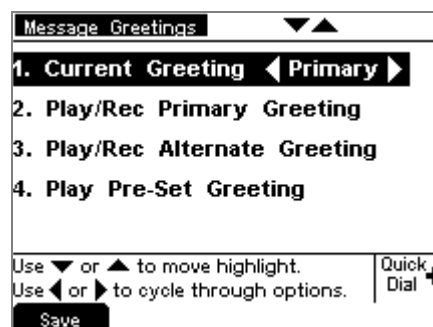

- Press **<** or **>** to select the **Pre-Set**, **Primary**, or **Alternate** greeting to be played to outside callers.
- To record a new **Primary** or **Alternate** greeting, see ["Recording a Greeting" on page 179](#).



**NOTE**

You cannot delete or record over the Pre-Set greeting.

2. Press **Save** to save the greeting. The system checks to see if the selected greeting has been recorded.
 - If the greeting has been recorded, the **User Settings** menu appears.
 - If a greeting has not been recorded, the **Greeting not recorded** screen appears and the **Pre-Set Greeting** is used. The **User Settings** menu appears.

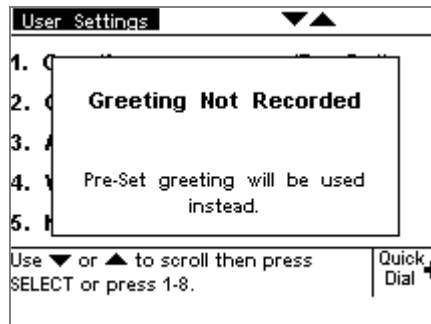

Recording a Greeting

You can record a greeting up to 60 seconds long. The procedure for recording a **Primary** or **Alternate Greeting** is the same.

To record either a Primary or Alternate greeting:

1. Press **MENU**, then **2**, and then **1** to display the Message Greetings menu.
2. Press either **2 (Primary)** or **3 (Alternate)** to select the greeting.
If you wish to record the greeting on the corded handset, lift the handset.
3. To record your greeting, press **Record**. The recording screen appears.

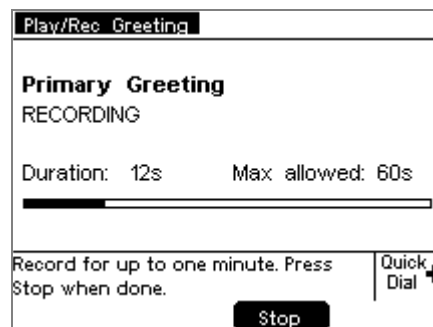

4. Press **Stop** when you are finished. The message review screen appears.

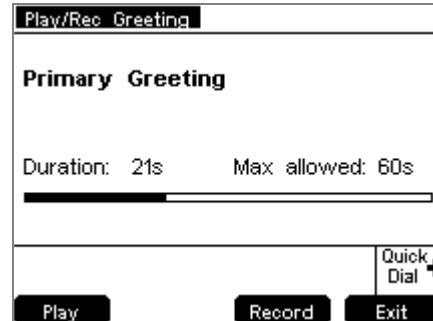

5. Press **Play** to review the message.
6. Press **Exit** to return to the **Message Greetings** menu.

Call Forward All and Call Forward–No Answer

Call Forward All and Call Forward–No Answer redirect incoming calls. Once your Deskset forwards a call, you cannot answer the call.

- **Call Appearance mode only** — You can set **Call Forward All** to redirect calls to a phone number, extension, or Voicemail. Your Deskset does not ring, but a message screen appears to confirm that the call was forwarded. Your Deskset does not record the call in its Call Log. Your company's caller ID is attached to calls that Call Forward All sends to outside numbers. The default destination is Voicemail.



To turn Call Forward All on or off, press **CallFwd** when the Deskset is idle. When activated, **FWD ON** appears in the upper right corner of the display. Call Forward All overrides the Call Forward–No Answer setting set by your system administrator.

You can set the Call Forward All destination in the **User Settings** menu or using the WebUI. See [“Basic Settings” on page 206](#).

- **Call Forward–No Answer** can only be set by the system administrator. This setting determines the delay of, and the destination for, unanswered calls for each extension. The default destination is Voicemail.

Call Appearance mode only — The Call Forward–No Answer setting does not apply to Ring Group calls or to incoming calls at extensions that are part of a Call Queue. See [“Answering Calls in the Call Queue” on page 65](#).

To set the Call Forward destination:

1. Press **MENU**, then **2**, and then **2**. The **Call Forward All** menu appears.

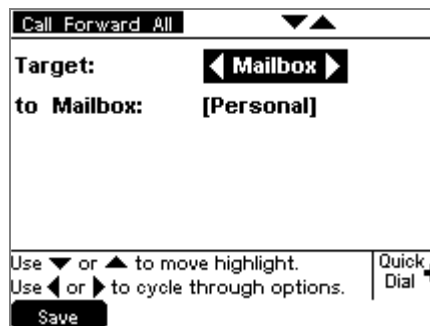

2. Press ◀ or ▶ to select one of the following targets:
 - **Mailbox**. Then press ▼ to move to the **to Mailbox:** field and select your personal mailbox or a Group Mailbox (if enabled).
 - **Ext.** Then press ▼ to move to the **to Ext:** field and enter a valid extension number.
 - **Phone #.** Then press ▼ to move to the **to Phone #:** field and enter a valid phone number. Enter a preceding 9 or whatever digit, if any, that must be dialed for outside calls.
3. To confirm the change, press **Save**. The **User Settings** menu appears. An error message appears if:
 - you entered an invalid extension number
 - your system administrator has disabled call forwarding/transferring to an outside line
 - you enter a restricted number.



Automatic Answering

 Auto Answer settings apply to Call Appearance mode only.

You can set the Deskset to automatically answer calls after a delay that you specify. Without touching the Deskset, you can speak to and be heard by people who call you. For example, employees in warehouses or shops may use this feature for quick conversations without having to interrupt what they are doing.

 DND and **Call Forward All** take priority over Auto Answer. If you have enabled **Call Forward All**, calls are forwarded before they can be Auto Answered. However, Auto Answer takes priority over the Call Forward-No Answer setting. See [“Call Forward All and Call Forward–No Answer” on page 179](#).

Auto Answer does not apply to Ring Group calls. See [“Incoming Call Indication” on page 58](#).

To set Auto Answer:

1. Press **MENU**, then **2**, and then **3**. The **Auto Answer** screen appears.

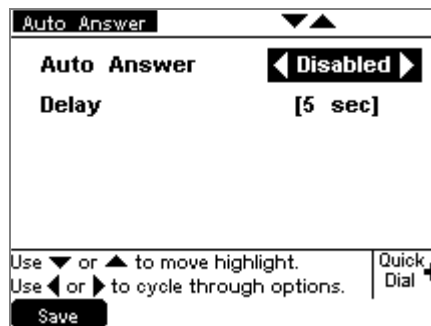

2. Press ◀ or ▶ to select either **Disabled** or **Enabled**.
3. Press ▼, then ◀ or ▶ to select the delay before the Deskset automatically answers each call.

 The Auto Answer Delay overrides the Call Forward–No Answer delay. See [“Call Forward All and Call Forward–No Answer” on page 179](#).

4. Press **Save** to confirm the change. The **User Settings** menu appears.



Voicemail Memory

Your Voicemail messages are stored on your Deskset. You can check the amount of available memory.

To access the Voicemail Memory screen:

1. **Call Appearance mode** — Press **MENU**, then **2**, and then **4**.

Line Appearance mode — Press **MENU**, then **2**, and then **2**.

The **Voicemail Memory** status screen appears.

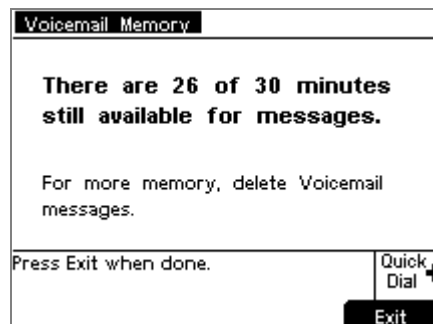

The **Voicemail Memory** screen displays the remaining minutes left for recording a message in Voicemail. This screen is for informational purposes only.

2. Press **Exit**. The **User Settings** menu appears.



NOTE

Even when this screen says **...0 of 30 minutes still available...**, there may still be enough time to record a short message and the **VM Full** status message may not appear. See ["Deskset Status Indicators" on page 18](#).



Name Recording

 Name Recording applies to Call Appearance mode only.
NOTE

If callers access the Company Directory when the Auto Attendant is on, they hear this recording upon entering your name.

To create a useful recording for incoming callers, you should say your name slowly, clearly, and at a reasonable volume. Your system administrator may also recommend that you state both your name and extension number. It is important that your recording be consistent with recordings at other extensions in the system.

To record and play a personal name:

1. Press **MENU**, then **2**, and then **5**. The **Name Recording** menu appears.

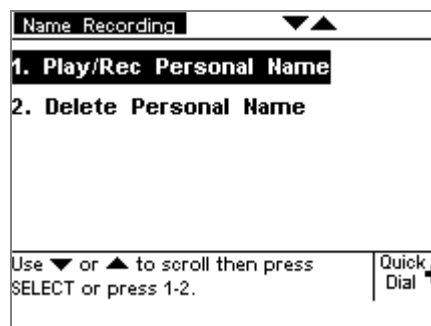

2. Press **1** to display the **Play/Rec Name** screen.

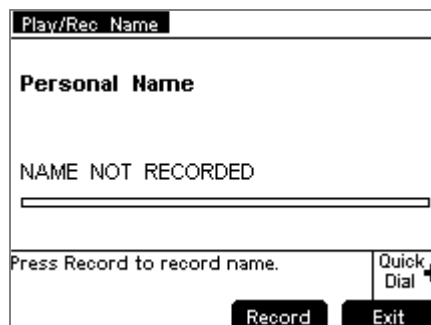

3. Press **Record** to record a personal name.

 You are limited to a 10-second recording; recording stops automatically if the limit is exceeded.
NOTE

4. When you are finished recording, press **Stop**. The screen changes to display **Play** and **Record**.



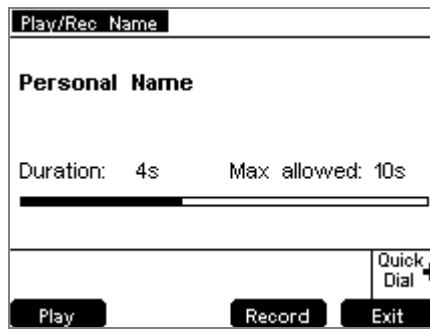

5. Press **Play** to review the recorded name.
6. Press **Exit**. The **Name Recording** menu appears.

To delete a personal name:

1. Press **MENU**, then **2**, and then **5**. The **Name Recording** menu appears.
2. Press **2** to delete the personal name. A confirmation screen appears.

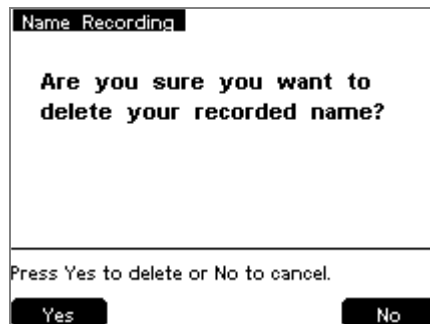

3. Press **Yes** to confirm.

After you delete your recorded name, the Auto Attendant will announce your extension number instead.



Registering an Optional Cordless Handset



The Cordless Handset is not supported in Line Appearance mode.

NOTE

You can register only one AT&T SB67040 Cordless Handset and only one AT&T TL7600 Cordless Headset to a Deskset. When a Deskset has cordless accessories, they are all part of the same extension, and only one device can be used at a time.

To register the SB67040 Cordless Handset:

1. Press **MENU**, then **2**, and then **6**. The **Cordless Settings** menu appears.

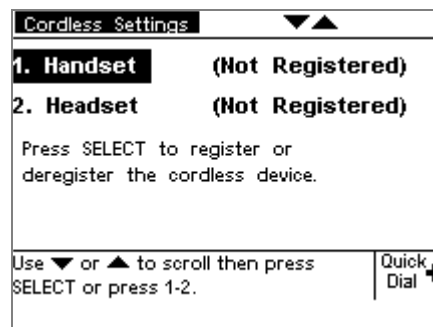

2. Press **1** to display the **Cordless Handset Registration** screen.



3. Prepare the Cordless Handset to be registered. The Handset must be in the charger with the **REGISTER** screen displayed.

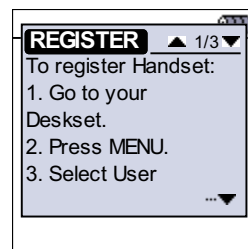

4. Even if the Cordless Handset has been in its charger, remove and replace the Cordless Handset before you press **Register** on the Deskset.



**NOTE**

It does not matter which device starts the registration process.

5. Press **Register** on the Deskset. **Registration in Progress...** appears while the Deskset searches for the Handset. Once found, the **Registration in progress...** screen appears on the Cordless Handset.

When registration is complete, **Cordless Handset is currently Registered** appears on the Deskset and the **Handset Registered** screen appears on the Cordless Handset.

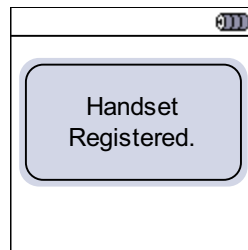

6. Press **Exit** on the Deskset. The **Cordless Settings** menu appears.

**NOTE**

Registration can be terminated by pressing **CANCEL** on the Deskset. If the Cordless Handset is registered to another Deskset, it must be deregistered first.

Registering an Optional Cordless Headset

You can register only one AT&T SB67040 Cordless Handset and only one AT&T TL7600 Cordless Headset to a Deskset. When a Deskset has cordless accessories, they are all part of the same extension, and only one device can be used at a time.

To register the TL7600 Cordless Headset:

1. **Call Appearance mode** — Press **MENU**, then **2**, and then **6**.
Line Appearance mode — Press **MENU**, then **2**, and then **3**.

The **Cordless Settings** menu appears.

**NOTE**

The Headset must be in the charger, otherwise registration cannot proceed. Even if the Cordless Headset has been in its charger, remove and replace the Cordless Headset before you press **Register** on the Deskset.

2. Press **2** to display the Cordless Headset Registration screen.



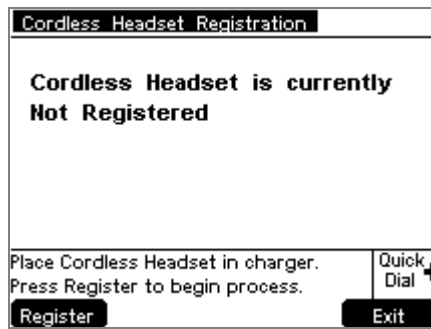

3. Press **Register** . **Registration in Progress...** appears while the Deskset searches for the Headset.
4. When registration is complete, **Cordless Headset is currently Registered** appears and the Cordless Headset **ON/OFF** light turns solid blue.
5. Press **Exit** . The Cordless Settings menu appears.

**NOTE**

Registration can be terminated by pressing **CANCEL** on the Deskset.

If the Cordless Handset is registered to another Deskset, it must be deregistered first. See ["Deregistering a Cordless Handset or Headset" on page 187.](#)

Deregistering a Cordless Handset or Headset

You must deregister cordless accessories before you can register them to different Desksets. If you remove a Deskset from the system, first deregister any cordless accessories.

To deregister a cordless accessory:

1. **Call Appearance mode** — Press **MENU**, then **2**, and then **6**.
Line Appearance mode — Press **MENU**, then **2**, and then **3**.

The **Cordless Settings** menu appears.

The following procedure describes deregistering the Cordless Handset. The process is identical for the Cordless Headset, except in Step 2, you press **2**, rather than **1** to deregister the Cordless Headset.

2. Press **1** to display the **Cordless Handset Registration** menu.

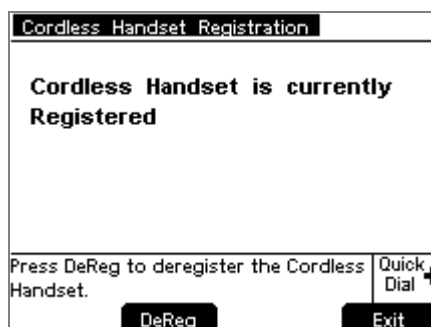

3. Press **DeReg** . The confirmation message appears.
4. Press **Yes** to confirm deregistration.

The Deskset screen then displays **Cordless Handset is currently Not Registered**.



The REGISTER screen appears on the Cordless Handset. (The Cordless Headset **ON/OFF** light slowly flashes.)

5. Press **Exit** . The **Cordless Settings** menu appears.



Deregistering the Cordless Handset or Headset without the Deskset

Cordless Handsets or Headsets can also be deregistered using the Handset or Headset. You can use this method when you cannot use the Deskset for standard deregistration. The Deskset may be out of range or may have been removed from the system.

To deregister the Handset when the Deskset is not available:

1. At the Cordless Handset, press **OPTIONS** and then **5**. The **Settings** screen appears.

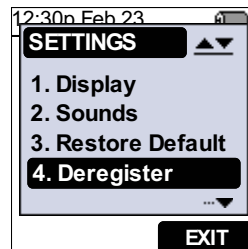

2. Press **4** for **Deregister**. The Deregister Confirmation screen appears.

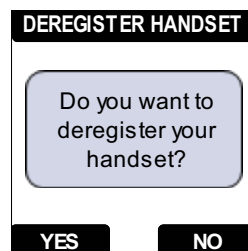

3. Press **YES**.



If you deregister a Cordless Handset using the Handset, the previously registered Deskset does not recognize the deregistration. You must also deregister the Cordless Handset from that Deskset before another Cordless Handset can be registered to that Deskset.

To deregister the Cordless Headset when the Deskset is not available:

1. On the Headset, press **VOL+ -> MUTE -> VOL- -> MUTE -> VOL+ -> VOL- -> MUTE**.



Cordless Accessory Registration and Deregistration Time-Out



If the cordless device is registered to another Deskset or telephone, it must be deregistered first. See [“Deregistering a Cordless Handset or Headset” on page 187](#).

For security reasons, the registration process on both Deskset and cordless accessory terminates after the time-out period of two minutes if registration is not successful.

If the registration process times out on the cordless accessory, the cordless accessory resets itself. The Deskset returns to the unregistered cordless accessory startup screen.

The Handset displays **Registration Failed** if the process times out.

If the registration process times out on the Deskset, it displays **Registration Failed** and returns to Idle mode.

If Cordless Headset registration fails, the **ON/OFF** light on the Headset flashes twice every five seconds. To reset the Headset, remove the Headset from the charger and try the registration process again, beginning with Step 1, [“To register the TL7600 Cordless Headset:” on page 186](#).



Setting and Changing Your Password

Use the **Password** menu to set, change, or clear your password. This setting can also be controlled on the WebUI.

Once the password has been cleared, password entry is no longer necessary for User Settings, Voicemail and the WebUI.

To set, change or clear your password:

1. **Call Appearance mode** — Press **MENU**, then **2**, and then **7**.
Line Appearance mode — Press **MENU**, then **2**, and then **4**.

The **Password** menu appears.

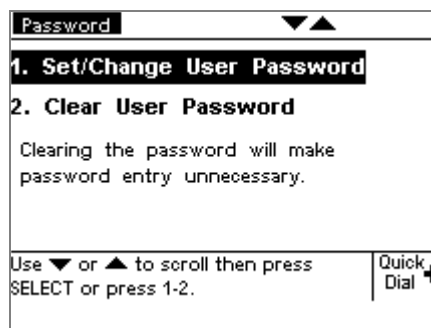

2. To set or change your password, press **1**.
 - Use the dial pad to enter a password of up to six digits.
 - To correct errors, press **Backspc**, or to start over, press **Delete**.
 - Press **▽** and enter the new password again.

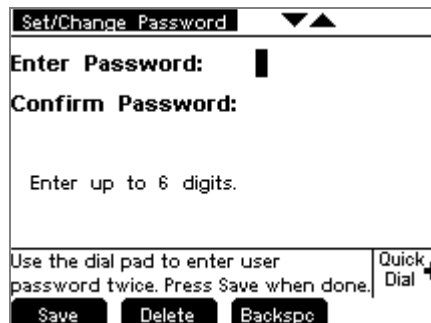

- To accept the change, press **Save**. The **Password Saved** screen appears, then the **User Settings** menu appears.
3. To clear your password, press **2**.
 - Press **Yes** to confirm that you want to clear your password. The **Password** menu appears.



Setting the Voicemail to Email Mode

The Voicemail to Email feature converts new voicemail messages to .WAV files and sends them to your email account as an attachment. You can also choose to receive an email notification of a new message without the .WAV attachment.

1. **Call Appearance mode** — Press **MENU**, then **2**, and then **8**.

Line Appearance mode — Press **MENU**, then **2**, and then **5**.

The **Voicemail to Email** menu appears.



The **Voicemail to Email** menu is available only if this feature has been enabled for your Deskset.

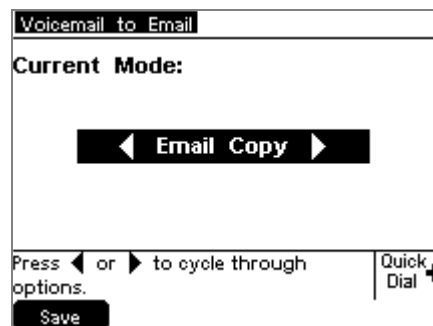

2. Press \triangleleft or \triangleright to select the desired Voicemail to Email mode:
 - **OFF**
 - **Email Copy:** Voicemail messages will be emailed to you as audio file attachments.
 - **Email Notification:** You will receive email notifying you of new Voicemail messages.
3. Press **Save** . The **User Settings** menu appears.



Admin Settings



The Admin Settings are determined by your system administrator. Only someone with access to the system administrator's password can change the Admin Settings.

To display the Admin Settings menu:

1. Press **MENU**, then **3**. You then must enter the Admin password before you can view the Admin Settings menu.

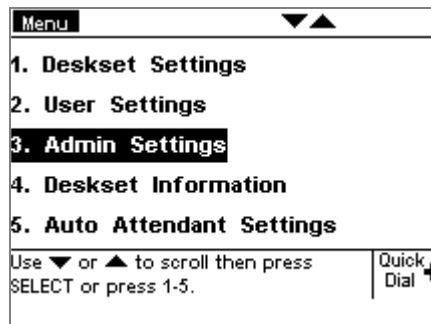

For more information on these settings, see the Synapse Administrator's Guide, available for download at www.telephones.att.com/synapseguides.



Deskset Information

Use the **Deskset Information** screen, shown in Figure 53, to find the Deskset's IP Address, which you will need to access the WebUI. The other Deskset information may be used by your system administrator or the installer.

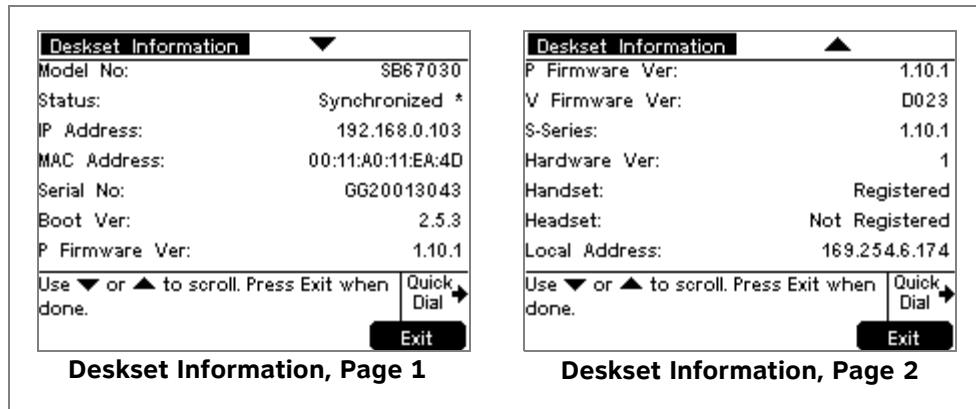

Figure 53. Deskset Information

To display Deskset Information:

1. Press **MENU** and then **4**. The **Deskset Information** screen appears.

The model number, device status, IP Address, and Firmware number are listed with other information.

2. Press **▼** to view additional information.
3. Press **Exit** to return to the Main menu.



Using Do Not Disturb (DND)

Do Not Disturb (DND) silences incoming ringing and paging. You can still answer incoming calls when DND is on. The incoming call screen appears and the Call Appearance or Line Appearance LED flashes.

To enable or disable Do Not Disturb:

1. From the Idle screen, press **DND** . If necessary, press **More 2/2** to display **DND** .
DND ON appears in the top right of the Idle screen.



2. Press **DND** to turn DND off. **DND ON** disappears from the screen.



Call Appearance mode — The DND indicator only appears when Call Forward All is disabled. When Call Forward All is set, no calls ring regardless of the DND setting, so the DND indicator does not appear.



Auto-Attendant Settings



Auto Attendant Settings apply to Call Appearance mode only.

If your system administrator has set your extension as an Auto Attendant Manager, you can use the Deskset to manage one or more Auto Attendants.

To manage the Auto Attendant Settings:

1. Press **MENU** to display the **Menu** with a fifth item, **Auto Attendant Settings**.

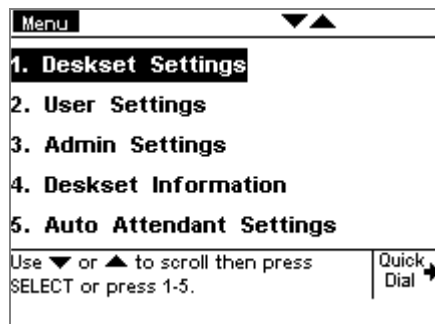

2. Press **5** to display the **Auto-Attendant Settings**. The screen displays a list of Auto Attendants that you can manage.

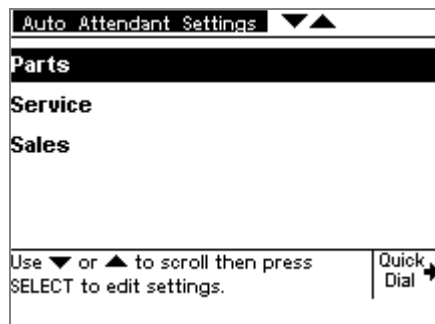

3. Highlight the name of the Auto Attendant you want to manage and press **SELECT**.
4. Press **◀** or **▶** to select **Scheduled**, **OFF**, or **Manual**.

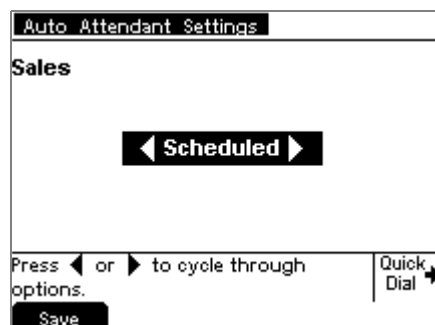

- **Scheduled:** Turns the selected Auto Attendant on. Incoming calls are forwarded to an Auto Attendant menu or destination according to the weekly schedule that the system administrator has set.
 - **OFF:** Turns the Auto Attendant off. Incoming calls are forwarded to the destination that the system administrator has set.
 - **Manual:** Immediately forwards incoming calls to the Auto Attendant menu that the system administrator has set. No weekly schedule applies.
5. Press **Save** to save the setting. The list of Auto Attendants appears.



Cordless Handset Settings



The Cordless Handset is not supported in Line Appearance mode.

Once the optional Cordless Handset has been registered to the Deskset, you can set up the Cordless Handset:

- ["Setting Cordless Handset Contrast" on page 199](#)
- ["Setting the Cordless Handset Sounds" on page 199](#)
- ["Setting the Cordless Handset Ringer and Voice Volume" on page 200](#)
- ["Setting the Cordless Handset to Factory Default" on page 201](#)
- ["Viewing the Cordless Handset Product ID" on page 201.](#)



Setting Cordless Handset Contrast

To adjust the display contrast:

1. Press **OPTIONS**, then **5** to display the Settings menu.
2. Press **1**. The **Contrast** screen appears.

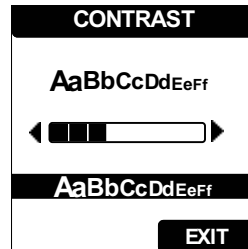

3. Press \triangleleft or \triangleright to adjust the contrast until the desired level is reached.
4. To accept the changes you have made and return to the Settings menu, press **EXIT**.

Setting the Cordless Handset Sounds

To adjust the sound:

1. Press **OPTIONS**, then **5** to display the Settings menu.
2. Press **2**. The **Sounds** menu appears.

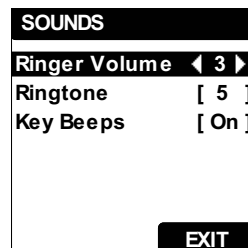

3. Press \triangle or ∇ to select audio options:
 - To adjust the ringer volume from 0 to 6, press \triangleleft or \triangleright . Decreasing the volume to zero silences the ringer. The ringer sounds as it is adjusted. You can also change the ringer volume in the Idle mode by pressing the Handset volume control, \triangleleft **VOLUME** \triangleright .
 - To choose one of nine ringtones, press ∇ once to highlight **Ringtone**. To select the ringtone, press \triangleleft or \triangleright . This setting only applies to the Cordless Handset.
 - To turn Key Beeps on or off, press ∇ twice to highlight **Key Beeps**. Press \triangleleft or \triangleright to turn the Key Beeps **On** or **Off**.
4. To accept the adjustments and return to the **Settings** menu, press **EXIT**.



Setting the Cordless Handset Ringer and Voice Volume

The Handset also provides a volume control on the right side of the handset. You can increase or decrease the ringer volume only when not on an active call. You can increase or decrease the incoming voice volume during an active call or during message playback.

To adjust the ringer volume:

When not on an active call, press ◀ **VOLUME** ▶ to increase or decrease the ringer volume.

A **Ringer** screen appears. The example shows the volume set to 3. The minimum ringer volume is zero (silenced) and the maximum volume is 6.

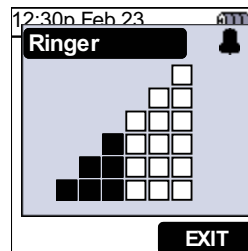

If you set the ringer to zero (silenced), the silent ring icon (see [“Cordless Handset Screen Icons” on page 31](#)) appears during an incoming call.

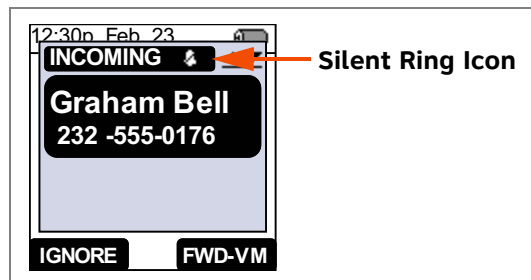

To adjust the incoming voice volume:

During an active call or during message playback, press ◀ **VOLUME** ▶ to increase the incoming voice volume.

A **PHONE** screen appears. The example shows the volume set to 3. There are six volume levels.

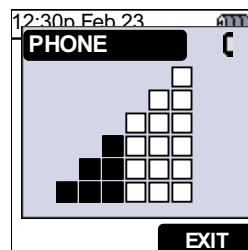

If you are using the speakerphone, the speakerphone volume is adjusted.



Setting the Cordless Handset to Factory Default

To reset the Handset to default settings (factory defaults):

1. Press **OPTIONS**, then **5** to display the **Settings** menu.
2. Press **3**. The **RESTORE DEFAULT** screen appears.

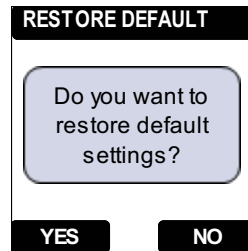

- Press **YES** to clear all Handset custom settings.
- Press **NO** to keep current settings.

Viewing the Cordless Handset Product ID

To view the Product ID:

1. Press **OPTIONS**, then **5** to display the **Settings** menu.
2. Press **5**. The **PRODUCT ID** screen appears.



This page displays the Handset's identification information, including serial number, model number, software version, and registration status. This information cannot be altered.

3. Press **EXIT** to return to the **Settings** menu.



CHAPTER
11

WEB INTERFACE

Use an Internet browser to access the Web User Interface (WebUI) that resides on the Deskset. See [“Accessing the Web User Interface \(WebUI\)” on page 203](#). After you log in to the WebUI, you can configure the following features:

- [“Basic Settings” on page 206](#)
- [“Extension Directory” on page 208](#)
- [“Quick-Dial Keys” on page 210](#)
- [“Voicemail Distribution” on page 211](#).

You can also view the Deskset Help from the WebUI. See [“Help” on page 214](#).



Accessing the Web User Interface (WebUI)

To access the WebUI:

1. Ensure that your computer is connected to the same network as the Synapse system. In most cases, your computer will already be connected to the network through the PC port on the back of a Deskset.
2. On the Deskset, press **MENU** then **4** to display **Deskset Information**.
3. On the **Deskset Information** screen, find the IP Address.

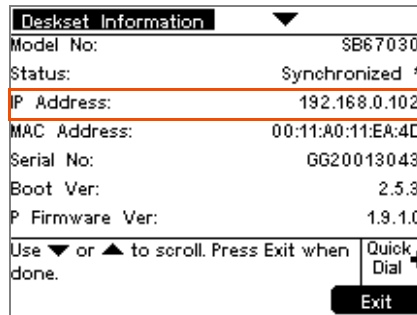

4. On your computer, open an Internet browser. AT&T recommends Internet Explorer (7 or higher).
5. Type the Deskset IP address in the browser address bar, and press **ENTER** on your computer keyboard.

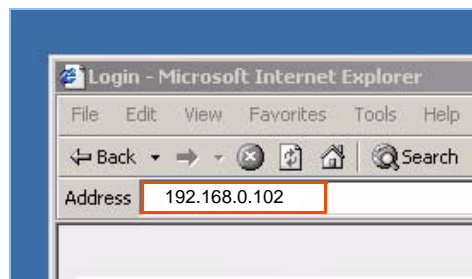

6. A **Login** page appears.

Login

Login Name:

Login Name: Users should enter the extension number. Administrators should enter the Administrator ID.

Password:

Password: If there is an Extension password, the User should enter that password. If there is no Extension password, the User should leave the password field blank. Administrators should enter the administrator password.

7. Under **Login Name**, log in as a user by typing your extension number.



8. Enter your password if you have created one (see [“Setting and Changing Your Password” on page 191](#)). Otherwise, leave the password blank.
9. Click .
 - You can create or change your user password once you are logged in.
 - The **Basic Settings** page shown in [Figure 55 on page 206](#) appears.

 **CAUTION** *Changing a setting does not instantly apply the new value. Clicking saves and applies all changes on that page.*



Error Handling

If you type an invalid value into one of the WebUI fields and click **Apply**, the page is not saved. The WebUI displays an error message at the top of the page. The field with the incorrect value is highlighted in yellow, as shown in Figure 54. You can view a more detailed error description by resting your mouse pointer on the highlighted field.

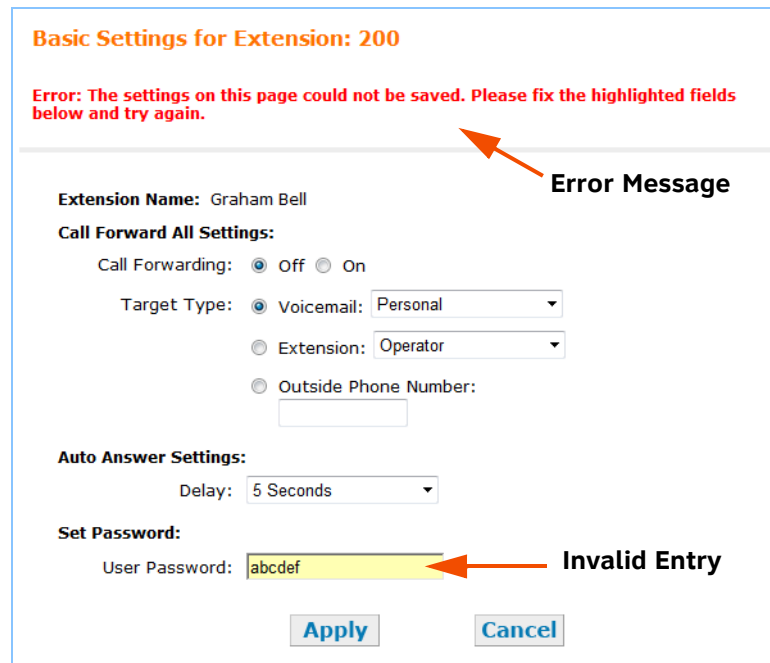

The screenshot displays the 'Basic Settings for Extension: 200' page. At the top, a red error message reads: 'Error: The settings on this page could not be saved. Please fix the highlighted fields below and try again.' Below this, the settings are organized into sections: 'Extension Name: Graham Bell', 'Call Forward All Settings' (with radio buttons for 'Off' and 'On', and dropdowns for 'Target Type' set to 'Voicemail', 'Personal', 'Extension', and 'Operator'), and 'Auto Answer Settings' (with a 'Delay' dropdown set to '5 Seconds'). The 'Set Password' section shows a 'User Password' field containing 'abcdef', which is highlighted in yellow. An orange arrow points from the text 'Invalid Entry' to this field. Another orange arrow points from the text 'Error Message' to the red error message at the top. At the bottom of the form are 'Apply' and 'Cancel' buttons.

Figure 54. WebUI Error Indication



Basic Settings

The remaining procedures in this chapter assume that you are already logged in to the WebUI. See [“Accessing the Web User Interface \(WebUI\)” on page 203](#).

After logging in, the **Basic Settings** page appears as shown in Figure 55. Your **Extension Name**, which the system administrator enters, is displayed on internal calls. In Call Appearance mode, callers using the Auto Attendant can search for your Extension Name to reach your extension.

Basic Settings for Extension: 200

Extension Name: Graham Bell

Call Forward All Settings:

Call Forwarding: Off On

Target Type: Voicemail:
 Extension:
 Outside Phone Number:

Auto Answer Settings:

Delay:

Voicemail to Email Settings:

Enable: Yes No

Email Address:

Auto Delete: Off On

Current Mode: Email copy (audio attachment)
 Email notification (no attachment)
 Off

Set Password:

User Password:

**Figure 55. WebUI Basic Settings
(Call Appearance mode shown)**



In Line Appearance mode, only the **Set Password** setting is available.

NOTE

To modify the Basic Settings:

1. Set the **Call Forward All Settings**. When on, Call Forward All forwards calls to the target you select, and your Deskset does not ring.
 - a. Turn **Call Forwarding** Off or On.
 - b. Select the **Target Type**.
 - ▣ **Voicemail:** Select either **Personal** or, if your system has Group Mailboxes, one of the Group Mailboxes.



- **Extension:** Select an extension number or the Operator extension.
 - **Outside Phone Number:** Enter an outside telephone number. Enter a preceding **9** or whatever digit, if any, that you would dial for an outside call. For example, enter your cell phone number as the Outside Phone Number to have all calls forwarded to your cell phone. This option does not appear if your system administrator has disabled call forwarding/transferring to an outside line. An error message appears after you click **Apply** if you enter a restricted number.
2. Under **Auto Answer Settings**, select an Auto Answer delay. The Auto Answer feature automatically answers calls after the delay time you select. Turn Auto Answer on or off from the Deskset menus. See ["Auto Answering" on page 41](#).
 3. Configure the **Voicemail to Email Settings**:
 - a. Click **Yes** or **No** to enable or disable Voicemail to Email for this extension.
 - b. Enter your Email Address. Audio files and notifications will be sent to this address.
 - c. Click **Off** or **On** to disable or enable Auto Delete. When on, messages are automatically deleted from your personal mailbox once they are sent to email as audio files. This setting does not apply to Group Mailboxes.
 - d. Select the **Current Mode** for Voicemail to Email.
 - Email copy (audio attachment)
 - Email notification (no attachment)
 - Off.
 4. Under **User Password**, create or change your Deskset password. The password must consist of up to 6 digits.
 5. Click **Apply** to save your changes.



Extension Directory

To allow easy dialing, you can create a personal **Extension Directory** (referred to as the **Personal** list on the Deskset) that is only available from your extension. Your administrator can also create a System Directory of names and phone numbers (referred to as **System** list on the Deskset) that is available to all extensions.

To add an entry to the Extension Directory:

1. In the navigation menu at left, click **Extension Directory**. The **Directory List** page appears.

2. Click **Add New Entry**. The **Add Extension Directory List Entry** page appears.

3. Complete the form with the desired information.
4. Click **Apply** to save. The Directory List appears with the entries added.

<input type="checkbox"/>	ABC Accountants	9-1-503-555-0194	[Edit]
<input type="checkbox"/>	Angela Martin	9-1-732-555-7318	[Edit]
<input type="checkbox"/>	Davis Carterer	9-1-317-555-0129	[Edit]
<input type="checkbox"/>	Graham Bell	9-1-232-555-0176	[Edit]
<input type="checkbox"/>	Mary Williams	9-1-888-722-7702	[Edit]



To edit Extension Directory entries:

1. In the navigation menu at left, click **Extension Directory**. The **Directory List** page appears.

Directory List for Extension: 201

[Add New Entry](#)

[Delete Selected Entries](#) [Sort By Last Name](#)

<input type="checkbox"/>	ABC Accountants	9-1-503-555-0194	[Edit]
<input type="checkbox"/>	Angela Martin	9-1-732-555-7318	[Edit]
<input type="checkbox"/>	Davis Carterer	9-1-317-555-0129	[Edit]
<input type="checkbox"/>	Graham Bell	9-1-232-555-0176	[Edit]
<input type="checkbox"/>	Mary Williams	9-1-888-722-7702	[Edit]

2. Click **[Edit]** next to the entry to be edited. The **Edit Extension Directory List Entry** page appears.

Edit Extension Directory List Entry

First Name:

Last Name:

Phone Number:

For outside phone numbers, enter a Trunk Prefix first (if your system uses a Trunk Prefix).

[Apply](#) [Cancel](#)

3. Complete the form with the desired information.
4. Click [Apply](#) to accept your changes or [Cancel](#) to reject the changes.

To sort and delete Extension Directory entries:

1. In the navigation menu at left, click **Extension Directory** to display the Directory List.
2. To sort entries by last name, click [Sort By Last Name](#). The button changes to [Sort By First Name](#). This action only works during the current session. The sort order reverts to listing the names by first name when you log in the next time.
3. To delete Directory entries:
 - a. Click the check boxes for the entries you want to delete.
 - b. Click [Delete Selected Entries](#). All of the selected entries are removed.



Quick-Dial Keys

To add or edit Quick-Dial entries:

1. In the navigation menu at left, click **Quick Dial Keys**. The **Quick Dial Keys** page appears.

Quick Dial Keys for Extension: 201

For outside phone numbers, enter a Trunk Prefix first (if your system uses a Trunk Prefix).

Name	Number	
<input style="width: 80%;" type="text" value="Charlie Johnson"/>	<input style="width: 80%;" type="text" value="91888832445"/>	→
<input style="width: 80%;" type="text" value="Mary Williams"/>	<input style="width: 80%;" type="text" value="918887227702"/>	→
<input style="width: 80%;" type="text" value="Richard"/>	<input style="width: 80%;" type="text" value="91305550134"/>	→
<input style="width: 80%;" type="text" value="Linda"/>	<input style="width: 80%;" type="text" value="91732557318"/>	→
<input style="width: 80%;" type="text"/>	<input style="width: 80%;" type="text"/>	→
<input style="width: 80%;" type="text"/>	<input style="width: 80%;" type="text"/>	→

2. Enter names and telephone numbers or extensions in the **Name** and **Number** columns. If it is an outside phone number, enter a **9**, or whatever digit, if any, that must be dialed first to indicate this is an outside call.
To edit or delete an entry, type over the entry.
3. To save the entries, click , or to reject the changes, click .
4. Press the key to the right of the **Quick Dial** → label on the Deskset to verify that the entries have been added or edited.

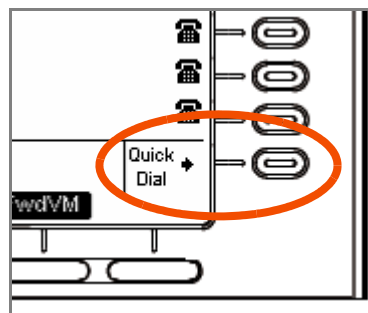

Call Appearance mode only — If your system administrator has set up your phone to access the Call Queue, the Quick Dial key is replaced by the Call Queue key. See [“Answering Calls in the Call Queue” on page 65](#). Quick Dial keys will not be available on your Deskset unless the system administrator enables the Quick Dial key again.



Voicemail Distribution

If you enable Voicemail Distribution, you can leave new messages or forward existing messages to lists that you create in the WebUI. This feature is disabled by default. If you enable this feature, there will be an additional step every time you press **MESSAGES** to access your Voicemail. See ["Accessing Your Messages" on page 131](#).

To enable and disable Voicemail Distribution Lists:

1. In the navigation menu at left, click **Voicemail Distribution** to display the **Voicemail Distribution Lists** page.

If you have previously enabled Voicemail Distribution and created one or more Voicemail Distribution lists, the existing Voicemail Distribution Lists appear.

Voicemail Distribution Lists for Extension: 200

Voicemail Distribution is currently: Enabled

[Disable Voicemail Distribution](#)

Name	Members	
Product Development	7	View/Edit
Sales	5	View/Edit
Service	3	View/Edit
Warehouse	2	View/Edit

[Create New Distribution List](#)

2. Click [Enable Voicemail Distribution](#) to enable or [Disable Voicemail Distribution](#) to disable Voicemail Distribution.



To create a Voicemail Distribution List:

1. In the navigation menu at left, click **Voicemail Distribution** to display the **Voicemail Distribution Lists** page.
2. Click [Create New Distribution List](#). The **Create Distribution List** page appears.

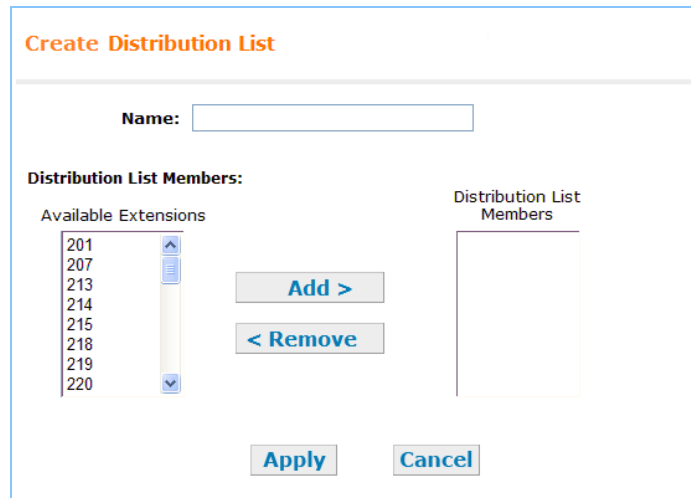

3. Enter a **Name** for the Voicemail Distribution List.
4. Assign **Distribution List Members**.
Select one or more extensions from the **Available Extensions** list and click [Add >](#).
OR
Select one or more extensions to remove from the **Distribution List Members** list and click [< Remove](#).
5. Click [Apply](#) to save these settings or click [Cancel](#) to return to the previous page without saving the changes.



To edit or delete a Voicemail Distribution List:

1. In the navigation menu at left, click **Voicemail Distribution** to display the **Voicemail Distribution Lists** page.
2. Click **View/Edit** for the Distribution List you want to edit or delete. The **Edit Distribution List** page appears.

Edit Distribution List

Name: Product Development

Distribution List Members:

Available Extensions		Distribution List Members
201	Add >	227
207	< Remove	229
213		235
214		240
215		241
218		243
219		244
220		

Apply **Cancel** **Delete Distribution List**

3. Optional: Click **Delete Distribution List** to delete this Distribution List, then go to Step 6.
4. Edit the Distribution List **Name** as needed.
5. Assign **Distribution List Members**.
Select one or more extensions from the **Available Extensions** list and click **Add >**.
OR
Select one or more extensions from the **Distribution List Members** list and click **< Remove**.
6. Click **Apply** to save these settings or click **Cancel** to return to the previous page without saving the changes.



Help

To access WebUI Help:

1. In the navigation menu at left, click **Help**.

A PDF Help file opens.

Help Menu

Online Resources

[Accessing Synapse Demo Videos](#)
[Accessing Synapse Product Documentation](#)

Extension Settings

[Setting the User Password](#)
[Configuring Call Forward All](#)
[Configuring Auto Answer](#)

Personal Directory

[Adding a New Personal Directory entry](#)
[Editing a Directory entry](#)
[Deleting Personal Directory entries](#)
[Sorting the Personal Directory list by First or Last Name](#)

Quick Dial

[Adding / Editing Quick Dial entries](#)

Voicemail Distribution

[Creating a Voicemail Distribution List](#)

2. To view a topic, click the link for that topic. The page for that topic appears.

Online Resources

Accessing Synapse Demo Videos

You can view Synapse demo videos at <http://telephones.att.com/smb>. In the left navigation menu, click on **Customer Support**, then **Demo Videos**.

Accessing Synapse Product Documentation

For additional information on these features, see the "Synapse Administrator's Guide" at <http://telephones.att.com/synapseguides>.



CHAPTER
12

TROUBLESHOOTING

If you have difficulty operating your Deskset and Accessories, try the following suggestions in this section:

- [“Common Troubleshooting Procedures” on page 216](#)
- [“Display Messages” on page 218](#)
- [“Calls Generally” on page 220](#)
- [“Incoming Calls” on page 224](#)
- [“Outgoing Calls” on page 226](#)
- [“Voicemail” on page 228](#)
- [“Other Deskset Features” on page 231](#)
- [“WebUI” on page 234](#)
- [“PC/Deskset Interaction” on page 235](#)
- [“SB67040 Cordless Handset” on page 236](#)
- [“TL7600 Cordless Headset” on page 242.](#)



For customer service or product information, contact the person who installed your system. If your installer is unavailable, visit our web site at www.telephones.att.com/smb or call **1 (888) 916-2007**. In Canada, dial **1 (888) 883-2474**.



Common Troubleshooting Procedures

Follow these procedures to resolve common issues.

Resolving General Functional Issues

To resolve a blank screen or device that does not work at all:

- Ensure the AC plug is plugged into an electrical outlet not powered by a wall switch.
- Verify that the AC power outlet has power. Try plugging in some other AC device. If nothing works, contact an electrician or use another power outlet.
- Verify that the DC plug is plugged into the power jack on the device.
- The system devices are not immediately active when powered up and after a power interruption. Allow at least 30 seconds for the device to boot up.
- If you have an SB67031 Deskset using Power over Ethernet (PoE), ask your system administrator to confirm that the PoE switch is working correctly.

To resolve a sluggish, unresponsive, or unusually behaving device:

Reset the device by pressing the **RESET** button on the back of the Deskset for less than five seconds or by removing and restoring AC power.

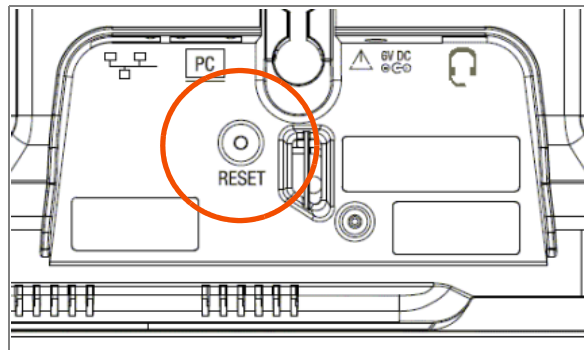

 **CAUTION** Pressing the **RESET** button for more than five seconds will erase all data and settings.

To restore a Deskset to factory defaults:

Insert a pen or paper clip into the Reset hole on the back of the Deskset and press the **RESET** button for more than five seconds.



To resolve problems with a cordless device:

For features or audio problems, make sure that the Deskset associated with the cordless device does not share the problem. If it does, look in Deskset Troubleshooting. See ["Other Deskset Features" on page 231](#).

1. Verify that the device battery has power.
 - When removed from the charger, the Cordless Handset screen is lit for about 30 seconds.
 - When removed from the charger, the Cordless Headset emits a dial tone or three beeps when you press **ON/OFF**.
 -  If there is no power, see the Handset or Headset installation sections of the Synapse Installation Guide at www.telephones.att.com/synapseguides
2. Verify that the Deskset **Cordless Settings** screen indicates that the device is registered.
 - Press **MENU** → **2** → **6**.
 - If the Handset is not registered, register it:
 - a. Place the Handset in the charger.
 - b. Register the Handset at the Deskset. Press **MENU** → **2** → **6** → **1** → **Register** .
 - If the Headset is not registered, register it:
 - a. Place the Headset in the charger.
 - b. Register the Headset at the Deskset. Press **MENU** → **2** → **6** → **2** → **Register** (Call Appearance mode), or **MENU** → **2** → **3** → **2** → **Register** (Line Appearance mode).



Display Messages

The screen is blank or the Deskset menu does not work.

Probable Cause	Corrective Action
There may be no power or the Deskset may need to be reset.	<ul style="list-style-type: none"> See "To resolve a blank screen or device that does not work at all:" on page 216. Reset the Deskset to factory defaults. Insert a pen or paper clip into the reset hole and press for more than five seconds.

The screen displays Joining Site... for more than one minute.

Probable Cause	Corrective Action
The Gateway is failing to synchronize with a Deskset configured for a different system configuration.	<ul style="list-style-type: none"> Always disconnect the LAN cable before restoring factory defaults (by pressing the RESET button more than five seconds).

The screen displays Network Down.

Probable Cause	Corrective Action
The Ethernet cable is unplugged.	<ul style="list-style-type: none"> Ensure that one end of the Ethernet cable is plugged into the port marked LAN on the device and that the other end is plugged into your office LAN. Confirm that the Ethernet port light next to the Ethernet port is green. If it is not, unplug the cable and plug it in again.
There may be a problem with the office network.	<ul style="list-style-type: none"> Check if other network devices, such as computers, are communicating with the network. If not, then contact your IT administrator.

The screen displays Synch Failed.

Probable Cause	Corrective Action
The device synch failed when trying to connect to the system.	<ul style="list-style-type: none"> Reset the device. Insert a pen or paper clip into the reset hole and press for more than five seconds.
The maximum number of that type of device has been reached.	<ul style="list-style-type: none"> A device must be removed from the network and deleted from the system before another device can be added.



Probable Cause	Corrective Action
The same Deskset extension number already exists.	<ul style="list-style-type: none"> Reset the Deskset to factory defaults without the network cable connected. Use a paper clip to press and hold the reset switch for more than five seconds.
The device software version is different than the rest of the system.	<ul style="list-style-type: none"> Ask your system administrator to update all devices to the current software version.

The device screen displays **Synchronizing...**

Probable Cause	Corrective Action
Not enough time has elapsed.	<ul style="list-style-type: none"> The device may display Synchronizing... for a few seconds. This is normal and does not indicate a problem.

Deskset cannot make or receive phone calls and the Deskset screen displays **Synchronizing...**

Probable Cause	Corrective Action
The Deskset may have an incompatible software version.	<ul style="list-style-type: none"> Ask your system administrator to update your Deskset to the current software version.



Calls Generally

Calls are dropped.

Probable Cause	Corrective Action
Restoring Deskset settings or updating software while that extension is in use will cause all calls to be dropped.	<ul style="list-style-type: none"> Your system administrator should avoid updating software or restoring Deskset settings when you are likely to be using the phone.
The network is down.	<ul style="list-style-type: none"> Ensure that the Ethernet cable is securely plugged into the network port beneath your Deskset labeled  and that the other end is plugged into your office LAN.
The Deskset extension was changed during the call.	<ul style="list-style-type: none"> Contact your system administrator. If changes were made to your extension while you were on a call, that call is dropped.
Maximum Call Duration was exceeded.	<ul style="list-style-type: none"> None. Outside calls that you transfer or forward to another outside number use two lines. The duration of such calls is limited by a timer that your system administrator sets.

Deskset cannot make or receive phone calls

Probable Cause	Corrective Action
Putting the T1 Gateway into loopback test mode prevents phone calls from occurring.	<ul style="list-style-type: none"> Do not run loopback tests while the T1 trunk is in use.
Your Deskset is not synchronized.	<ul style="list-style-type: none"> Press MENU → 4 to verify that the Deskset Status is Synchronized. See “Deskset cannot make or receive phone calls and the Deskset screen displays Synchronizing...” on page 219.
Your Deskset is not connected to the LAN.	<ul style="list-style-type: none"> Ensure that the Ethernet cable is securely plugged into the network port beneath your Deskset and that the other end is plugged into your office LAN.

On outside calls, you hear an excessive echo at the Deskset.

Probable Cause	Corrective Action
The automatic PSTN Gateway line calibration did not run properly.	<ul style="list-style-type: none"> See your system administrator. There may be non-system equipment connected in parallel to the telephone line.



You cannot retrieve parked calls.

Probable Cause	Corrective Action
The first digit of an extension number matches the first digit of parked calls.	<ul style="list-style-type: none"> Your system administrator may have to correct your Dial Plan settings. Do not have extension numbers whose first digits match the park extension prefix.

You hear static, sudden silences, gaps in speech, or garbled speech.

Probable Cause	Corrective Action
You may be experiencing network problems.	<ul style="list-style-type: none"> Your LAN administrator should ensure the following minimum guidelines are met: <ul style="list-style-type: none"> A switched network topology is recommended (using standard 10/100 Ethernet switches that carry traffic at a nominal rate of 100 Mbit/s). The office network infrastructure should use Cat.-5 wiring. Do not connect a network server PC to the PC port on the Deskset. Make sure the network cable is securely plugged in. If you tug on the cable, the plug should remain inserted.

A call is forwarded or transferred to an outside telephone number and the call is disconnected.

Probable Cause	Corrective Action
Telephone line-to-telephone line call times have been restricted. Calls that are forwarded or transferred to an outside phone number use two PSTN lines or voice channels for the duration of the call. To avoid tying up two outside lines, these calls are on a timer.	<ul style="list-style-type: none"> Ask your system administrator to reset the Timer for Forwarded and Transferred Outside Calls.



You are unable to transfer a call to an extension.

Probable Cause	Corrective Action
The extension is unavailable.	<ul style="list-style-type: none"> ■ Check if the destination extension is disconnected from the network. ■ Ensure that the extension exists. ■ All the destination extension's lines may be busy. ■ If the party you have on hold hangs up, call back and start the transfer process again.

Your Deskset does not automatically forward a call to another extension.

Probable Cause	Corrective Action
Call Appearance mode only — The Call Forward All settings are incorrect.	<ul style="list-style-type: none"> ■ Check that Call Forward All is on (FWD ON should appear in the top right corner of the screen while in Idle mode). ■ Ensure that a valid extension number has been entered as a destination extension. ■ Confirm that the Call Forward All Target is set to EXT.

You are unable to transfer a call to an outside phone number.

Probable Cause	Corrective Action
Call Appearance mode only — Transferring to an outside phone number has been disabled, or no lines are available.	<ul style="list-style-type: none"> ■ Check that your system administrator has enabled transferring to an outside phone number. ■ Ensure that a valid outside number is shown in the to Phone # field. Enter a 9 or whatever digit, if any, that must be dialed first for an outside call. ■ Ensure that the Gateway is connected to the network. ■ All phone lines may be in use. If so, try again later.



Deskset does not automatically forward a call to an outside phone number.

Probable Cause	Corrective Action
Forwarding to an outside phone number has been disabled or Call Forward All or the Call Forward–No Answer settings are incorrect.	<ul style="list-style-type: none"> ■ Call Appearance mode only — Check that Call Forward All is on. FWD ON should appear in the top right corner of the screen while in Idle mode. Press CallFwd to turn this feature on. ■ Call Appearance mode only — Ensure that a valid outside number is shown in the to Phone # field. Enter a 9 or whatever digit, if any, that must be dialed first for an outside call. ■ Call Appearance mode only — Confirm that the Call Forward All Target is set to Phone #. On the Deskset, press MENU → 2 → 2. ■ Check that forwarding to an outside phone number has been enabled. Your system administrator must enable Call Fwd/Transfer to line in the Admin Settings.

You are unable to manually forward a call to Voicemail.

Probable Cause	Corrective Action
Call Appearance mode only — You cannot forward incoming Ring Group calls and incoming Call Queue calls to Voicemail.	<ul style="list-style-type: none"> ■ Nothing. The system administrator can designate a Deskset as a forwarding destination if the Ring Group call is unanswered. If that Deskset does not answer the forwarded call, the call will be forwarded again according to that Deskset's settings.



Incoming Calls

Your Deskset does not receive incoming calls.

Probable Cause	Corrective Action
Incoming call notifications have been suppressed or delayed, or incoming calls are redirected by the Deskset, or incoming calls are not directed to the Deskset.	<ul style="list-style-type: none"> Verify that Do Not Disturb is off. Make sure that DND ON is not in the top right corner of the Deskset display. Turn this feature off by using the Deskset Idle screen soft keys. Verify that Call Forward All is off. Make sure that FWD ON is not in the top right corner of the Deskset display. Turn this feature off by using the Deskset Idle screen soft keys. Incoming calls may be directed to a Ring Group or Call Queue that you are not part of. Calls may also be redirected via DID numbers and Trunk Routing.
The ringer volume is too low or a ring delay is set.	<ul style="list-style-type: none"> Press the VOL+ key to increase ringer volume. Verify that the Audible Ring Delay is off. Press MENU → 1 → 2 at a Deskset to adjust the ring delay.

You receive only caller ID numbers, not caller ID names.

Probable Cause	Corrective Action
Your T1 telephone service provider may use DMS-100 or 5ESS signalling protocols, which do not support caller ID name delivery.	<ul style="list-style-type: none"> Talk to the service provider about obtaining PRI-NI2 signaling.

Call Appearance mode only — Outside caller cannot find your extension in the Auto Attendant Directory.

Probable Cause	Corrective Action
You have not recorded a Personal Name.	<ul style="list-style-type: none"> Record a name at the Deskset. Press MENU → 2 → 5 to record a Personal Name to be played to callers.
Your system administrator has not entered your first and last name into the Extension List.	<ul style="list-style-type: none"> Consult your system administrator.
The outside caller may not be waiting long enough for the search.	<ul style="list-style-type: none"> Tell callers that after spelling the name, they can press the pound (#) sign to start the search.



Call Appearance mode only — Call does not Auto Answer.

Probable Cause	Corrective Action
The Deskset is set to Call Forward All.	<ul style="list-style-type: none"> Deactivate Call Forward All. On the Idle screen, press CallFwd.
The Deskset is in DND mode.	<ul style="list-style-type: none"> Deactivate DND. On the Idle screen, press DND.
Your Auto Answer delay is greater than your Call-Forward – No Answer delay.	<ul style="list-style-type: none"> Adjust the Auto Answer delay. On the Deskset, press MENU → 2 → 3.
Ring Group calls cannot be automatically answered.	<ul style="list-style-type: none"> If your location has a T1 Gateway and DID numbers, ask your system administrator to assign a DID number to your extension and ask people whose calls you want auto answered to dial your DID number.

Caller ID is not working. The display shows ◀ Phone# ▶ and a digit for the name, and the same digit for the phone number.

Probable Cause	Corrective Action
Your organization does not subscribe to caller ID service or you have DSL phone lines without filters installed.	<ul style="list-style-type: none"> Caller ID is a subscription service. You must subscribe to this service from your local telephone service provider for this feature to work on your phone. The caller must be calling from an area that supports caller ID. Both you and your caller's telephone companies must use caller ID compatible equipment. If you have DSL phone lines, confirm that you have a DSL filter plugged in between each Deskset and DSL wall jack. The DSL filter must be plugged into the wall jack, not the Gateway.



Outgoing Calls

No dial tone.

Probable Cause	Corrective Action
Handset cord is plugged into the wrong jack.	<ul style="list-style-type: none"> Ensure the handset cord is plugged into the handset jack on the side of the Deskset. Do not connect the handset cord to the corded headset jack on the back of the Deskset.

When you dial an outside number, you reach an extension instead.

Probable Cause	Corrective Action
The extension prefix matches the first digit of the outside phone number you tried to dial, and you don't have to dial a digit before dialing outside phone numbers.	<ul style="list-style-type: none"> Consult your system administrator.

You cannot make calls to an outside number.

Probable Cause	Corrective Action
An outside phone number cannot be accessed through the Gateway.	<ul style="list-style-type: none"> Ensure that you enter a 9 or whatever digit, if any, that must be dialed first for an outside call. For example, 9-1-555-0123. If you see All Phone Lines Busy on the Deskset screen, try again later because all outside lines may be in use. Ensure that a Gateway is connected to the network and that it resides on the same subnet as the Deskset.
Call Appearance mode only — Your extension has a trunk reservation for outgoing calls, and all lines and channels are being used for active or incoming calls, or are reserved for other extensions.	<ul style="list-style-type: none"> Wait for a channel or line to become available. The system administrator can either remove the reservations from some trunks or contact the service provider to add more analog telephone lines or T1 channels.



You cannot make international long distance calls.

Probable Cause	Corrective Action
Call Appearance mode only — If you don't need to dial an extra digit (such as 9) to make an outside call, phone numbers that start with 0 (including international or country codes), will go to the Synapse system operator.	<ul style="list-style-type: none"> ■ Consult your system administrator.
Your Deskset is call restricted.	<ul style="list-style-type: none"> ■ None.

You cannot access phone company services like 411.

Probable Cause	Corrective Action
Call Appearance mode only — If any x11 extensions already exist (such as 411, or 611), then the extensions take precedence. In other words, dialing 411 calls extension 411, not the 411 directory service. 911 cannot be assigned as an extension number.	<ul style="list-style-type: none"> ■ Consult your system administrator. ■ Ensure that you enter a 9 or whatever digit, if any, that must be dialed first for an outside call. For example, 9-1-555-0123.

Call Appearance mode only — The PSTN Trunk reservation is not being honored.

Probable Cause	Corrective Action
An incoming call may be using that line. Parking calls and forwarding calls on a reserved trunk does not free up the trunk.	<ul style="list-style-type: none"> ■ Consult your system administrator about setting up Trunk Routing to reserve the incoming path to the "special" extension. ■ A Forwarded call must end before the reserved trunk is available.

DDNs (Directory Dial Numbers) do not dial out properly from the Call Log.

Probable Cause	Corrective Action
This system does not support DDN.	<ul style="list-style-type: none"> ■ DDNs in the Call Log are treated like all other caller ID phone numbers.



Voicemail

Voicemail is not received at the extension you called.

Probable Cause	Corrective Action
Target extension Voicemail is full.	<ul style="list-style-type: none"> ■ Delete messages.
Extension is unplugged.	<ul style="list-style-type: none"> ■ Plug in the extension.
Distribution List error.	<ul style="list-style-type: none"> ■ Verify the Distribution List. Log in to the WebUI, then click Voicemail Distribution.

Your Deskset does not receive Voicemail.

Probable Cause	Corrective Action
Calls are not being directed to Voicemail, or the Voicemail memory is full.	<ul style="list-style-type: none"> ■ Call Appearance mode only — Verify that Call Forward All is off or is targeted to Voicemail. <ul style="list-style-type: none"> ● Press CallFwd to turn this feature off. FWD ON will not be in the top right corner of the Deskset display. ● To set the Call Forward All target, log in to the WebUI. On the Basic Settings page, set the Target Type to Voicemail. Then click Apply. ■ Ask the system administrator to check the Call Forward – No Answer setting. Calls may be forwarding to another phone number instead of Voicemail. ■ Check your available Voicemail memory. You may need to delete some messages to create space.

Call Appearance mode only — The number of new messages or all messages does not match on Cordless Handset and Deskset.

Probable Cause	Corrective Action
Cordless Handsets registered to Desksets that have access to Group Mailboxes do not recognize the messages in the Group Mailboxes.	<ul style="list-style-type: none"> ■ None. The optional Cordless Handsets do not have access to Group Mailboxes. Therefore, Group Mailbox messages do not appear on the Handset.



Incomplete Voicemail messages.

Probable Cause	Corrective Action
Recording interrupted by time-out or full memory.	<ul style="list-style-type: none"> ■ If a caller leaves a very long message, part of it may be lost when the Deskset disconnects the call after two minutes. ■ If the caller pauses for longer than six seconds, the Deskset stops recording and disconnects the call. ■ If the Deskset's memory becomes full during a message, the Deskset stops recording and disconnects the call. ■ If the caller's voice is very soft, the Deskset may stop recording and disconnect the call.

Unable to find a message in a Group Mailbox.

Probable Cause	Corrective Action
Group Mailboxes are accessed by multiple users.	<ul style="list-style-type: none"> ■ None. Group Mailboxes are accessed by multiple users. Messages can be marked as old or deleted by other users.

The number of new messages in a Group Mailbox changed spontaneously.

Probable Cause	Corrective Action
Group Mailboxes are accessed by multiple users.	<ul style="list-style-type: none"> ■ None. Group Mailboxes are accessed by multiple users. Messages can be marked as old or deleted by other users.



The system does not respond to remote Voicemail commands.

Probable Cause	Corrective Action
The system cannot detect Dual-Tone Multi-Frequency (DTMF) tones, which are the signals sent when the caller presses dial-pad keys.	<ul style="list-style-type: none">■ Confirm you have entered star, star (**) before entering your remote access code (user password). If you have no password, press star, star (**), then pound (#).■ Confirm you are calling from a touch-tone phone. When you dial a number, you should hear tones. If you hear clicks, the phone is not a touch-tone telephone and cannot activate the answering system.■ The answering system might not detect the star, star (**) while your announcement is playing. Try waiting until the announcement is over before entering the code.■ There may be interference on the phone line you are using. Press the dial-pad keys firmly.



Other Deskset Features

Other Desksets do not appear in the extension list.

Probable Cause	Corrective Action
The Deskset is not connected to the same subnet as the other Desksets.	<ul style="list-style-type: none"> Verify that the first two sections of the IP address (the portion before the second "dot") match the IP addresses of the other Desksets or that the subnets are set up to communicate with each other. Press MENU → 4 at a Deskset to find the IP address. If the other Desksets have been assigned static IP addresses, you may have to assign your Deskset a static IP address to match the other Desksets.

You are unable to record a greeting.

Probable Cause	Corrective Action
Call Appearance mode only — The selected Deskset is set up to forward all calls.	<ul style="list-style-type: none"> Disable the call forwarding on the selected Deskset. Press CallFwd. Select a different Deskset on which to record the greeting.

There is no **DistrList** key so you cannot forward messages to a Distribution list.

Probable Cause	Corrective Action
The DistrList key is not present unless the Distribution List feature is enabled and you have created at least one Distribution List.	<ul style="list-style-type: none"> Log into the WebUI and click Voicemail Distribution. Enable Voicemail Distribution, and create one or more Distribution Lists.

Your Deskset soft keys have changed.

Probable Cause	Corrective Action
The highlight bar has moved to another line on the screen.	<ul style="list-style-type: none"> None. The soft keys reflect the call state and Deskset functions. They change depending on which line is highlighted. <p>For example, there may be a held call, an active call, or an incoming call on the screen. To view the soft keys for that call, move the highlight bar by pressing △ or ▽.</p>



You are unable to add an entry to Quick-Dial list.

Probable Cause	Corrective Action
If you have an SB67030/031 Deskset, the Quick-Dial list is full — there are six entries available.	<ul style="list-style-type: none"> ■ Edit Quick-Dial entries on the Deskset to write over an existing entry: <ol style="list-style-type: none"> a. Press the button to the right of . b. Press Edit List to add or edit a Quick-Dial entry. ■ Edit Quick-Dial entries on the WebUI to write over an existing entry: <ol style="list-style-type: none"> a. Log in to the WebUI and click Quick Dial Keys. b. Edit the Quick-Dial entries. c. Click Apply.
Your SB67030/031 Deskset has been configured for Call Queue. The Quick-Dial key and Quick-Dial list are unavailable.	<ul style="list-style-type: none"> ■ See your system administrator if you need to use Quick Dial instead of Call Queue.
If you have an SB67020 Deskset, the system administrator must configure one or more Programmable Feature Keys as Quick Dial keys before they can be used.	<ul style="list-style-type: none"> ■ Ask your system administrator to configure one or more Quick-Dial keys for your Deskset.

You are unable to locate the Cordless Handset from the Deskset.

Probable Cause	Corrective Action
The Cordless Handset's battery is dead.	<ul style="list-style-type: none"> ■ Charge the Cordless Handset battery.
The Cordless Handset is out of range or not registered.	<ul style="list-style-type: none"> ■ If LocateHS does not appear on the Deskset Idle screen, then the Cordless Handset is not registered. Register the Handset at the Deskset. Press MENU → 2 → 6 → 1 → Register.
You deregistered the Cordless Handset on the Handset, but the Deskset still indicates it is registered.	<ul style="list-style-type: none"> ■ Deregister the Cordless Handset on the Deskset. On the Deskset, press MENU → 2 → 6. If the Handset is registered, the screen indicates 1. Handset (Registered). Press 1 → DeReg to deregister the Handset.



Call Appearance mode only — You cannot make or receive phone calls on the T1 channels.

Probable Cause	Corrective Action
Incoming or outgoing calls using the T1 trunk are attempted before the SYN/ACT LED is GREEN .	<ul style="list-style-type: none">■ Press the RESET button on the front panel of the T1 Gateway for less than 5 seconds.■ Wait for the SYNC LED to turn GREEN before making or receiving any T1 calls or receiving calls on the T1 Gateway.



WebUI

Unable to access the WebUI Log-in page from my computer.

Probable Cause	Corrective Action
The computer is not connected to the same subnet (network) as the Deskset, and the subnets are not set up to communicate.	<ul style="list-style-type: none">■ Verify the IP address. You must correctly enter the IP address of your Deskset into your Internet browser's address bar. At the Deskset, press MENU → 4 to see the IP address displayed in the third line of the information.■ Ensure that there is an Ethernet cable attached to Network port on the Deskset and to the LAN. If a PC at the same workstation is sharing the LAN connection, attach an Ethernet cable to your computer's Ethernet port and to the PC port on the back of the Deskset.■ Confirm that your computer and your Deskset are on the same subnet so that they can talk to each other. Check that the first three sections of each IP address are the same. If they are not, they may not be connected to the same subnet. Contact the installer; the subnets may not be set up to communicate.



Changes made in the WebUI are not saved.

Probable Cause	Corrective Action
<input type="button" value="Apply"/> must be clicked on each page to confirm the changes.	<ul style="list-style-type: none">■ Click <input type="button" value="Apply"/> on each page to confirm the changes.



PC/Deskset Interaction

Internet connection or access to the local network on your computer does not work after installing the Deskset.

Probable Cause	Corrective Action
The Ethernet cords are not installed correctly.	<ul style="list-style-type: none"> Check that the Ethernet cord from the computer is plugged into the Deskset port labeled . A second Ethernet cord should be plugged into the Ethernet port on the Deskset marked  with the other end plugged into your LAN.

Your PC is slower after connecting it to the LAN through the Deskset.

Probable Cause	Corrective Action
A computer connected through the Deskset will be limited to 100 Mbits/s.	<ul style="list-style-type: none"> Use separate Ethernet connections for the Deskset and the computer so that the computer can take advantage of the network's greater bandwidth.

Your PC, which is connected to the LAN through the Deskset, briefly loses its network connection.

Probable Cause	Corrective Action
For PCs connected to the LAN through Desksets, disruption to the Deskset operation affects the PC. For example, when the Deskset restarts (possibly due to a software upgrade) the connection to the LAN is temporarily lost.	<ul style="list-style-type: none"> If the PC is connected to the LAN through the Deskset, your system administrator should avoid updating software or restoring Deskset settings when you are using the workstation. If the PC is connected to the Deskset, and if the PC is connected to an Uninterruptible Power Supply (UPS), plug the Deskset into a UPS. Use separate Ethernet connections for the Deskset and the computer.



SB67040 Cordless Handset

Handset does not work at all (LCD is black).

Probable Cause	Corrective Action
There is no power to the device.	<ul style="list-style-type: none"> ■ Confirm the battery is installed and charged correctly. ■ Place the Handset into the charger. Ensure the charger is securely plugged into an outlet not controlled by a wall switch. The Charge LED on the charger should light and the Handset display should indicate that the Handset is charging. ■ Verify that the charger's AC power outlet has power, such as plugging in some other AC device. If nothing works, contact an electrician or use another power outlet. ■ If the battery is completely depleted, it can take up to 10 minutes to charge the battery before the low battery icon appears.

Extension number does not match the Deskset.

Probable Cause	Corrective Action
The Handset has been registered to another Deskset.	<ol style="list-style-type: none"> 1. Check the Deskset to see if a Handset has been registered. If so, deregister it. On the Deskset, press MENU → 2 → 6. If the Handset is registered, the screen indicates 1. Handset (Registered). Press 1 → DeReg to deregister the Handset. 2. Deregister your Handset. On the Handset, press OPTIONS → 5 → 4. 3. Start the registration process again. Register the Handset at the Deskset. Press MENU → 2 → 6 → 1 → Register.

Unable to create new Directory or Quick-Dial entry.

Probable Cause	Corrective Action
This feature is not supported on the Handset.	<ul style="list-style-type: none"> ■ None. Although you can access the Directory or Quick Dial on the Handset, you can create, delete, or edit entries only on the Deskset or WebUI.



Handset registration is not working.

Probable Cause	Corrective Action
The Handset and the Deskset are not communicating with each other.	<ul style="list-style-type: none"> ■ Confirm you have placed the Handset in the charger and check that the screen on the Handset turns on before you press the Register soft key on the Deskset. ■ If registration does not start, try lifting the Handset out of the charger for a few seconds before placing it back. ■ The Handset may indicate that it is registered but the Deskset indicates that it is not registered. <ul style="list-style-type: none"> ● Deregister the Handset at the Handset. Press OPTIONS → 5 → 4. ● Register the Handset at the Deskset. Press MENU → 2 → 6 → 1 → Register .
The Synapse system is in Line Appearance mode.	<ul style="list-style-type: none"> ■ None. Because the Handset does not operate in Line Appearance mode, it deregisters from the Deskset.

Unable to make outside calls.

Probable Cause	Corrective Action
The Deskset cannot make outside calls.	<ul style="list-style-type: none"> ■ Ensure that the Deskset can make outside calls. For more information, see “Outgoing Calls” on page 226.
The Handset cannot communicate with the Deskset.	<ul style="list-style-type: none"> ■ Confirm that your Handset is registered to your Deskset. On the Handset, press OPTIONS → 5 → 5 and check that the bottom line reads Registered: YES. ■ You might be out of range of the Deskset; try moving closer. If you see the Idle screen, then the Handset is successfully communicating with the Deskset.

Handset does not receive incoming calls.

Probable Cause	Corrective Action
The Deskset cannot receive outside calls.	<ul style="list-style-type: none"> ■ Ensure that the Deskset can make outside calls. For more information, see “Outgoing Calls” on page 226.



Probable Cause	Corrective Action
The incoming call notifications have been suppressed.	<ul style="list-style-type: none"> Verify that Do Not Disturb is off. Make sure that DND is not in the top right corner of the Handset display. Turn this feature off by using the Deskset Idle screen soft keys. Verify that Call Forward All is off. Make sure that CFWD is not in the top right corner of the Handset display. Turn this feature off by using the Deskset Idle screen soft keys. If the Handset does not ring for an incoming call, press < VOLUME > on the side of the Handset to increase ringer volume.
Incoming call notifications do not reach the Handset.	<ul style="list-style-type: none"> Confirm that your Handset is registered to the Deskset. At the Deskset, press MENU → 2 → 6. If the Handset is registered, the screen displays 1. Handset (Registered). At the Handset, verify that the Handset is registered. Press OPTIONS → 5 → 5 and check that the screen displays Registered: YES. Verify that the extension numbers are the same on both the Deskset and Handset Idle appears. If they do not match, the Handset is registered to another Deskset. You might be out of range of the Deskset; move closer.

Unable to locate Handset using **LocateHS** on the Deskset.

Probable Cause	Corrective Action
The Handset is not registered.	<ul style="list-style-type: none"> If the LocateHS soft key does not appear on the Deskset, then the Handset is not registered. On the Deskset, press MENU → 2 → 6 → 1 → Register .
The Handset battery is dead.	<ul style="list-style-type: none"> Place the Handset into the charger.
The Handset is out of range.	<ul style="list-style-type: none"> Move the Handset closer to the Deskset.



Handset shows screen telling you to register it, but Deskset screen says that the Cordless Handset is registered.

Probable Cause	Corrective Action
Sometimes, when you deregister a Cordless Handset from the Deskset, the Deskset does not reflect the Cordless Handset's new, unregistered status.	<ul style="list-style-type: none"> ■ Deregister the Handset, then reregister the Handset. <ol style="list-style-type: none"> a. On the Deskset, press MENU → 2 → 6 → 1 → DeReg . b. On the Deskset, press MENU → 2 → 6 → 1 → Register .

Handset displays Deskset in Use when trying to make a call.

Probable Cause	Corrective Action
Either the Deskset or its registered Handset can be on a call, but not both.	<ul style="list-style-type: none"> ■ Hang up the call at the Deskset. ■ Move the current call to the Handset: <ul style="list-style-type: none"> ● Press PHONE on the Handset. The Handset asks if you wish to switch the current active call from the Deskset to the Handset. ● Press SWITCH on the Handset to move the call to the Handset.

Handset continuously displays Searching for Deskset....

Probable Cause	Corrective Action
The Handset is out of range or not registered.	<ul style="list-style-type: none"> ■ Verify that the Deskset is powered and fully functional. If the Deskset has no AC power, the Handset will not work. ■ The Handset may be out of range of the Deskset; move closer. ■ The Handset may have been deregistered when the Deskset was upgraded or reset. Deregister the Handset at the Handset; then, at the Deskset, register the Handset again: <ol style="list-style-type: none"> a. On the Handset, press OPTIONS → 5 → 4. b. On the Deskset, press MENU → 2 → 6 → 1 → Register .



Caller ID is not working.

Probable Cause	Corrective Action
Your organization does not subscribe to this service.	<ul style="list-style-type: none"> ■ Caller ID is a subscription service. You must subscribe to this service from your local telephone company for this feature to work on your phone. ■ The caller must be calling from an area that supports caller ID. ■ Both you and your caller's telephone companies must use caller ID compatible equipment.
You have DSL phone lines without filters installed.	<ul style="list-style-type: none"> ■ If you have DSL phone lines, make sure you have a DSL filter plugged in between each DSL line and the wall jack. The DSL filter must be plugged into the wall jack, not the Gateway.

Calls dropped.

Probable Cause	Corrective Action
Restoring Deskset settings while that extension is in use causes all calls to be dropped.	<ul style="list-style-type: none"> ■ Update software and restore Deskset settings only in Idle mode with no calls pending.
Cordless Handset lost connection to the Deskset.	<ul style="list-style-type: none"> ■ Verify that your Cordless Handset battery is charged and that it is within range of the Deskset. ■ Update software and restore Deskset settings only in Idle mode with no calls pending.
The network is down.	<ul style="list-style-type: none"> ■ Verify that your office network is active and that your Deskset has power. ■ Ensure that the Ethernet cable is securely plugged into the network port beneath your Deskset labeled  and that the other end is plugged into your office LAN.
The telephone line was disconnected while on an outside call.	<ul style="list-style-type: none"> ■ Ask the system administrator to check the connections between the Gateways and the telephone service.

Unable to find a way to turn on Do Not Disturb or Call Forward All.

Probable Cause	Corrective Action
These functions can only be enabled on the Deskset.	<ul style="list-style-type: none"> ■ To activate Do Not Disturb (DND) or Call Forward All, press DND or CallFwd on the Deskset while in Idle mode.



Poor audio quality. Speech is cutting out.

Probable Cause	Corrective Action
The Handset is almost out of range or is experiencing interference.	<ul style="list-style-type: none"> You may be close to being out of range. Try moving closer to the Deskset. Other electronic products can cause interference with your Handset. Try installing the Deskset far away from devices such as televisions, microwaves, or other cordless devices, including other Handsets.
The Deskset audio is poor.	<ul style="list-style-type: none"> Check audio quality on the Deskset. If a problem exists, contact your system administrator.

Your Handset does not receive a company-wide page.

Probable Cause	Corrective Action
This feature is not supported on the Handset.	<ul style="list-style-type: none"> None. The Handset can send a page but not receive one. The page is transmitted to all Desksets in the network.

Unable to Forward Voicemail to a Group Mailbox or Distribution List.

Probable Cause	Corrective Action
This feature is not supported on the Handset.	<ul style="list-style-type: none"> None.



TL7600 Cordless Headset

The TL7600 Headset not responding.

Probable Cause	Corrective Action
The Headset has lost connection to the Deskset.	<ol style="list-style-type: none"> 1. Disconnect the Cordless Headset battery. 2. Wait three minutes. 3. Install the battery again and place the Cordless Headset into the charger. 4. Wait for the ON/OFF light on the Headset to display a blue light, indicating that the Headset was able to reestablish its connection with the Deskset. Allow up to one minute for this to take place.

The light on the TL7600 Headset flashes orange and blue; the Headset does not work.

Probable Cause	Corrective Action
The Headset is not registered.	<ul style="list-style-type: none"> ■ Register the Headset at the Deskset. On the Deskset, press MENU → 2 → 6 → 2 → Register (Call Appearance mode) or MENU → 2 → 3 → 2 → Register (Line Appearance mode). ■ Once the Headset is registered, the Headset light is blue when the Headset is placed in the charger.



The TL7600 Headset does not work at all.

Probable Cause	Corrective Action
The Headset is not getting power from its battery.	<ul style="list-style-type: none"> ■ Verify that the battery is installed and charged correctly. ■ Place the Headset into the accessory charger. Ensure the charger is securely plugged into an outlet not controlled by a wall switch. The Headset LED will light to indicate that the Headset is charging. ■ If the battery is completely depleted, it can take up to 10 minutes to charge the battery enough for the Headset to work even briefly. In this case, the ON/OFF LED will remain off and you will not be able to use the device. After 10 minutes of charging, remove the Headset from the charger and press ON/OFF on the Headset or HEADSET on the Deskset to turn on the Headset. ■ Replace the Headset battery.

The TL7600 Headset registration is not working.

Probable Cause	Corrective Action
The Headset and the Deskset are not communicating with each other.	<ul style="list-style-type: none"> ■ Confirm that you have placed the Headset in the charger before you press Register on the Deskset. ■ If registration does not start, try lifting the Headset out of the charger for a few seconds before placing it back.

Poor audio quality. Speech is cutting out.

Probable Cause	Corrective Action
The Headset is almost out of range or is experiencing interference.	<ul style="list-style-type: none"> ■ You may be close to being out of range. Try moving closer to the Deskset. ■ Other electronic products can cause interference with your Headset. Try installing the Deskset far away from devices such as televisions, microwaves, or other cordless devices. ■ If the problem persists, check audio quality on the Deskset and/or contact your system administrator.



HEADSET key on Deskset does not work.

Probable Cause	Corrective Action
Headset is in the charger or powered down.	<ul style="list-style-type: none"> Confirm that the Headset is out of its charger before you press HEADSET. Confirm that the Headset has sufficient power. If the Headset does not respond and the blue light does not blink, the battery may have no charge. Place the Headset in the charger for at least six hours.

MUTE key on the Deskset does not mute the Headset.

Probable Cause	Corrective Action
MUTE keys on Deskset and Headset operate separately.	<ul style="list-style-type: none"> None. Only the MUTE key on the Headset mutes calls. The MUTE key on the Deskset does not work with the Headset.

No dial tone.

Probable Cause	Corrective Action
Headset cannot communicate with Deskset.	<ul style="list-style-type: none"> Verify that the Deskset can make outside calls. For more information, see "Outgoing Calls" on page 226 You may be out of range of the Deskset; move closer. At the Deskset, confirm that your Headset is registered to the Deskset. On the Deskset, press MENU → 2 → 6 (Call Appearance mode) or MENU → 2 → 3 (Line Appearance mode). If the Headset is registered, the screen indicates 2. Headset (Registered).



Batteries do not hold a charge.

Probable Cause	Corrective Action
Bad battery or bad battery connection.	<ul style="list-style-type: none"> ■ Make sure that the Headset battery is installed and securely plugged into the connector. ■ Charge the battery for at least six hours. For optimum daily performance, return the Cordless Headset to the charger when not in use. ■ You may need a new battery. ■ Your Headset might be malfunctioning. Contact the headset manufacturer.

The Deskset shows no indication that the Headset is on a call.

Probable Cause	Corrective Action
The Headset is registered to another Deskset. If others are using Headsets in your vicinity, someone may have accidentally registered your Headset to their Deskset.	<ul style="list-style-type: none"> ■ If nearby people have Headsets, they may have accidentally registered your Headset to one of their Desksets. <ol style="list-style-type: none"> a. Verify that a Headset is registered to your Deskset. On the Deskset, press MENU → 2 → 6 (Call Appearance mode) or MENU → 2 → 3 (Line Appearance mode). If the Headset is registered, the screen indicates 2. Headset (Registered). b. If a Headset is registered, it may not be yours. Deregister your Headset from the Deskset, and ask all users in the vicinity to deregister their Headsets. At a Deskset, press MENU → 2 → 6 → 2 → DeReg (Call Appearance mode) or MENU → 2 → 3 → 2 → DeReg (Line Appearance mode). c. Start the registration process again, but with one user at a time registering a Headset. At a Deskset, press MENU → 2 → 6 → 2 → Register (Call Appearance mode) or MENU → 2 → 3 → 2 → Register (Line Appearance mode).



A buzzing sound on my TL7600 Headset.

Probable Cause	Corrective Action
Noise interference.	<ul style="list-style-type: none"> ■ Move the Headset at least 12 inches away from the Deskset. ■ Other electronic products can cause interference with your Cordless Headset. Try using your Headset as far away from these types of electronic devices as possible: television sets, microwaves, or other cordless telephones.

Unable to deregister TL7600 Headset.

Probable Cause	Corrective Action
The Deskset is unavailable (powered off, out of range, or removed from the system).	<ul style="list-style-type: none"> ■ Deregister the Headset at the Headset. Press: VOL+ -> MUTE -> VOL- -> MUTE -> VOL+ -> VOL- -> MUTE.
You cannot identify or locate the Deskset that the Headset is registered to.	<ul style="list-style-type: none"> ■ If the Headset is registered to an unknown Deskset which has AC power, you must carry the Headset out of range of the Deskset and perform the Deregistration sequence described above. You will know when the Headset is out of range when you press ON/OFF and you hear three beeps and no dial tone.



APPENDIXES

Appendix A: Soft Keys

The Synapse Desksets and Cordless Handsets feature keys below the LCD screen. The bottom of the LCD displays the appropriate label for each key as the function of the key changes.

Deskset Soft Keys

Table 25 provides an alphabetical list of the labels that appear above the Deskset soft keys.

Table 25. Deskset Soft Key Functions

Function	Description	Function	Description
AddExt	Adds an extension destination when forwarding a Voicemail message.	Conf	Initiates a conference call.
Answer	Answers an incoming call.	Confirm	Confirms that DND is on.
Back	Goes back to Idle; in HELP menus, goes back to previous page.	DelAll	Deletes multiple records.
Backspc	Backspace the cursor when entering data.	Delete	Deletes a record.
Call	Dials the selected entry.	DelExt	Removes an extension destination when forwarding a Voicemail message.
CallFwd	Turns Call Forward on or off.	DelMsg	Deletes the highlighted Voicemail message in the Message list.
Cancel	Cancels action and returns user to previous mode.	DeReg	Deregisters Cordless Handset or Headset in registration menu.
Clear	Clears the active Call Screening indication (●●) from the Call Appearance screen.	Details	Shows more detail for a particular entry.
ClerNew	Clears NEW indications from all messages.	DistrList	Shows the Voicemail Distribution List.
		DND	Turns Do Not Disturb on and off.
		Drop	Drops a selected call during a three-way conference.



Table 25. Deskset Soft Key Functions (Continued)

Function	Description	Function	Description
Edit	Allows changes to previously entered information.	MB List	Goes to the Mailbox list.
EndConf	Ends conference.	More 1/2	Moves to the next set of soft keys. If this key appears, there are more than four soft keys available. More 1/2 indicates page one of two. More 1/3 indicates page one of three.
EndPage	Ends paging to all extensions.	MrkNew	Marks an old message as new.
Exit	Exits the current screen and returns to the previous menu.	New	Creates a new entry.
ExtList	Goes to the Extension list.	No	Cancels proposed action.
FwdMsg	Initiates Message Forward function.	Page	Initiates a page.
FwdVM	Forwards incoming call to Voicemail or other destination set by the administrator.	Park	Parks a call.
FirstNm	Switches between first and last name sort in the Directory and Extension lists.	ParkList	Accesses the Park list so you can review or pick up parked calls.
LastNm		Pause	Pauses message playback or inserts a two-second pause in a digit string.
HoldList	Goes to the Calls On Hold list.	Play	Plays highlighted message from Message list.
Ignore	Silences ringer during incoming call and either goes back to previous screen or goes to next incoming call.	PlayAll	Plays all Voicemail messages.
Intro	Initiates recording of an introduction when forwarding a Voicemail message.	PlayMsg	Plays message from Call Log review.
Join?	Completes conference call setup.	Record	Records an audio clip using the Deskset microphone.
◀ Jump	Jumps back eight seconds in playback mode.	Register	Registers Cordless Handset or Headset.
Jump ▶	Jumps forward eight seconds in playback mode.	Retrieve	Retrieves a parked call.
List	Opens the sort options menu in the Directory.	Save	Saves information entered.
Listen	Allows you to listen to a Voicemail message in progress.	Send	Forwards Voicemail message to selected extensions.
Ly Msg	Allows the user to create a new message and send it to Desksets on a predefined Distribution List.	Set?	Sets the selected option as the default choice.
LocateHS	Locates a registered Cordless Handset by playing a tone on the Handset.	Stop	Stops recording, playback, or listening.
		Store	Stores number in the Personal list.
		Transfer	Initiates transfer of a call.
		Xfer?	Confirms transfer.
		Yes	Confirms proposed action.



Cordless Handset Soft Keys

Table 26 provides an alphabetical list of the labels that appear above the Cordless Handset soft keys.

Table 26. Cordless Handset Soft Keys

Key	Function	Key	Function
ANSWER	Answer an incoming call. During an active call, answer the new call and put the current call on hold.	MSGs	Access Voicemail messages.
BCKSPC	Backspace the cursor when entering data.	NO	Cancel proposed action in a Confirmation screen.
CANCEL	Terminate the current operation.	PAGE	Initiate an all-extension page.
CID	Access the Call Log.	PAUSE	Pause message playback or insert a two-second pause in digit string.
CONF	Initiate a conference call.	PLAY	Play Voicemail message.
DELETE	Delete a Call Log or Redial entry.	RECORD	Record an introductory message to be added to a forwarded message.
DROP	Drop a selected call during a three-way conference.	SEND	Forward a message.
EXIT	Exit from the current screen and return to the previous mode.	STOP	Stop recording.
EXT_#s	Access the Extension list.	SWITCH	Transfer an active call from the Deskset to the Cordless Handset.
IGNORE	Silence the incoming call.	UNHOLD	Take a call off hold and return to active call.
JOIN?	Complete the conference setup.	XFER	Begin the process of transferring a held or active call and then confirm transfer.
LIST	Access the four viewing options for the Directory: All, Personal list, System list, and Extension list.	YES	Confirm proposed action.



Appendix B: Technical Specifications

Table 27 lists the technical specifications for the SB67030 Deskset, SB67031 Deskset, and SB67040 Cordless Handset.

Table 27. Technical Specifications

Feature	Specification
Frequency Control	Crystal controlled PLL synthesizer
Transmit Frequency	Deskset, Cordless Handset, Cordless Headset: 1921.536–1928.448 MHz Deskset: 1921.536–1928.448 MHz
Nominal Effective Range	Maximum power allowed by FCC (Federal Communications Commission) and IC (Industry Canada). Actual operating range might vary according to environmental conditions at the time of use.
Voice Channels	Deskset, Cordless Handset, Cordless Headset: 5
Size	Cordless Handset: 6.9" × 1.8" × 1.4" (H × W × D) Deskset: 8.2" × 8.9" × 6.5" (H × W × D)
Weight	Deskset: 59.96 oz. (1700 g) (including adapter) Cordless Handset: 7.05 oz. (200 g) (including battery)
Power Requirements	SB67030/031 Deskset: 5.1 V DC @ 1700 mA (AC Adapter) SB67031 Deskset: PoE Class 3 Cordless Handset, Cordless Headset chargers: 6 V DC @ 200 mA Cordless Handset: 2.4 V 550 mA Ni-MH battery Cordless Headset: 3.7 V 240 mAH battery
RJ-45 Ethernet Network Jack	(10Base-T/100Base-Tx) with auto MDI/MDIX switching
LAN Cable	Cat.-5 standard cable
Deskset Headset	Traditional corded handset jack type with 2-conductor wiring



Appendix C: Maintenance

**CAUTION**

Your system contains sophisticated electronic parts, so it must be treated with care.

Avoid Rough Treatment

Handle the unit gently. Save the original packing materials to protect your equipment if you ever need to ship it.

Avoid Water

Your unit can be damaged if it gets wet. Do not use the equipment outdoors in the rain or handle it with wet hands. Do not install the equipment near a sink, bathtub, or shower.

Electrical Storms

Electrical storms can sometimes cause power surges harmful to electronic equipment. For your own safety, exercise caution when using electrical appliances during storms.

Cleaning Your Unit

Your unit has a durable plastic casing that should retain its luster for many years. Clean it only with a soft cloth slightly dampened with water or a mild soap solution. Do not use excess water or cleaning solvents of any kind.



Appendix D: Important Safety Instructions



This symbol alerts you to important operating or servicing instructions in this document. Always follow basic safety precautions when using this product to reduce the risk of injury, fire, or electric shock.

When using your telephone equipment, basic safety precautions should always be followed to reduce the risk of fire, electric shock, and injury, including the following:

- Read and understand all instructions.
- Follow all warnings and instructions marked on the product.
- Unplug this product from the wall outlet before cleaning. Do not use aerosol or liquid cleaners. Use a damp cloth for cleaning.
- Do not use this product near water (for example, near a bathtub, kitchen sink, or swimming pool).
- Do not place this product on an unstable surface.
- This product should be operated only from the type of power source indicated on the marking label. If you are not sure of the type of power supply in your home or office, consult your dealer or local power company.
- Do not allow anything to rest on the power cord. Do not install this product where the cord may be walked on.
- Never push objects of any kind into this product through the slots in the unit because they may touch dangerous voltage points or create a short circuit. Never spill liquid of any kind on the product.
- To reduce the risk of electric shock, do not disassemble this product; take it to an authorized service facility. Opening or removing parts of the unit other than specified access doors may expose you to dangerous voltages or other risks. Incorrect reassembling can cause electric shock when the product is subsequently used.
- Do not overload wall outlets and extension cords.
- The power adapter is intended to be correctly oriented in a vertical or floor mount position. The prongs are not designed to hold the plug in place if it is plugged into a ceiling or an under-the-table or cabinet outlet.

Unplug this product from the wall outlet and refer servicing to an authorized service facility under the following conditions:

- When the power supply cord or plug is damaged or frayed.
- If liquid has been spilled on the product.
- If the product has been exposed to rain or water.
- If the product does not operate normally when following the operating instructions. Adjust only those controls that are covered by the operating instructions. Improper adjustment of other controls may result in damage and often requires extensive work by an authorized technician to restore the product to normal operation.
- If the product has been dropped and the unit has been damaged.
- If the product exhibits a distinct change in performance.



GLOSSARY

This glossary provides definitions that pertain to the Synapse telephone system.

active call: An established telephone call that is not on hold

analog phone: A non-Synapse telephone that plugs directly into a normal telephone wall plug or into the Synapse PSTN Gateway BYPASS port or ATA FXS port

ATA (Analog Terminal Adapter): Allows the integration of non-Synapse analog telephones, a fax machine, overhead paging equipment, and a music-on-hold source into the Synapse system. It also provides Group Mailboxes to allow different people to access the same Mailbox.

Auto Answer: When the system is in Call Appearance mode, you can set the Deskset to automatically answer calls after a delay that you specify. Without touching the Deskset, you can speak to and be heard by people who call you.

Auto Attendant: A system that automatically answers incoming calls and provides instructions to callers

Aux Out: A 3.5 mm jack on the ATA that can be used to connect some single-zone overhead paging devices.

Available (📞): A screen icon that indicates that there is a Call Appearance key that is not busy with predialing, dialing, ringing, or an active or held call

BYPASS port: An RJ-11 jack on the PSTN Gateway that allows for communication during power outages. Plug an analog telephone into this jack.

Call Appearance: The five icons on the right side of the Deskset display and the keys and LEDs associated with those icons. The keys access active and held calls, and calls that are being dialed or predialed. The LEDs and icons indicate the state of each call or potential call.

Call Forward All: Automatically forward calls before they ring. All calls are immediately forwarded to the specified destination.

Call Forward–No Answer: Automatically forward unanswered calls to Voicemail, an extension, or outside phone number

call screening: Listening to a Voicemail message while it is being recorded

Cat.-5 wiring: A twisted pair data cable commonly used in offices for computer communication

CO (Central Office): An office to which subscriber home and business lines are connected. The central office has switching equipment that can switch calls locally or to long-distance carrier phone offices.

DECT (Digital Enhanced Cordless Telecommunication): A wireless telephone technology developed specifically for cordless telephones using frequencies between 1.8 and 1.9 Gigahertz. DECT communication is resistant to interference from other electronic equipment, has longer range, and improved battery life

default: The original product settings



deregister: To remove the association between a Deskset and a Cordless Handset or Cordless Headset

dial pad: The **0** through **9**, *****, and **#** keys on the Deskset and Cordless Handset

direct dial: Allows callers to directly dial users' extension numbers after the Auto Attendant answers

Directory: A list of names and phone numbers

Display Names: The names that the system administrator enters to identify each extension number. The Auto Attendant uses these names to assist callers in forwarding calls.

DID: This feature allows outside callers to directly dial an extension, bypassing the Auto Attendant and the operator

DND (Do Not Disturb): A feature that suppresses audible ringing and incoming paging at the Deskset

DND ON (DND ON): An indicator in the top right corner of the Deskset display that illuminates when you turn on the Do Not Disturb feature

DTMF (Dual-Tone Multi-Frequency): Telephone tones commonly known as "touch-tone"

Emergency Bypass Port: The fifth SB67010 PSTN Gateway jack that can provide telephone operation during a power failure when used with an analog phone

Ethernet: A type of computer networking technology that connects devices via Local Area Networks (LANs)

Extension Directory: A private list of names and phone numbers available to only a single extension (referred to as "Personal list" on the Deskset)

Extension list: A list of names and extension numbers for the Synapse system telephones

extension number: The three-digit or four-digit number representing each individual Deskset

factory default: The original product settings

flash memory: Reprogrammable system storage used for storing software upgrades

FWD ON (FWD ON): An indicator in the top right corner of the Deskset display that appears when the Call Forward feature has been turned on. This feature causes calls to that extension number to be automatically forwarded to another extension, outside phone number, or to Voicemail.

FXO (Foreign Exchange Office): The Gateway telephone signaling interface between the PSTN telephone lines and the LAN

FXS station port: A jack on the ATA for connecting non-Synapse analog telephone equipment to the Synapse system

Gateway: A network device equipped for interfacing with another network that uses different protocols

greeting, preset: The voice message that plays to callers if the user has not recorded an outgoing message



grounding: An electrical ground connection that minimizes interference, reduces the risk of equipment damage due to lightning, eliminates electrostatic buildup, and helps protect people who service the equipment

Group Mailbox: Provide general delivery of Voicemail messages to a group within an organization. Only subscribers can access these Voicemail messages.

hard key: Any physical key on the Deskset, Cordless Handset or Gateway. Examples include **MENU** and **1** on the Deskset; and **SELECT** and **CANCEL** on the Gateway.

hard reset: An action that restores factory default settings

Hold announcement: A recorded message to play while calls are on hold. It can be combined with music on hold.

hunt group: A telephone company feature that allows calls to a busy phone number to roll over to the next available line or a Synapse system ring group feature where unanswered calls are forwarded to the next available extension in a predefined group of extensions

icon: A small picture in the display that presents status information

Idle: The mode of a device when it is not involved in call or call setup activity

interference: Electrical signals close by that cause degraded audio performance for cordless devices

internal call: A phone call made from one of your Synapse system extensions to another extension

IP address (Internet Protocol address): An individual numeric identification assigned to devices on your LAN

ISDN (Integrated Services Digital Network): A set of communication standards for simultaneous digital transmission of voice, video, data, and other network services over the traditional circuits of the public switched telephone network.

key beep: When enabled, pressing a key plays a tone

LAN (Local Area Network): A communications network that allows data devices to communicate with each other

LCD (Liquid Crystal Display): The screen that provides instructions and feedback

LED (Light Emitting Diode): A small light on a device that indicates status

live dial: Dialing after the phone is off hook

main menu, Auto Attendant: The Auto Attendant messages and actions that are available to callers before the callers take additional actions

MoH (Music on Hold): Music or other audio that plays to an outside caller that has been put on hold by a Synapse user

multi-zone paging: Paging through a multi-zone overhead paging system. The overhead loudspeakers are configured in multiple areas and transmit messages independently.

mute: Stop sending your voice to the other party during a phone call

NTP (Network Time Protocol): An Internet standard protocol that assures time synchronization in a computer network



off hook: Indicates that you are on a phone call, have lifted the corded handset, or have pressed **SPEAKER** or **HEADSET** to answer a call or to prepare to make a call. You are off hook from the moment that you hear a dial tone to when you hang up a call.

OHP (overhead paging) system: An amplified public address system

on hook: Indicates that no corded handset, speakerphone, Cordless Handset, or corded or Cordless Headset is active

operator: The extension that callers reach by dialing **0** (zero) when the Auto Attendant operator feature is enabled or that system users reach at any time by dialing **0** (zero)

outside call: A phone call between a phone not a part of your Synapse system and an extension within your Synapse system

page: Broadcasts your voice to all idle extensions that do not have Do Not Disturb turned on

paging zone: A set of extensions that can be paged as a group

park: A form of hold that allows held calls to be retrieved by any Deskset or Cordless Handset

Park list: The list of unretrieved parked calls

Personal list: A private list of names and phone numbers available to only a single extension (referred to as "Extension Directory" on the WebUI)

Pilot Number: Usually the company's main telephone number

POTS (Plain Old Telephone Service): Basic telephone operation. The ability to make and receive phone calls.

predial: Enter digits before going off hook to make a call

PSTN (Public Switched Telephone Network): The world's telephone network

Quick Dial: Provides two-touch dialing for frequently called phone numbers

quota: The maximum recording time for a Group Mailbox

reboot: Restart a device

Redial: Accesses the log of outgoing calls

Remote site: A Synapse site in another location that is linked to your office through a SIP Gateway. You can call remote Desksets by dialing their extension number. You can also make long-distance calls through a remote site as if you were dialing a local call. Depending on your system configuration, you may need to dial a prefix such as 9 to make Remote Site calls. Consult your system administrator.

RF (radio frequency): The communication channel for most Cordless Handsets and Cordless Headsets

ring group: Groups of extensions configured by the system administrator to all ring in a predetermined pattern within the group when calls come in for that group

router: An electronic device that connects two or more other electronic devices to each other, allowing them to communicate

single-zone paging: Paging to a single set of overhead loudspeakers. All speakers transmit the same announcement simultaneously.



SIP: Session Initiation Protocol, a signaling protocol used for voice and video communications over the Internet

soft key: The Synapse Desksets and Cordless Handsets feature keys below the LCD screen. The bottom of the LCD displays the appropriate label for each key as the function of the key changes.

standby time: The amount of time that a Cordless Handset or Cordless Headset can sit idle out of its charger while still capable of operating normally

subscriber: A user who can access messages in a Group Mailbox

supervised transfer: Occurs when you communicate with the transfer recipient before completing a transferred call

switch: A network switch links electronic devices. The switch processes and routes data flexibly, allowing more data to be handled without error.

system administrator: A person to perform functions such as setting up and modifying system configurations. This system administrator can be an employee or your telephone equipment provider.

System Directory: (see System list)

System list: This list of names and phone numbers is created and maintained by the system administrator. All system users can sort and view this list.

system operator: The extension that callers reach by dialing **0** (zero) when the Auto Attendant operator feature is enabled or that system users reach at any time by dialing **0** (zero)

T1: A digital signaling standard to transmit voice and data between devices

trunk: A communications connection between the Synapse system and the telephone company

unsupervised transfer: Occurs when you do not communicate with the transfer recipient when transferring calls. The transfer recipient does not have to pick up the phone and talk to you before receiving the transferred call.

VoIP (Voice over Internet Protocol): A transmission technology for delivery of voice communications over IP networks such as the Internet or other packet-switched networks. Other synonymous terms include IP telephony, Internet telephony, Voice Over BroadBand (VoBB), broadband telephony, and broadband phone.

WebUI (Web User Interface): A means of interacting with a product using a computer interface. Connection to the World Wide Web is not necessary.

