



at&t

User's manual

EL51200/EL51210/EL51250

DECT 6.0 cordless telephone
with caller ID/call waiting



Congratulations

on purchasing your new AT&T product. Before using this AT&T product, please read **Important safety information** on page 53 of this user's manual. Please thoroughly read the user's manual for all the feature operations and troubleshooting information you need to install and operate your new AT&T product. You can also visit our website at **www.telephones.att.com** or call **1 (800) 222-3111**. In Canada, dial **1 (866) 288-4268**.

Model number: EL51200 (two-handset system)
EL51210 (two-handset system)
EL51250 (two-handset system)

Type: DECT 6.0 cordless telephone

Serial number: _____

Purchase date: _____

Place of purchase: _____

Both the model and serial number of your AT&T product can be found on the bottom of the telephone base.



Telephones identified with this logo have reduced noise and interference when used with most T-coil equipped hearing aids and cochlear implants. The TIA-1083 Compliant Logo is a trademark of the Telecommunications Industry Association. Used under license.



The ENERGY STAR® program (www.energystar.gov) recognizes and encourages the use of products that save energy and help protect our environment. We are proud to mark this product with the ENERGY STAR® label indicating it meets the latest energy efficiency guidelines.

Parts checklist

Your telephone package contains the following items. Save your sales receipt and original packaging in the event warranty service is necessary.



Quick start guide



Telephone base

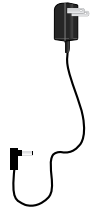

Power adapter for telephone base



Cordless handset
(2 for EL51200, EL51210 or
EL51250)

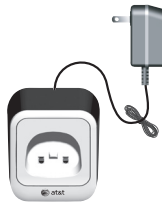

Charger for cordless handset
with power adapter installed
(1 for EL51200, EL51210 or
EL51250)

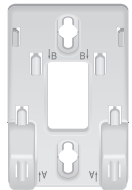

Wall mount bracket



Battery for cordless handset
(2 for EL51200, EL51210 or
EL51250)



Battery compartment cover
(2 for EL51200, EL51210 or
EL51250)



Telephone line cord

User's manual

EL51200/EL51210/EL51250
DECT 6.0 cordless telephone
with caller ID/call waiting



Table of contents

Getting started

Quick reference guide	2
Telephone base and charger installation.....	4
Battery installation and charging.....	5
Battery installation.....	5
Battery charging.....	6
Wall mount installation.....	7
Tabletop to wall mount installation.....	7
Wall mount to tabletop installation	9

Telephone settings

Menu overview.....	10
Handset settings.....	11
Ringer volume.....	11
Ringer tone.....	11
LCD language.....	12
Voicemail waiting (visual message waiting) indicator	12
Clear voicemail indication	12
Key tone.....	13
Set date/time.....	13
Home area code	14
Dial mode.....	14

Telephone operation

Making, answering and ending a call.....	15
Making a call	15
Temporary ringer silencing.....	15
Answering a call.....	16

Speakerphone.....	16
Ending a call.....	16
Redial.....	17
To review numbers in the redial list.....	17
To call a number from the redial list.....	17
To copy a number from the redial list to the directory.....	18
To delete a number in the redial list.....	18
Options while on calls.....	19
Volume control.....	19
Mute.....	19
Flash/call waiting	19
Temporary tone dialing.....	20
Chain dialing.....	20
Join a call in process.....	21
Handset locator.....	22
Intercom.....	23
To make and answer an intercom call.....	23
To answer an incoming call during an intercom call.....	23
Call transfer using intercom.....	24

Directory

Directory overview.....	25
Shared directory.....	25
Directory memory capacity.....	25
Exiting the directory	25
Speed dial overview.....	25

Create directory entries.....	26
To create a new directory entry.....	26
To add a predialed telephone number to the directory.....	27
Reviewing the directory.....	28
To review directory entries.....	28
To search by name.....	28
Dialing, deleting and editing a directory entry.....	30
To dial a directory number.....	30
To delete a directory entry.....	30
To edit a directory entry.....	30
Speed dial locations.....	31
To assign or reassign a directory entry to a speed dial location.....	31
To clear a speed dial location.....	32
To dial a speed dial number.....	32
Caller ID	
About caller ID.....	33
Information about caller ID with call waiting.....	33
About home area code.....	33
Caller ID history.....	34
How caller ID history (call log) works.....	34
Memory match.....	34
Caller ID operation.....	35
Missed (new) calls indicator.....	35
Reasons for missing caller ID information.....	35
To review the caller ID history.....	36
To view the dialing options.....	37
To dial a number from the caller ID history.....	37
To delete caller ID history entries.....	38
Saving a caller ID history entry in the directory.....	38

Appendix

Screen icons, indicator lights and alert tones.....	40
Screen icons.....	40
Handset indicator lights.....	40
Telephone base indicator lights.....	41
Handset alert tones.....	41
Handset display screen messages.....	42
Troubleshooting.....	44
Maintenance.....	52
Important safety information.....	53
Safety information.....	53
Especially about cordless telephones.....	53
Precautions for users of implanted cardiac pacemakers.....	54
Pacemaker patients.....	54
Especially about telephone answering systems.....	54
FCC Part 68 and ACTA.....	55
FCC Part 15.....	57
Limited warranty.....	58
Technical specifications.....	61
DECT 6.0 digital technology.....	61
Telephone operating range.....	61
Index	
Index.....	62

You must install and charge the battery before using the cordless handset.



See pages 5 and 6 for easy instructions.

Install the telephone base close to a telephone wall jack and an electrical outlet not controlled by a wall switch. The telephone base can be placed on a flat surface or vertically mounted on the wall (page 7). For optimum range and better reception, place the telephone base in a central and open location.

If you subscribe to high-speed Internet service (DSL - digital subscriber line) through your telephone line, you must install a DSL filter between the telephone line cord and the telephone wall jack (page 4). The filter prevents noise and caller ID problems caused by DSL interference. Please contact your DSL service provider for more information about DSL filters.

Your product may be shipped with a protective sticker covering the handset or telephone base display - remove it before use.

For customer service or product information, visit our website at **www.telephones.att.com** or call **1 (800) 222-3111**. In Canada, dial **1 (866) 288-4268**.

Avoid placing the telephone base too close to:

- Communication devices such as: television sets, VCRs, or other cordless telephones.
- Excessive heat sources.
- Noise sources such as a window with traffic outside, motors, microwave ovens, refrigerators, or fluorescent lighting.
- Excessive dust sources such as a workshop or garage.
- Excessive moisture.
- Extremely low temperature.
- Mechanical vibration or shock such as on top of a washing machine or work bench.

Quick reference guide

REDIAL/PAUSE

Press repeatedly to view the last 20 numbers dialed (page 17).
While entering numbers, press and hold to insert a dialing pause (pages 15 and 26).

PHONE/FLASH

Press to make or answer a call (page 15).
During a call, press to answer an incoming call when you receive a call waiting alert (page 19).

1

While reviewing a caller ID history entry, press repeatedly to add or remove 1 in front of the telephone number before dialing or saving it in the directory (page 37).

0

While entering names in the directory, press to add a space (page 26).

TONE ✕

During a call, press to send touch-tone signals (page 20).

SPEAKER

Press to turn on the handset speakerphone. Press again to resume normal handset use (page 16).

MUTE/DELETE

During a call, press to mute the microphone (page 19).
While predialing, press to delete digits (page 15).
While reviewing the redial list, directory, speed dial list or caller ID history, press to delete an individual entry (pages 18, 30, 31 and 38).

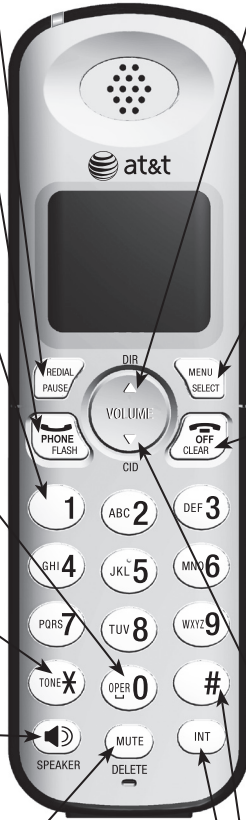

▲DIR/VOLUME

Press to scroll up while in menus (page 10).
Press to increase the listening volume (page 19).
Press to show directory entries when the handset is not in use (page 28).
While entering names or numbers in the directory, press to move the cursor to the right (page 26).

MENU/SELECT

Press to display the menu (page 10).
Once in the menu, press to select an item or save an entry or setting (page 10).

OFF/CLEAR

During a call, press to hang up (page 16).
While using menus, press to cancel an operation, back up to the previous menu, or exit the menu display (page 10).
Press and hold while the handset is not in use to erase the missed calls indicator (page 35).

▼CID/VOLUME

Press to scroll down while in menus (page 10).
Press to decrease the listening volume (page 19).
Press to show the caller ID history when the handset is not in use (page 36).
While entering names or numbers in the directory, press to move the cursor to the left (page 26).

#

When reviewing a caller ID history entry, press repeatedly to view the dialing options (page 37).

INT

Press to initiate an intercom conversation or transfer a call (pages 23 and 24).

Quick reference guide

The > symbol indicates the feature to select.



Main menu

- DIRECTORY (page 26)
- CALL LOG (page 36)
- RINGERS (page 11)
- SETTINGS (pages 12-14)

Using menus

Press **MENU/SELECT** to enter the main menu.

Press **▲DIR** or **▼CID** to scroll through menu items.

Press **MENU/SELECT** to select or modify a highlighted item.

Press **☎OFF/CLEAR** to cancel an operation, back up to the previous menu, or exit the menu display.



HANDSET LOCATOR

Press to make the handsets beep so you can locate them (page 22).

Telephone base and charger installation

If you subscribe to high-speed Internet service (DSL - digital subscriber line) through your telephone line, you must install a DSL filter between the telephone line cord and the telephone wall jack. The filter prevents noise and caller ID problems caused by DSL interference. Please contact your DSL service provider for more information about DSL filters.

The telephone base comes ready for tabletop use. If you want to mount your telephone on a wall, refer to **Wall mount installation** on page 7 for details.

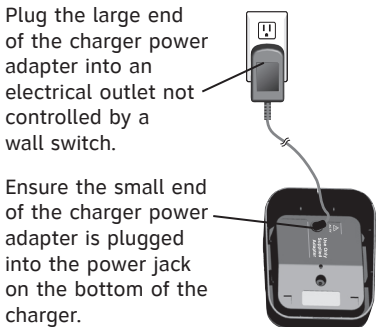
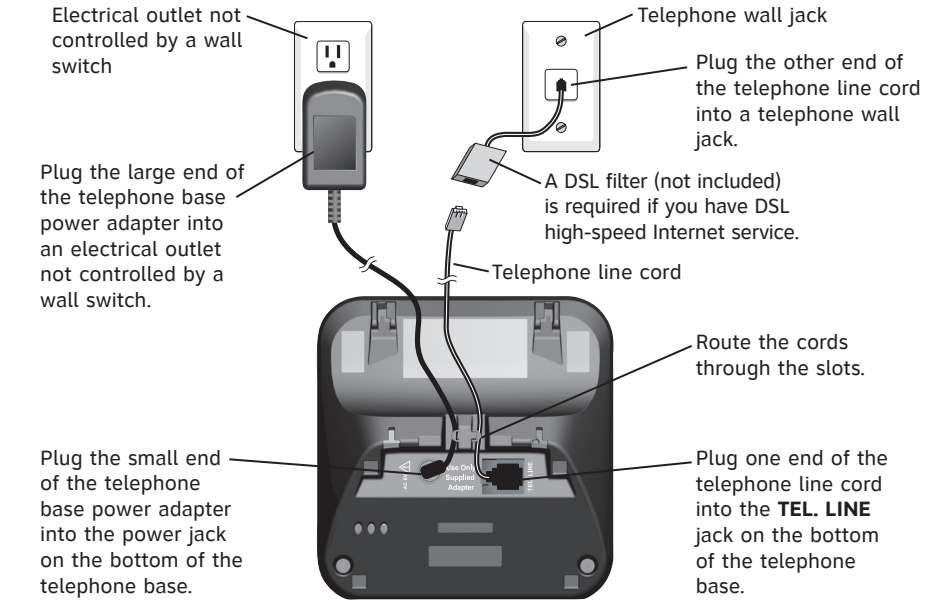

IMPORTANT INFORMATION:

Use only the power adapters provided with this product. To obtain a replacement, visit our website at www.telephones.att.com or call **1 (800) 222-3111**. In Canada, dial **1 (866) 288-4268**.

Battery installation and charging

Battery installation

Install the battery as shown below.

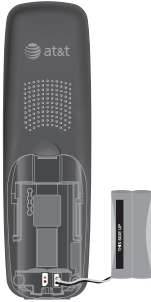

1. Plug the battery connector securely into the socket inside the handset battery compartment, matching the color-coded label.
2. Insert the supplied battery with the label **THIS SIDE UP** facing up as indicated.
3. Align the cover flat against the battery compartment, then slide it upwards until it clicks into place.



4. Charge the handset by placing it face up in the telephone base or charger. The **CHARGE** light is on when charging.



To replace the battery, press the tab and slide the battery compartment cover downwards. Lift out the old battery and disconnect it from the handset. Follow the instructions above to install and charge the new battery.

IMPORTANT INFORMATION:

Use only the supplied rechargeable battery or replacement battery (model BT166342). To order, visit our website at www.telephones.att.com, or call **1 (800) 222-3111**.

In Canada, dial **1 (866) 288-4268**.

Battery installation and charging





Battery charging

Once you have installed the battery, the screen indicates the battery status (see the table below). If necessary, place the handset in the telephone base or charger to charge the battery. For best performance, keep the handset in the telephone base or charger when not in use. The battery is fully charged after 16 hours of continuous charging. See **Technical specifications** on page 61 for battery operating times.



Battery status icon

If the screen is blank, you need to charge the handset without interruption for at least 30 minutes to give the handset enough charge to use the telephone for a short time. The screen shows **LOW BATTERY** until you have charged the battery without interruption for at least 30 minutes. The following table summarizes the battery charge indicators and actions to take.

Battery indicators	Battery status	Action
The screen is blank or shows PLACE IN CHARGER .	Battery has no or very little charge. The handset cannot be used.	Charge without interruption until the screen shows LOW BATTERY or HANDSET X (at least 30 minutes).
The screen shows LOW BATTERY and  flashes.	Battery has enough charge to be used for a short time.	Charge without interruption until the screen shows HANDSET X (at least 30 minutes).
The screen shows HANDSET X and the battery icon shows  ,  or  .	Battery is charged.	To keep the battery charged, place it in the telephone base or charger when not in use.

NOTES:

- If you are on a call in low battery mode, you hear four short beeps every 50 seconds.
- When you place the handset in the telephone base or charger, if no battery is installed in that handset, the **CHARGE** light is off and the screen shows **NO BATTERY**. Follow the instructions in **Battery installation** on page 5 to install the battery.

Wall mount installation

The telephone base comes ready for tabletop use. If you want to mount your telephone on a wall, use the provided wall mount bracket to connect with a standard dual-stud telephone wall mounting plate. If you do not have this mounting plate, you can purchase one from many hardware or consumer electronics retailers. Professional assistance may be required to install the mounting plate.

Tabletop to wall mount installation

To change the telephone base from the tabletop installation to wall mount installation, make sure you first unplug the power adapter from the electrical outlet and unplug the telephone line cord from the telephone wall jack.

1. Plug one end of the telephone line cord into the **TEL. LINE** jack on the bottom of the telephone base. Plug the small end of the base power adapter into the power jack on the bottom of the telephone base.
2. Position the telephone base as shown below. Insert the extended tabs of the wall mount bracket into the slots on the back of the telephone base. Push the telephone base down until it clicks securely in place.
3. Route the telephone line cord through the wall mount bracket hole. Route the power cord out of the bottom of the telephone.

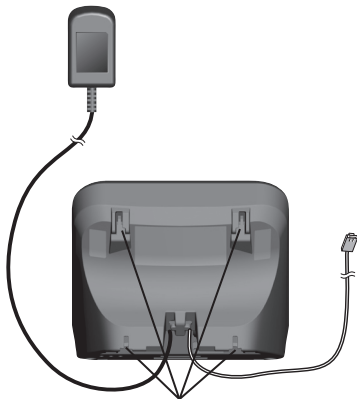

Slots for wall mount bracket installation



A DSL filter (not included) is required if you have DSL high-speed Internet service.

Wall mount installation

4. Plug the other end of the telephone line cord into the telephone wall jack. Plug the large end of the base power adapter into an electrical outlet not controlled by a wall switch.

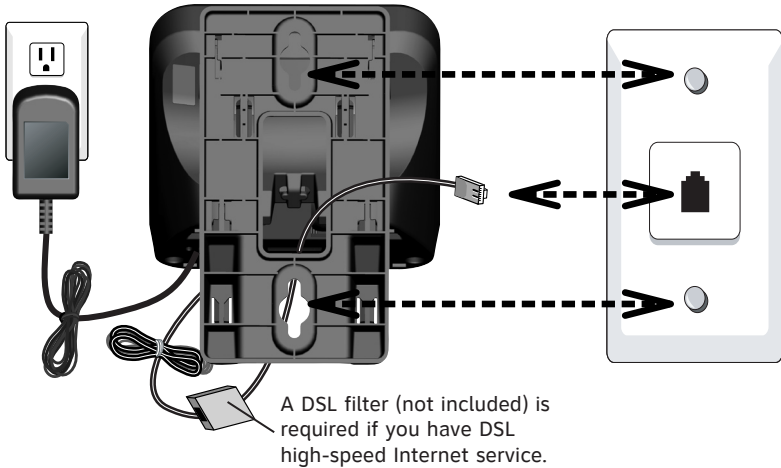

5. Align the holes on the wall mount bracket with the mounting studs of the wall mounting plate and slide the bracket down until it locks securely. Bundle the telephone line cord and power adapter cord neatly with twist ties.

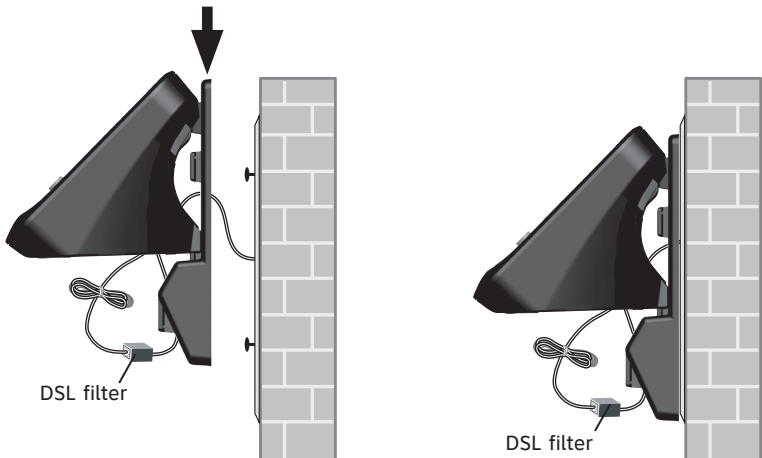

Wall mount installation

Wall mount to tabletop installation

To change the telephone base from the wall mount installation to tabletop installation, follow the steps below.

1. Unplug the large end of the base power adapter from the electrical outlet.
2. If the telephone line cord and power adapter cord are bundled, untie them first. Slide the wall mount bracket up and remove it from the wall mounting plate. Unplug the end of the telephone line cord from the telephone wall jack.

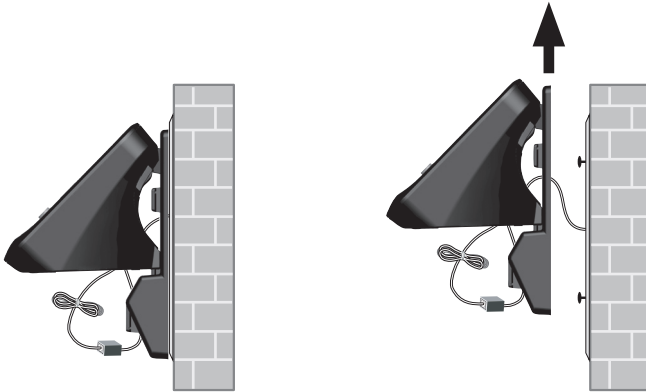

3. Lift the telephone base up to detach it from the wall mount bracket.



4. Refer to **Telephone base and charger installation** on page 4 to install the telephone base.

Menu overview

Use the menu to change the telephone settings.

1. Press **MENU/SELECT** in idle mode (when the handset is not in use) to enter the main menu.
2. Press **▲DIR** or **▼CID** to scroll until the **>** symbol is next to the feature you want to select.
3. Press **MENU/SELECT** to select or save the indicated item.



The handset is in idle mode.



The > symbol indicates the feature to select.

-OR-
Press **OFF/CLEAR** to cancel an operation, back up to the previous menu or exit the menu display.

-OR-
Press and hold **OFF/CLEAR** to cancel an operation and return to idle mode.

-OR-
If no key is pressed within 30 seconds, the handset automatically cancels an operation and returns to idle mode.

i **NOTE:** The menu items **DIRECTORY**, **CALL LOG**, **CLR VOICEMAIL**, **SET DATE/TIME**, **HOME AREA CODE** and **DIAL MODE** are shared by all handsets. Any changes made to these menu items on any one handset apply to all.

Menu structure

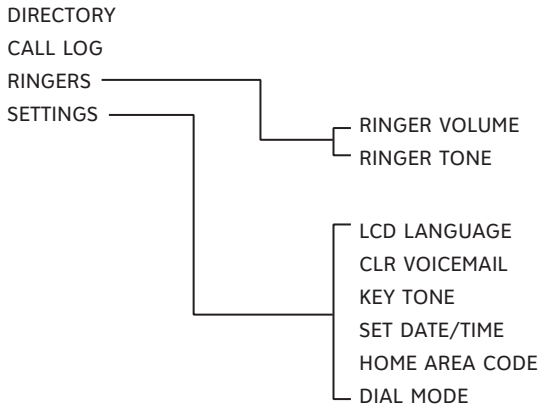

Handset settings

Ringer volume

You can set the handset ringer volume level (1-6), or turn the ringer off. When the ringer is off,  appears on the handset screen.

1. Press **MENU/SELECT** in idle mode to enter the main menu.
2. Press **▲DIR** or **▼CID** to scroll to **>RINGERS**. Press **MENU/SELECT**.
3. Press **MENU/SELECT** to select **>RINGER VOLUME**.
4. Press **▲DIR** or **▼CID** to sample each volume level.
5. Press **MENU/SELECT** to save your preference.

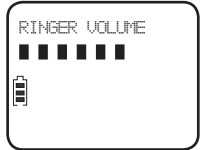

NOTES:

- The handset ringer volume also determines the ringer volume of intercom calls (see **Intercom** on page 23).
- If the handset ringer volume is set to off, that handset ringer is silenced for all incoming calls; however, that handset still plays the paging tone when initiating the handset locator feature (see **Handset locator** on page 22).
- While the telephone is ringing, pressing **☎OFF/CLEAR** or **MUTE/DELETE** silences the ringer temporarily (see **Temporary ringer silencing** on page 15).

Ringer tone

You can choose one of 10 ringer tones for the handset.

1. Follow steps 1 and 2 in **Ringer volume** on this page.
2. Press **▲DIR** or **▼CID** to scroll to **>RINGER TONE**, then press **MENU/SELECT**.
3. Press **▲DIR** or **▼CID** to sample each ringer tone.
4. Press **MENU/SELECT** to save your preference.

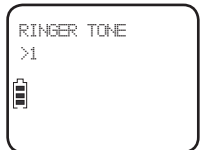

 **NOTE:** If you turn off the ringer volume, you will not hear ringer tone samples.

Handset settings

LCD language

You can use this feature to select the language used for all screen displays.

1. Press **MENU/SELECT** in idle mode to enter the main menu.
2. Press **▲DIR** or **▼CID** to scroll to **>SETTINGS**.
3. Press **MENU/SELECT** twice to select **>LCD LANGUAGE**.
4. Press **▲DIR** or **▼CID** to select **ENGLISH, FRANÇAIS** or **ESPAÑOL**.
5. Press **MENU/SELECT** to save your preference.

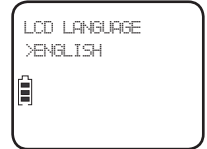

Voicemail waiting (visual message waiting) indicator

If you subscribe to a voicemail service offered by your telephone service provider, this feature provides a visual indication when you have new voicemail messages. **NEW VOICEMAIL** and  appear on the handset screen.



 **NOTE:** Your telephone service provider might alert you to new voicemail messages with a stutter (broken) dial tone. Contact your telephone service provider for more details.

Clear voicemail indication

Use this feature when the telephone indicates there is new voicemail but there is none. This may occur, for example, when you have accessed your voicemail while away from home. This feature only turns off the displayed **NEW VOICEMAIL** message and  icon; it does not delete your voicemail messages. As long as you have new voicemail messages, your telephone service provider continues to send the signal to turn on the indicator.

To manually turn off the new voicemail indicator:

1. Follow steps 1 and 2 in **LCD language** on this page.
2. Press **▲DIR** or **▼CID** to scroll to **>CLR VOICEMAIL**, then press **MENU/SELECT**. The screen shows **TURN OFF INDICATOR?**
3. Press **MENU/SELECT** to turn the voicemail indication off. A confirmation tone sounds.



-OR-

Press **OFF/CLEAR** to cancel the procedure.

 **NOTE:** For information about using your voicemail service, contact your telephone service provider.

Handset settings

Key tone

The handset is programmed to beep with each key press. You can turn **KEY TONE** off, so there are no beeps when you press keys.

1. Press **MENU/SELECT** in idle mode to enter the main menu.
2. Press **▲DIR** or **▼CID** to scroll to **>SETTINGS**, then press **MENU/SELECT**.
3. Press **▲DIR** or **▼CID** to scroll to **>KEY TONE**, then press **MENU/SELECT**.
4. Press **▲DIR** or **▼CID** to select **ON** or **OFF**.
5. Press **MENU/SELECT** to save your preference.

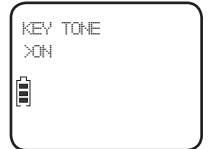

Set date/time

If you subscribe to caller ID service, the day, month and time are set automatically with each incoming call (see **About caller ID** on page 33).

To set the date and time manually:

1. Follow steps 1 and 2 in **Key tone** on this page.
2. Press **▲DIR** or **▼CID** to scroll to **>SET DATE/TIME**, then press **MENU/SELECT**.
3. Use the dial pad keys (0-9) to enter the two-digit number (01-12) for the month.
4. Use the dial pad keys (0-9) to enter the two-digit number (01-31) for the day.
5. Use the dial pad keys (0-9) to enter the two-digit number (00-99) for the year. Press **MENU/SELECT**.
6. Use the dial pad keys (0-9) to enter the two-digit number (01-12) for the hour.
7. Use the dial pad keys (0-9) to enter the two-digit number (00-59) for the minute.
8. Press **▲DIR** or **▼CID** to choose **AM** or **PM**. Press **MENU/SELECT** to confirm. A confirmation tone sounds.

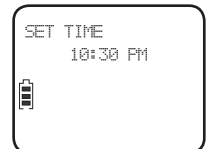
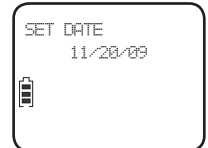

Handset settings

Home area code

If you dial seven digits to make a local call (no area code required), enter your area code into the telephone as the home area code. When you receive a call from within your home area code, the caller ID history only displays the seven digits of the telephone number.

This feature makes it easy for you to place a call from the caller ID history. If you dial 10 digits to make a local telephone call, do not use this home area code feature. If you do, you will not be able to place calls from your caller ID history as they have only seven digits.

1. Press **MENU/SELECT** in idle mode to enter the main menu.
2. Press **▲DIR** or **▼CID** to scroll to **>SETTINGS**, then press **MENU/SELECT**.
3. Press **▲DIR** or **▼CID** to scroll to **>HOME AREA CODE**, then press **MENU/SELECT**.
4. Press the dial pad keys to enter your three-digit area code. Press **MUTE/DELETE** to delete digits while entering.
5. Press **MENU/SELECT** to save the setting.

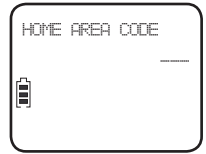

i NOTE: If, in the future, your telephone service provider requires you to dial 10 digits to make a local call (area code + telephone number), you will need to delete your home area code. While the home area code displaying in step 4 above, press and hold **MUTE/DELETE**. The home area code is now restored to its default setting of **___** (empty).

Dial mode

The dial mode is preset to tone dialing. If you have pulse (rotary) service, you must change the dial mode to pulse dialing before using the telephone.

1. Follow steps 1 and 2 in **Home area code** on this page.
2. Press **▲DIR** or **▼CID** to scroll to **>DIAL MODE**, then press **MENU/SELECT**.
3. Press **▲DIR** or **▼CID** to select **TONE** or **PULSE**.
4. Press **MENU/SELECT** to save the setting.

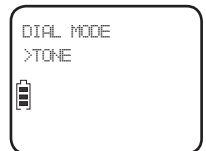

i NOTE: If you have pulse (rotary) dialing service only, refer to **Temporary tone dialing** on page 20 to temporarily switch from pulse to touch-tone dialing during a call.

Making, answering and ending a call

Making a call

To make a call:

1. Press **PHONE/FLASH**, then wait for the dial tone.
-OR-
Press **SPEAKER** to use the speakerphone, then wait for the dial tone.
2. Use the dial pad keys to enter the telephone number.

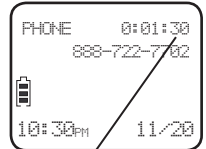

The screen displays the elapsed time as you talk (in hours, minutes and seconds).

On-hook dialing (predialing):

1. Use the dial pad keys to enter the telephone number (up to 30 digits).
 - Press and hold **REDIAL/PAUSE** to insert a three-second dialing pause (a **P** appears).
 - Press **MUTE/DELETE** or **OFF/CLEAR** to make corrections.
2. Press **PHONE/FLASH** to call.
-OR-
Press **SPEAKER** to call using the speakerphone.
-OR-
Press and hold **OFF/CLEAR** to return to idle mode.

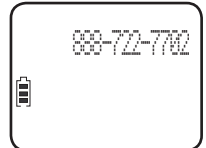

NOTES:

- Pressing **PHONE/FLASH** to access services from your telephone service provider does not affect the elapsed time.
- When a handset is on a call, if another handset attempts to access the directory, speed dial list or caller ID history, the screen shows **NOT AVAILABLE AT THIS TIME**.

Temporary ringer silencing

While the telephone is ringing, press **OFF/CLEAR** or **MUTE/DELETE** to silence the ringer temporarily on that handset only.

This turns off the ringer without disconnecting the call. The next incoming call rings normally at the preset volume.



NOTE: Unless the ringer volume is turned off on that handset, each handset rings when there is an incoming call.

Making, answering and ending a call

Answering a call

- Press any dial pad key (known as Any Key Answer) or **PHONE/FLASH**.

-OR-

- Press **SPEAKER** to use the speakerphone.

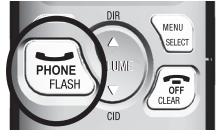

Speakerphone

During a call, press **SPEAKER** to switch between speakerphone and normal handset use.

Press **OFF/CLEAR** to hang up.

- **NOTE:** After installing the battery in the handset, the screen may show **LOW BATTERY**. If you use the speakerphone at this time, the battery may become depleted. Follow the instructions in **Battery charging** on page 6.



Ending a call

- Press **OFF/CLEAR**.

-OR-

- Put the handset in the telephone base or charger to end the call (known as Auto Off).

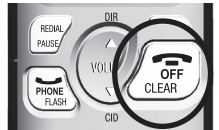

Redial

Each handset stores the 20 numbers most recently called in the redial list.

To review numbers in the redial list

1. Press **REDIAL/PAUSE** in idle mode.
2. Press **▲DIR** or **▼CID**, or Press **REDIAL/PAUSE** repeatedly to scroll through the 20 recently called numbers (up to 30 digits each). The handset beeps twice at the beginning or end of the list.
3. Press **☎OFF/CLEAR** to exit the redial list.

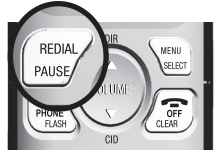

i NOTE: If you try to access an empty redial list, the handset sounds an error tone.

To call a number from the redial list

1. With the desired number from redial displaying, press **☎PHONE/FLASH** or **🔊SPEAKER** to dial (known as Display Dial).

-OR-

1. Press **☎PHONE/FLASH** or **🔊SPEAKER** and then wait for the dial tone.
2. Press **REDIAL/PAUSE**. The screen shows the number most recently called. If it is not the desired number, press **▲DIR** or **▼CID** to scroll to the desired one.
3. Press **MENU/SELECT**. The handset dials the displayed number.

i NOTE: If you access an empty redial list, the handset sounds an error tone.

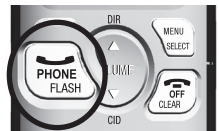

Redial

To copy a number from the redial list to the directory

1. While reviewing the desired number in the redial list, press **MENU/SELECT** twice to edit the telephone number. Refer to step 5 in **To create a new directory entry** on page 26.
2. Press **MENU/SELECT** to add the name. Refer to step 7 in **To create a new directory entry** on page 26.
3. Press **MENU/SELECT** to store your new directory entry. The handset shows **SAVED** and sounds a confirmation tone.



To delete a number in the redial list

- While reviewing a number in the redial list, press **MUTE/DELETE** to delete the displayed number from the redial list.



Options while on calls

Volume control

While on a call, press **▲DIR/VOLUME** to increase or press **▼CID/VOLUME** to decrease the listening volume.

When the volume reaches the minimum or maximum setting, you hear two beeps.

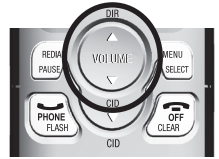

i NOTE: The handset earpiece volume setting (1-5) and speakerphone volume setting (1-6) are independent.

Mute

Use the mute function to turn off the microphone while on a call. You can hear the caller, but the caller does not hear you.

To mute the call:

- Press **MUTE/DELETE**. When mute is on, the handset screen shows **MUTED** for a few seconds and the **MUTE** icon appears until you turn off mute.



To end mute:

- Press **MUTE/DELETE** and then resume speaking. When mute is off, **MICROPHONE ON** appears temporarily on the handset screen.

-OR-

Mute is automatically canceled when you end the call.

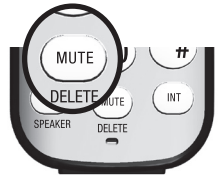

Flash/call waiting

For more information about caller ID with call waiting, refer to **About caller ID** on page 33. If you subscribe to call waiting service provided by your telephone service provider, you hear a beep if someone calls you while you are already on a call.

- Press **☎PHONE/FLASH** to put your current call on hold and take the new call.
- Press **☎PHONE/FLASH** anytime to switch back and forth between calls.

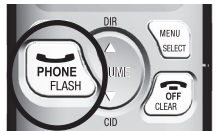

Options while on calls

Temporary tone dialing

If you have pulse (rotary) dialing service only, use this feature to temporarily switch from pulse to touch-tone dialing during a call.

1. During a call, press **TONE✕**. Buttons pressed after this send touch-tone signals.
2. Use the dial pad keys to enter the number.
3. The telephone automatically returns to pulse dial mode after you end the call.

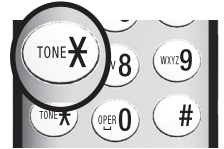

Chain dialing

While on a call, you can initiate a dialing sequence from numbers stored in the directory, caller ID history or redial list. Doing this can be useful if you need to access numbers other than telephone numbers (such as bank account numbers or access codes).

• To access the directory while on a call:

1. Press **MENU/SELECT**.
2. Press **▲DIR** or **▼CID** to scroll to **>DIRECTORY**, then press **MENU/SELECT**.
3. Press **▲DIR** or **▼CID** to scroll or press the dial pad keys (0 through 9) to find the desired entry (see **To search by name** on page 28).
4. Press **MENU/SELECT**. The telephone automatically dials the displayed number.



• To access the caller ID history while on a call:

1. Press **MENU/SELECT**.
2. Press **▲DIR** or **▼CID** to scroll to **>CALL LOG**, then press **MENU/SELECT**.
3. Press **▲DIR** or **▼CID** to scroll to the desired entry. To view the dialing options, press **#** (see **To view the dialing options** on page 37).
4. Press **MENU/SELECT**. The telephone automatically dials the displayed number.

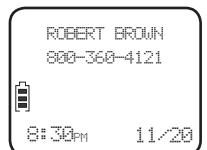

Options while on calls

• To access the redial list while on a call:

1. Press **REDIAL/PAUSE**. The screen shows the number most recently called. If it is not the desired number, press **▲DIR** or **▼CID** to scroll to the desired one.
2. Press **MENU/SELECT**. The handset dials the displayed number.



iNOTES:

- While on a call, you cannot edit a directory entry or copy a caller ID entry into the directory.
- If someone else is already using the directory, speed dial list, caller ID history or answering system, when you attempt to access one of them, the screen shows **NOT AVAILABLE AT THIS TIME**.
- Press **OFF/CLEAR** to exit the directory, caller ID history or redial list and return to the call without dialing the displayed number.

Join a call in process

If a handset is already on a call and you would like to join the call:

- Press **PHONE/FLASH** or **SPEAKER** on another system handset.

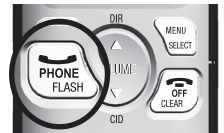

To exit the call:

- Press **OFF/CLEAR** or place the handset in the telephone base or charger.

The call does not end until all handsets hang up.

Handset locator

You can use the handset locator feature to find misplaced handsets.

To start the paging tone:

- Press **HANDSET LOCATOR** on the telephone base to start the paging tone on the handset for 60 seconds.

To stop the paging tone:

- Press **PHONE/FLASH**, **SPEAKER**, or any dial pad key (0-9, *, or #) on the handset.

-OR-

- Press **HANDSET LOCATOR** on the telephone base.

-OR-

- Put the handset in the telephone base or charger.

NOTES:

- If the handset is on a call or out of range, it does not beep when paged.
- If you press **OFF/CLEAR** or **MUTE/DELETE** on a handset, the ringer of that handset is silenced but the paging tone continues on the other handset.

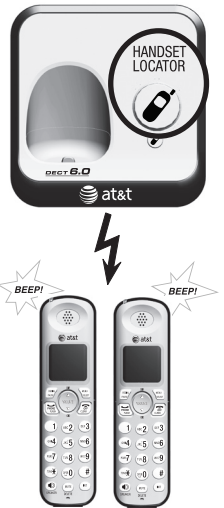

Intercom

To make and answer an intercom call

Use the intercom feature for conversations between handsets.

1. Press **INT** on your handset when not in use. Your handset screen shows **CALLING HANDSET X**. The other handset rings and its screen shows **HANDSET X IS CALLING**.
2. To answer the intercom call, press any dial pad key (0-9, *, or #), **PHONE/FLASH**, **SPEAKER** or **INT** on the other handset. Both handsets now show **INTERCOM**.
3. To end an intercom call, press **OFF/CLEAR** or place the handset back in the telephone base or charger. Both handsets now show **INTERCOM ENDED**.



NOTES:

- Before the intercom call is answered, you can cancel it by pressing **OFF/CLEAR** or **INT** on your originating handset.
- If the other handset is not answered within 100 seconds, is in use, on a call or is out of range, your originating handset shows **UNABLE TO CALL TRY AGAIN**.
- Pressing **OFF/CLEAR** or **MUTE/DELETE** temporarily silences the intercom ringer.

To answer an incoming call during an intercom call

If you receive an incoming outside call during an intercom call, there is an alert tone.

To answer the incoming outside call:

- Press **PHONE/FLASH**. The intercom call ends automatically.

To end the intercom call without answering the incoming outside call:

- Press **OFF/CLEAR**. The intercom call ends and the handsets ring for the incoming call.

Call transfer using intercom

Use the intercom feature to transfer an outside call to another system handset.

1. During a call, press **INT**. The outside call is put on hold. Your handset screen shows **CALLING HANDSET X**. The other handset rings and its screen shows **HANDSET X IS CALLING**.
2. To answer the intercom call on the other handset, press any dial pad key (0-9, *, or #), **PHONE/FLASH**, **SPEAKER** or **INT**. The outside call is still on hold and both handsets now show **INTERCOM**. You can now have a private conversation between the system handsets.

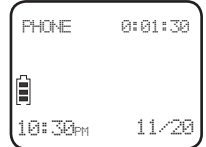

NOTES:

- To cancel the transfer and return to the external call before the intercom call is answered, press **OFF/CLEAR**, **PHONE/FLASH** or **INT** on your handset.
 - If the other handset is not answered within 100 seconds, is in use, on a call or is out of range, the calling handset shows **UNABLE TO CALL TRY AGAIN** on its screen and automatically returns to the external call.
3. From this intercom call, you have the following options:
 - You can let the other handset join you on the outside call in a three-way conversation. Press and hold INT on the calling handset.
 - You can transfer the call. Press **OFF/CLEAR**, or place your handset back in the telephone base or charger. Your handset screen shows **CALL TRANSFERRED**. The other handset automatically connects to the outside call.
 - You can switch between the outside call (**OUTSIDE CALL** appears on the screen) and the intercom call (**INTERCOM** appears on the screen). Press **INT** on your handset to switch.
 - The other person can end the intercom call by pressing **OFF/CLEAR**, or by placing the other handset back in the telephone base or charger. The outside call continues with the original system handset.



Directory overview

Shared directory

The directory is stored in the telephone base, and is shared by all handsets. Changes made to the directory on any one handset apply to all.



i **NOTE:** Only one handset can review the directory at a time. If another handset attempts to enter the directory, the screen shows **NOT AVAILABLE AT THIS TIME**.

Directory memory capacity

The directory can store up to 100 entries, with a maximum of 15 alphanumeric characters (including spaces) for the names and 30 digits for the telephone numbers. A convenient search feature can help you find and dial numbers quickly (see **To search by name** on page 28).

If there are already 100 entries, the screen shows **DIRECTORY FULL**. You cannot store a new number until you delete one.



If the directory is empty, when you access it, the screen shows **DIRECTORY EMPTY**.

Exiting the directory

Press **OFF/CLEAR** to cancel an operation, back up to the previous menu, or exit the menu display. Press and hold **OFF/CLEAR** to return to idle mode.

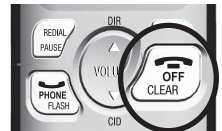

Speed dial overview

This telephone has 10 speed dial locations where you can assign telephone numbers from the directory you wish to dial numbers using only two key presses. For more details, refer to **Speed dial locations** on page 31.

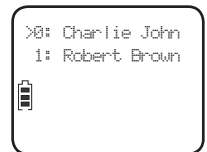

The speed dial locations are in the telephone base and are shared by all handsets. Changes made to the entries in the speed dial locations on any one handset apply to all.

i **NOTE:** Only one handset can access the speed dial locations at a time. If another handset attempts to access the speed dial locations, the screen shows **NOT AVAILABLE AT THIS TIME**.

Create directory entries

To create a new directory entry

1. Press **MENU/SELECT** in idle mode.
2. Press **▲DIR** or **▼CID** to scroll to **>DIRECTORY**, then press **MENU/SELECT**.
3. Press **▲DIR** or **▼CID** to scroll to **>ADD CONTACT**.
4. Press **MENU/SELECT**.
5. Enter the telephone number when prompted.



- Copy a number from redial:
 - a. Press **REDIAL/PAUSE**.
 - b. Press **▲DIR** or **▼CID** or press **REDIAL/PAUSE** repeatedly to locate the number to copy.
 - c. Press **MENU/SELECT** to copy the number.

-OR-

- Use the dial pad keys to enter a number (up to 30 digits).
 - Press **▲DIR** or **▼CID** to move the cursor to the right or left.
 - Press and hold **REDIAL/PAUSE** to enter a three-second dialing pause (a **P** appears).
 - Press **MUTE/DELETE** to erase digits.
 - Press and hold **MUTE/DELETE** to erase all digits.
6. Press **MENU/SELECT** to save the number in the display.
 7. Enter the name when prompted. Use the dial pad keys and refer to the character chart (page 27) to enter a name (up to 15 characters). Each time you press a key, the character on that key appears. Additional key presses produce other characters on that key.
 - Press **0** to add a space.
 - Press **▲DIR** or **▼CID** to move the cursor to the right or left.
 - Press **MUTE/DELETE** to erase characters.
 - Press and hold **MUTE/DELETE** to erase all characters.

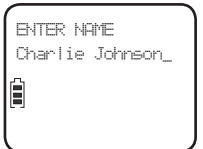

Create directory entries

- The first letter of every word is capitalized. The remaining letters in a word start as lower case letters as shown in the character chart below.

Dial Key	Characters by number of key presses										
	1	2	3	4	5	6	7	8	9	10	11
1	1	.	-	'	()	*	#	&	/	,
2	a	b	c	A	B	C	2				
3	d	e	f	D	E	F	3				
4	g	h	i	G	H	I	4				
5	j	k	l	J	K	L	5				
6	m	n	o	M	N	O	6				
7	p	q	r	s	P	Q	R	S	7		
8	t	u	v	T	U	V	8				
9	w	x	y	z	W	X	Y	Z	9		
0	space	0									

- Press **MENU/SELECT** to store your new directory entry. The handset shows **SAVED** and a confirmation tone sounds.

NOTES:

- The screen shows **NUMBER ALREADY SAVED** if the number is already in the directory. You cannot save the same number more than once.
- If you pause for too long while creating an entry, the procedure times out and you have to begin again.

To add a predialed telephone number to the directory

- While the handset is in idle mode, use the dial pad keys to enter the telephone number (up to 30 digits).
 - Press and hold **REDIAL/PAUSE** to insert a three-second dialing pause (a **P** appears).
 - Press **MUTE/DELETE** to make corrections.
- Press **MENU/SELECT** to edit the telephone number. Refer to step 5 in **To create a new directory entry** on page 26.
- Press **MENU/SELECT** to edit the name. Refer to step 7 in **To create a new directory entry** on page 26.
- Press **MENU/SELECT** to store your new directory entry. The handset shows **SAVED** and sounds a confirmation tone.

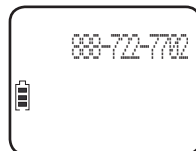

Reviewing the directory

To review directory entries

1. Press **▲DIR** when in idle mode to show the first entry in the directory. **DIRECTORY EMPTY** appears if there are no directory entries.

-OR-

You can also show the first entry in the directory by pressing **MENU/SELECT** when in idle mode. Press **▲DIR** or **▼CID** to scroll to **>DIRECTORY**, then press **MENU/SELECT** twice to select **>REVIEW**.

2. Press **▲DIR** or **▼CID** to browse through the directory. Entries appear alphabetically by the first letter in the name.



NOTES:

- If the telephone number in the directory exceeds 15 digits, <*> appears in front of the telephone number. Press **TONEx** to move towards the end of the telephone number or press **#** to move towards the beginning of the telephone number.
- If you pause for too long while reviewing an entry, the procedure times out and you have to begin again.

To search by name

1. Press **▲DIR** when in idle mode to show the first entry in the directory.
2. When an entry appears, press the dial pad keys (0-9) to start a name search (alphabetical search).

The directory shows the first name beginning with the first letter associated with the dial pad key if there is an entry in the directory that begins with that letter.

3. To see other names that start with the letters on the same dial pad key, keep pressing the key until the desired letter is shown. The names appear in alphabetical order.

For example, if you have the names Jennifer, Jessie, Kevin and Linda in your directory:

- If you press **5 (JKL)** once, **J** and then **Jennifer** display.
- If you press **5 (JKL)** once, **J** displays. Press **▼CID**. **Jessie** displays.

Reviewing the directory

- If you press **5 (JKL)** twice, **K** and then **Kevin** display.
- If you press **5 (JKL)** three times, **L** and then **Linda** display.
- If you press **5 (JKL)** four times, **5** displays.
- If you press **5 (JKL)** five times, **J** displays and then **Jennifer** displays again.



i **NOTE:** If you press a key (0-9) and no name starts with the letters on that key, the directory shows the entry that matches the next letter in the directory.

Dialing, deleting and editing a directory entry

You can dial, delete or edit the displayed directory entry.

See **To review directory entries** or **To search by name** on page 28 to show an entry from the directory first.



To dial a directory number

- While reviewing a directory entry, press **PHONE/FLASH** or **SPEAKER** to dial the displayed telephone number from the directory (known as Display Dial).

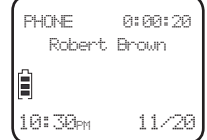

To delete a directory entry

1. While reviewing a directory entry, press **MUTE/DELETE**. The screen shows **DELETE CONTACT?**
2. Press **SELECT** to delete the displayed entry from the directory. The handset shows **DELETING...** and then **CONTACT DELETED** with a confirmation tone. Once deleted, you cannot retrieve that entry.
-OR-
Press **OFF/CLEAR** to exit and leave the entry intact.



NOTE: If the directory entry you deleted is also in the speed dial location, the telephone will automatically clear the speed dial location that entry occupied.

To edit a directory entry

1. While reviewing a directory entry, press **MENU/SELECT**. The screen shows **EDIT NUMBER** with the current number of the entry.
2. Follow step 5 in **To create a new directory entry** on page 26 to edit the digits.
3. Press **MENU/SELECT** to save the number in the display. The screen shows **EDIT NAME** with the current name of the entry.
4. Follow step 7 in **To create a new directory entry** on page 26 to edit the characters.
5. Press **MENU/SELECT** to confirm. The handset shows **SAVED** with a confirmation tone and then shows the updated entry.

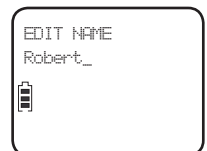
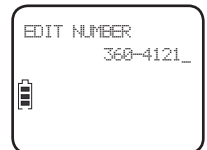

Speed dial locations

To assign or reassign a directory entry to a speed dial location

1. Press **MENU/SELECT** in idle mode.
2. Press **▲DIR** or **▼CID** to scroll to **>DIRECTORY**. Press **MENU/SELECT**.
3. Press **▲DIR** or **▼CID** to scroll to **>SPEED DIAL**. Press **MENU/SELECT**.
4. To assign a speed dial location, press **▲DIR** or **▼CID** to scroll to an empty speed dial location.
-OR-
 To reassign a speed dial location, press **▲DIR** or **▼CID** to scroll to the desired speed dial location.
5. Press **MENU/SELECT** to show the directory.
6. Press **▲DIR** or **▼CID** to browse through the directory and find the desired entry.
-OR-
 Use the alphabetical search to find the desired entry. Refer to steps 2 and 3 in **To search by name** on page 28.
7. Press **MENU/SELECT** to confirm. The name (up to 12 characters) of the desired directory entry appears in the selected speed dial location.

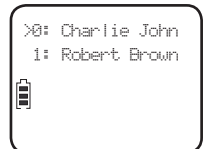
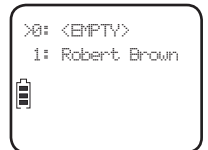
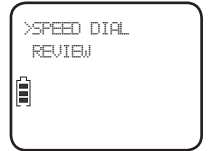

NOTES:

- If the directory is empty, when you press **MENU/SELECT** in step 5, the screen shows **DIRECTORY EMPTY**.
- If the speed dial location you selected is occupied, the new directory entry you selected replaces the old one. Take caution not to replace entries you do not wish to delete from the speed dial locations.

Speed dial locations

To clear a speed dial location

1. Press **MENU/SELECT** in idle mode.
2. Press **▲DIR** or **▼CID** to scroll to **>DIRECTORY**. Press **MENU/SELECT**.
3. Press **▲DIR** or **▼CID** to scroll to **>SPEED DIAL**. Press **MENU/SELECT**.
4. Press **▲DIR** or **▼CID** to scroll to a speed dial location.
5. Press **MUTE/DELETE** to clear the selected speed dial location. **<EMPTY>** appears in that speed dial location.

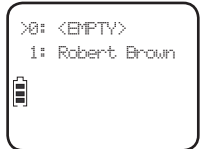
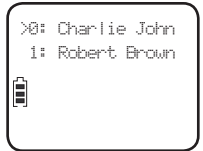

i **NOTE:** Clearing the speed dial locations does not affect the entries in the directory.

To dial a speed dial number

1. When in idle mode, press and hold a dial pad key (0 through 9) to choose the desired speed dial entry.
2. Press **PHONE/FLASH** or **SPEAKER** to dial the displayed telephone number (known as Display Dial).

i **NOTE:** If the speed dial location you selected is empty, the screen shows the speed dial list.



About caller ID

This product supports caller ID services offered by most telephone service providers. Caller ID allows you to see the name, number, date and time of calls. The available caller ID information will appear after the first or second ring.

Information about caller ID with call waiting

Caller ID with call waiting lets you see the name and telephone number of the caller before answering the call, even while on another call.

It may be necessary to change your telephone service to use this feature. Contact your telephone service provider if:

- You have both caller ID and call waiting, but as separate services (you may need to combine these services).
- You have only caller ID service, or only call waiting service.
- You don't subscribe to caller ID or call waiting services.

There are fees for caller ID services. In addition, services may not be available in all areas.

This product can provide information only if both you and the caller are in areas offering caller ID service and if both telephone service providers use compatible equipment. The time and date are sent by the telephone service provider along with the call information.

The caller ID information may not be available for every incoming call. The callers may intentionally block their names and/or telephone numbers.

iNOTE: You can use this product with regular caller ID service, or you can use this product's other features without subscribing to either caller ID or combined caller ID with call waiting service.

About home area code

See **Home area code** on page 14 to determine if you should enter your area code. Entering the area code changes how numbers are displayed in the caller ID history and how to return a call from the caller ID history (see **To view the dialing options** on page 37).



Caller ID history

How caller ID history (call log) works

The telephone stores caller ID information about the last 50 incoming calls in the telephone base. Each entry may have up to 24 digits for the telephone number and 15 characters for the name. Entries are stored in reverse chronological order. The telephone deletes the oldest entry when the log is full to make room for new calls. If you answer a call before the information appears on the screen, it does not show in the caller ID history.

i **NOTE:** The caller ID information might not be available for every incoming call. The callers might intentionally block their names and/or telephone numbers (see **Reasons for missing caller ID information** on page 35).

Memory match

If the incoming telephone number matches the last seven digits of a telephone number in your directory, the name that appears on the screen matches the corresponding name in your directory.

For example, if Christine Smith calls, her name appears as **Chris** if this is how you entered it into your directory.



i **NOTE:** The number shown by your caller ID is in the format sent by the telephone service provider. The telephone service provider usually delivers 10-digit telephone numbers (area code plus telephone number). If the telephone number of the caller does not match a number in your directory, the name appears as it is delivered by the telephone service provider. For example, if the telephone service provider includes the area code and the directory number does not, the name appears as delivered by the telephone service provider.

Caller ID operation

Missed (new) calls indicator

When you have calls that have not been reviewed, the handset idle screen shows **XX MISSED CALLS**.

All entries that have not been reviewed are counted as missed (new) calls. Each time you review a caller ID history entry marked **NEW**, the number of missed (new) calls decreases by one.

If you do not want to review the missed (new) calls one by one, but still want to keep them in the caller ID history, you can press and hold **↵OFF/CLEAR** for four seconds when the handset is idle. All the entries in the caller ID history are considered old (reviewed), and the missed calls message goes away.

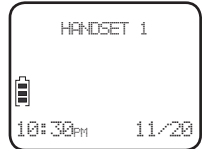
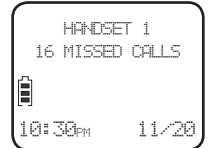

Reasons for missing caller ID information

There are occasions when other information or no information shows for various reasons:

Screen message	Reason
PRIVATE NAME	The caller prefers not to show the name.
PRIVATE NUMBER	The caller prefers not to show the telephone number.
PRIVATE CALLER	The caller prefers not to show the name and telephone number.
UNKNOWN NAME	Your telephone service provider cannot determine the caller's name.
UNKNOWN NUMBER	Your telephone service provider cannot determine the caller's telephone number.
UNKNOWN CALLER	Your telephone service provider cannot determine the caller's name and telephone number. Calls from other countries may also generate this message.

Caller ID operation

To review the caller ID history

Review the caller ID history to find out who called, to return the call or to copy the caller's name and number into your directory. **CALL LOG EMPTY** appears if there are no records in the caller ID history.

1. When a handset is in idle mode, press **▼CID** to review the caller ID history in reverse chronological order starting with the most recent call.

-OR-

You can also review the caller ID history by pressing **MENU/SELECT**. Press **▲DIR** or **▼CID** to scroll to **>CALL LOG**, then press **MENU/SELECT** twice to select **>REVIEW**.

2. Press **▲DIR** or **▼CID** to scroll through the list. A double beep sounds when the list reaches the beginning or end of the caller ID history.

3. Press **OFF/CLEAR** to exit the caller ID history.

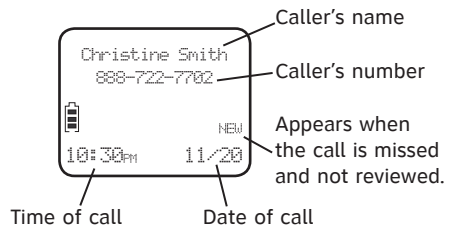

iNOTES:

- If the telephone number has more than 15 digits, only the last 15 digits appear in the caller ID history.
- Only one handset can review the caller ID history at a time. If another handset attempts to enter the caller ID history, it shows **NOT AVAILABLE AT THIS TIME**.

Caller ID operation

To view the dialing options

Although the caller ID history entries received typically have 10 digits (the area code plus the seven-digit number), in some areas, you might need to dial only the seven digits, or 1 plus the seven digits, or 1 plus the area code plus the seven digits. You can follow the steps below to change the number of digits that you dial from or store in the directory:

1. Follow steps 1 and 2 in **To review the caller ID history** on page 36 to find the entry.
2. Before dialing or saving the telephone number in the directory, press **#** repeatedly to show different dialing options for local and long distance numbers.

-OR-

Before dialing or saving the telephone number in the directory, press **1** repeatedly if you need to add or remove 1 in front of the telephone number.

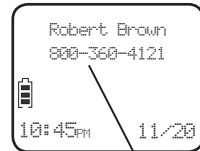

Press # → 1-800-360-4121
 Press # → 360-4121
 Press # → 1-360-4121
 Press # → 800-360-4121

-OR-

Press 1 → 1-800-360-4121
 Press 1 → 800-360-4121

NOTE: If you do not need to dial the area code for local calls, make sure to program your home area code (see **Home area code** on page 14).

To dial a number from the caller ID history

1. While reviewing the caller ID history, press **▲DIR** or **▼CID** to browse through the caller ID history and find the entry.
2. Press **PHONE/FLASH** or **SPEAKER** to dial the displayed telephone number from the caller ID history (known as Display Dial).



NOTES:

- If the telephone number has more than 15 digits, only the last 15 digits appear in the caller ID history. The telephone can still dial out all digits (up to 24 digits) of that telephone number.
- You might need to change how a caller ID number is dialed if the entry does not appear in the correct format. Caller ID numbers might appear with an area code that might not be necessary for local calls, or without a 1 that might be necessary for long distance calls. For details, see **To view the dialing options** on this page.

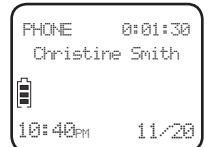

Caller ID operation

To delete caller ID history entries

To delete a caller ID history entry:

1. While reviewing the caller ID history, press **▲DIR** or **▼CID** to browse through the caller ID history and find the entry.
2. Press **MUTE/DELETE** to delete the displayed entry from the caller ID history. The screen shows **DELETING...** with a confirmation tone. Once an entry is deleted, you cannot retrieve it.



To delete all caller ID history entries:

1. Press **MENU/SELECT** in idle mode.
2. Press **▲DIR** or **▼CID** to scroll to **>CALL LOG**. Press **MENU/SELECT**.
3. Press **▲DIR** or **▼CID** to scroll to **>DEL ALL CALLS**. Press **MENU/SELECT**. The screen shows **DELETE ALL CALLS?**
4. Press **MENU/SELECT** to delete all entries from the caller ID history. The screen shows **DELETING...** with a confirmation tone. Once entries are deleted, you cannot retrieve them.
-OR-
Press **↶OFF/CLEAR** to exit and leave all entries in the caller ID history intact.



Saving a caller ID history entry in the directory

1. While reviewing the caller ID history, press **▲DIR** or **▼CID** to browse through the caller ID history and find the desired entry.
2. Press **MENU/SELECT**. The screen shows **EDIT NUMBER**.
3. Use the dial pad keys to modify the telephone number (up to 24 digits).
 - Press **▲DIR** or **▼CID** to move the cursor to the right or left.
 - Press and hold **REDIAL/PAUSE** to enter a three-second dialing pause (a **P** appears).
 - Press **MUTE/DELETE** to erase digits.
 - Press and hold **MUTE/DELETE** to erase all digits.

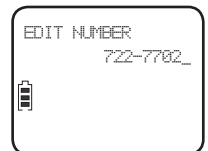

Caller ID operation

4. Press **MENU/SELECT** to save the number in the display. The screen shows **EDIT NAME**.
5. Use the dial pad keys and refer to the character chart (page 27) to modify the name (up to 15 characters).
 - Press **0** to add a space.
 - Press **▲DIR** or **▼CID** to move the cursor to the right or left.
 - Press **MUTE/DELETE** to erase characters.
 - Press and hold **MUTE/DELETE** to erase all characters.
6. Press **MENU/SELECT** to confirm. The screen shows **SAVED** with a confirmation tone.



NOTES:

- The screen shows **NUMBER ALREADY SAVED** if the number is already in the directory. You cannot save the same number more than once.
- If the directory is full, the screen shows **DIRECTORY FULL**.
- If you try to save a caller ID history entry to the directory without a number, **UNABLE TO SAVE** displays.
- If the telephone number has more than 15 digits, only the last 15 digits appear in the caller ID history. The telephone can still save all digits (up to 24 digits) of that telephone number from the caller ID history in the directory.
- You might need to change how a caller ID number is saved in the directory if the entry does not appear in the correct format. Caller ID numbers might appear with an area code that might not be necessary for local calls, or without a 1 that might be necessary for long distance calls. For details, see **To view the dialing options** on page 37.

Screen icons, indicator lights and alert tones

Screen icons



 (flashing)	Low battery; place the handset in the telephone base or charger to recharge.
 or	Indicates the battery voltage level.
 (animated display) or (animated display)	Battery is charging.
	The speakerphone is in use.
	The handset ringer is turned off.
	New voicemail received from the telephone service provider.
NEW	While reviewing the caller ID history, missed calls that have not been reviewed.
MUTE	Microphone is muted.

Handset indicator lights



CHARGE light

On when the handset is charging in the telephone base or charger.

Backlight (lighted display and dial pad)

On when a call is coming in.

On when a key is pressed.

SPEAKER light

On when the speakerphone is in use.

Screen icons, indicator lights and alert tones

Telephone base indicator lights



IN USE light

On when the handset is in use.

Flashes when another telephone on the same line is in use.

Flashes quickly when there is an incoming call.

Handset alert tones

One short beep (Key tone)	A key is pressed.
Two short beeps (Error tone)	Command has failed. You have reached the beginning or end of the list. You have reached the minimum or maximum listening volume.
Three short beeps (Out-of-range or no-power-at-base warning tone)	The handset is out of range or there is no power at the telephone base.
Three short high-pitched beeps (Confirmation tone)	The telephone has completed the command successfully.
Four short beeps (Low-battery warning tone)	Low battery warning.

Handset display screen messages

CALL LOG EMPTY	You are accessing an empty caller ID history.
CALL TRANSFERRED	You have transferred an outside call to another cordless handset.
CALLING HANDSET X	<ul style="list-style-type: none"> • The handset is calling another handset (for intercom calls). • The handset is going to transfer an outside call to another handset.
DIRECTORY EMPTY	There are no directory entries.
DIRECTORY FULL	The directory is full. You cannot save any new entries unless you delete some current entries.
ENDED	You have just ended a call.
HANDSET X IS CALLING	Another handset is calling.
INCOMING CALL	There is a call coming in.
INTERCOM	The handset is on an intercom call.
INTERCOM ENDED	The intercom call has just ended.
LINE IN USE	An extension telephone on the same line or one of the handsets is in use.
LOW BATTERY	The battery needs to be charged.
MICROPHONE ON	Mute is off so the other party can hear your voice.
MUTED	The microphone is off.
NEW VOICEMAIL	There are new voicemail messages from your telephone service provider.
NO BATTERY	You have placed the handset in the telephone base or charger without installing a battery in that handset.
NO LINE	There is no telephone line connected.
NOT AVAILABLE AT THIS TIME	Someone else is already using the directory, speed dial list or caller ID history.
NUMBER ALREADY SAVED	The telephone number you have entered is already stored in the directory.
OUT OF RANGE OR NO PWR AT BASE	The handset has lost communication with the telephone base.

Handset display screen messages

OUTSIDE CALL	You have connected to an external call during call transfer.
** PAGING **	The telephone base is paging all handsets.
PHONE	The handset is on a call.
PLACE IN CHARGER	The battery is very low. The handset should be placed in the telephone base or charger.
RINGER MUTED	The ringer is muted temporarily during an incoming call.
SAVED	The entry is now in the directory.
SPEAKER	The handset speakerphone is in use.
UNABLE TO CALL. TRY AGAIN	<ul style="list-style-type: none"> Failed intercom. While the handset is on a call, it is out of range or there is no power at the telephone base.
UNABLE TO SAVE	You cannot save a caller ID history entry without a number to the directory.
XX MISSED CALLS	There are new calls in the caller ID history.

Troubleshooting

If you have difficulty with your telephone, please try the suggestions below. For customer service, or to purchase accessories or replacement parts, visit our website at **www.telephones.att.com**, or call **1 (800) 222-3111**. In Canada, dial **1 (866) 288-4268**. When you call customer service, you will need the serial number or model number found on the bottom of the telephone base.

My telephone doesn't work at all.

- Make sure the power cord is securely plugged in.
- Make sure that the battery connector is securely plugged into the cordless handset.
- Make sure the telephone line cord is securely and firmly plugged into the telephone base and the telephone wall jack.
- Charge the battery in the cordless handset for at least 16 hours. For optimum daily performance, return the cordless handset to the telephone base when not in use.
- If the battery is depleted, it may take approximately 30 minutes to charge the handset before it shows **LOW BATTERY**. Refer to **Battery charging** on page 6 for details.
- Reset the telephone base. Unplug the electrical power. Wait for approximately 15 seconds, then plug it back in. Allow up to one minute for the cordless handset and telephone base to reset.
- You may need to purchase a new battery. Please refer to **Battery installation** on page 5.

I cannot get a dial tone.

- First try all the suggestions above.
- Move the cordless handset closer to the telephone base. You might have moved out of range.
- If the previous suggestions don't work, disconnect the telephone base from the telephone wall jack and connect the jack to a different telephone. If there is no dial tone on that telephone either, the problem is in your wiring or telephone service. Contact your telephone service provider (charges may apply).
- Your telephone line cord might be defective. Try installing a new telephone line cord.

Troubleshooting

I cannot dial out.

- First try all the suggestions in the item **I cannot get a dial tone** on page 44.
- Make sure you have a dial tone before dialing. The cordless handset may take a second or two to find the telephone base and produce a dial tone. This is normal. Wait an extra second before dialing.
- Check that all the telephones connected to the same telephone line are hung up.
- Make sure to set the dial mode to the correct setting (pulse dialing or tone dialing) for the service in your area (see **Dial mode** on page 14).
- Eliminate any background noise. Noise from a television, radio or other appliances may cause the telephone to not dial out properly. If you cannot eliminate background noise, first try muting the cordless handset before dialing, or dialing from another room in your home with less background noise.
- If the other telephones in your home are having the same problem, the problem is in your wiring or telephone service. Contact your telephone service provider (charges may apply).

My cordless handset isn't performing normally.

- Make sure the power cord is securely plugged into the telephone base. Plug the power adapter into a different, working electrical outlet not controlled by a wall switch.
- Move the cordless handset closer to the telephone base. You might have moved out of range.
- Reset the telephone base. Unplug the electrical power. Wait for 15 seconds then plug it back in. Allow up to one minute for the cordless handset and telephone base to reset.
- Other electronic products can cause interference to your cordless telephone. Try installing your telephone as far away from these types of electronic devices as possible: television sets, VCRs, or other cordless telephones.

OUT OF RANGE OR NO PWR AT BASE appears on my cordless handset.

- Ensure that the telephone base is powered up.
- Place the cordless handset in the telephone base for one minute to allow the cordless handset and base to synchronize.

Troubleshooting

- Move the cordless handset closer to the telephone base. You might have moved out of range.
- Reset the telephone base. Unplug the electrical power. Wait for 15 seconds then plug it back in. Allow up to one minute for the cordless handset and telephone base to reset.
- Other electronic products can cause interference to your cordless telephone. Try installing your telephone as far away from these types of electronic devices as possible: television sets, VCRs, or other cordless telephones.

The batteries do not hold a charge.

- If the cordless handset is in the telephone base or charger and the charge light does not come on, refer to the item **The charge light is off** on this page.
- Charge the battery in the cordless handset for at least 16 hours. For optimum daily performance, return the cordless handset to the telephone base when not in use.
- If the battery is depleted, it may take approximately 30 minutes to charge the handset before it shows **LOW BATTERY**. Refer to **Battery charging** on page 6 for details.
- You may need to purchase a new battery. Please refer to **Battery installation** on page 5.

The charge light is off.

- Make sure the power cord is plugged in correctly and securely.
- Make sure the battery is installed correctly in the handset. Follow the instructions in **Battery installation** on page 5 to install the battery.
- Unplug the electrical power. Wait for 15 seconds, then plug it back in. Allow up to one minute for the cordless handset and telephone base to reset.
- Clean the cordless handset and telephone base charging contacts each month using a pencil eraser or cloth.

Troubleshooting

I get noise, static, or weak signals even when I'm near the telephone base.

- If you subscribe to high-speed Internet service (DSL - digital subscriber line) through your telephone line, you must install a DSL filter between the telephone line cord and the telephone wall jack (see **Telephone base and charger installation** on page 4). The filter prevents noise and caller ID problems caused by DSL interference. Please contact your DSL service provider for more information about DSL filters.
- Other electronic products, such as computers, wireless routers, microwave ovens and other cordless telephones can interfere with the performance of your cordless telephone. You may be able to improve the performance of your telephone by installing the telephone base as far away as possible from other electronic devices.
- Do not install this telephone near a microwave oven or on the same electrical outlet. You may experience decreased performance while the microwave oven is operating.
- If your telephone is plugged in with a modem or a surge protector, plug the telephone (or modem/surge protector) into a different location. If this doesn't solve the problem, relocate your telephone or modem farther apart from one another, or use a different surge protector.
- Move your telephone to a higher location. The telephone will likely have better reception when installed in a high area.
- If the other telephones in your home are having the same problem, the problem is in your wiring or telephone service. Contact your telephone service provider (charges may apply).

I experience poor sound quality when using the speakerphone.

- For increased sound quality while using the speakerphone, place the handset on a flat surface with the dial pad facing up.
- When using a speakerphone, controlling background noise in your environment is essential. While you are listening to your party, press **MUTE/DELETE** to temporarily turn your microphone off. When it is your turn to speak, remember to press **MUTE/DELETE** again to turn the microphone on.

Troubleshooting

- Excessive background noise will cause a speakerphone to fade in and out. Try controlling the background noise by turning off any audio devices near the speakerphone. Also, try to avoid interrupting the person at the other end of the conversation while the person is speaking. If background noise cannot be controlled, you should terminate speakerphone operation and return to normal handset mode.

I hear other calls while using my telephone.

- Disconnect the telephone base from the telephone wall jack, and plug in a different telephone. If you still hear other calls, the problem is probably in your wiring or telephone service. Call your telephone service provider (charges may apply).

My calls cut in and out while I'm using my cordless handset.

- Other electronic products can cause interference to your cordless telephone. Try installing your telephone as far away as possible from electronic devices such as wireless routers, or other cordless telephones.
- Move the handset closer to the base. The operating range may vary with environmental conditions and time of use. There may be places within your environment that a cordless telephone will not work well. If the problem only occurs in certain areas of your environment, you can conclude that there is nothing wrong with the telephone.
- Do not install this telephone near a microwave oven or on the same electrical outlet. You may experience decreased performance while the microwave oven is operating.
- If your telephone is plugged in with a modem or surge protector, plug the telephone (or modem/surge protector) into a different location. If this doesn't solve the problem, relocate your telephone or modem farther apart from one another, or use a different surge protector.
- Move your telephone base to a higher location. The telephone will have better reception when installed in a high area.
- If the other telephones in your home are having the same problem, the problem is in your wiring or telephone service. Contact your telephone service provider (charges may apply).

Troubleshooting

- If you subscribe to high-speed Internet service (DSL - digital subscriber line) through your telephone line, you must install a DSL filter between the telephone line cord and the telephone wall jack (see **Telephone base and charger installation** on page 4). The filter prevents noise and caller ID problems caused by DSL interference. Please contact your DSL service provider for more information about DSL filters.

My cordless handset does not ring when I receive a call.

- Make sure that the ringer is not turned off. Refer to **Ringer volume** on page 11.
- Make sure the telephone line cord is plugged securely into the telephone base and the telephone wall jack. Make sure the power cord is securely plugged in.
- The cordless handset may be too far from the telephone base.
- Charge the battery in the cordless handset for at least 16 hours. For optimum daily performance, return the cordless handset to the telephone base when not in use.
- You may have too many extension telephones on your telephone line to allow all of them to ring simultaneously. Try unplugging one telephone at a time until the telephone starts ringing.
- The layout of your home or office might be limiting the operating range. Try moving the telephone base to another location, preferably on an upper floor.
- If the other telephones in your home are having the same problem, the problem is in your wiring or telephone service. Contact your telephone service provider (charges may apply).
- Test a working telephone at the telephone wall jack. If another telephone has the same problem, the problem is the telephone wall jack. Contact your telephone service provider (charges may apply).
- Other electronic products can cause interference to your cordless telephone. Try installing your telephone as far away as possible from electronic devices such as wireless routers, or other cordless telephones.
- Completely remove then replace the battery. Place the cordless handset in the telephone base. Wait for the cordless handset to reestablish its connection with the telephone base. Allow up to one minute for this to take place.
- Your telephone line cord might be defective. Try installing a new telephone line cord.

Troubleshooting

My caller ID isn't working.

- Caller ID is a subscription service. You must subscribe to this service from your telephone service provider for this feature to work on your telephone.
- Your caller may not be calling from an area that supports caller ID.
- Both your and your caller's telephone service providers must use caller ID compatible equipment.
- Make sure the home area code is set correctly in the telephone (see **Home area code** on page 14).
- If you subscribe to high-speed Internet service (DSL - digital subscriber line) through your telephone line, you must install a DSL filter between the telephone line cord and the telephone wall jack (see **Telephone base and charger installation** on page 4). The filter prevents noise and caller ID problems caused by DSL interference. Please contact your DSL service provider for more information about DSL filters.

My telephone does not receive caller ID when on a call.

- Make sure you subscribe to caller ID with call waiting features provided by your telephone service provider. Caller ID features work only if both you and the caller are in areas offering caller ID service, and if both telephone service providers use compatible equipment.

A icon shows on the display and I don't know why.

- Your telephone has voicemail indication. If  appears on the display, then your telephone has received a signal from your telephone service provider that you have a voicemail message waiting for you to retrieve from your telephone service provider. Contact your telephone service provider for more information on how to access your voicemail.

I subscribe to a nontraditional telephone service that uses my computer to establish connections, and my telephone doesn't work.

- Make sure your computer is powered on.
- Make sure your Internet connection is working properly.
- Make sure that the software is installed and running for your nontraditional telephone service.

Troubleshooting

- Make sure to plug your USB telephone adapter into a dedicated USB port on your computer. Do not plug it into a multiple port USB hub (USB splitter) that is not powered.
- In a few rare instances, the USB port on your computer may not have enough power. In these instances, try using a USB hub with its own external power supply.
- If you are using a firewall, it may prevent access to your nontraditional telephone service. Contact your service provider for more information.

Common cure for electronic equipment:

If the telephone is not responding normally, try resetting it. Do the following in the order listed:

1. Disconnect the power to the telephone base.
2. Disconnect the cordless handset battery.
3. Wait a few minutes.
4. Connect power to the telephone base.
5. Completely remove then replace the battery. Place the cordless handset into the telephone base.
6. Wait for the cordless handset to reestablish its connection with the telephone base. Allow up to one minute for this to take place.

Maintenance

Taking care of your telephone

- Your cordless telephone contains sophisticated electronic parts, so it must be treated with care.
- Avoid rough treatment.
- Place the handset down gently.
- Save the original packing materials to protect your telephone if you ever need to ship it.

Avoid water

- Your telephone can be damaged if it gets wet. Do not use the handset in the rain, or handle it with wet hands. Do not install the telephone base near a sink, bathtub or shower.

Electrical storms

- Electrical storms can sometimes cause power surges harmful to electronic equipment. For your own safety, take caution when using electric appliances during storms.

Cleaning your telephone

- Your telephone has a durable plastic casing that should retain its luster for many years. Clean it only with a soft cloth slightly dampened with water or mild soap.
- Do not use excess water or cleaning solvents of any kind.

Remember that electrical appliances can cause serious injury if used when you are wet or standing in water. If the telephone base should fall into water, DO NOT RETRIEVE IT UNTIL YOU UNPLUG THE POWER CORD AND TELEPHONE LINE CORDS FROM THE WALL. Then pull the telephone out by the unplugged cords.

Important safety information

 This symbol is to alert you to important operating or servicing instructions that may appear in this user's manual. Always follow basic safety precautions when using this product to reduce the risk of injury, fire, or electric shock.

Safety information

- **Read and understand all instructions in the user's manual. Observe all markings on the product.**
- **Avoid using a telephone during a thunderstorm.** There might be a slight chance of electric shock from lightning.
- **Do not use a telephone in the vicinity of a gas leak.** Under certain circumstances, a spark may be created when the adapter is plugged into the power outlet, or when the handset is replaced in its cradle. This is a common event associated with the closing of any electrical circuit. The user should not plug the phone into a power outlet, and should not put a charged handset into the cradle, if the phone is located in an environment containing concentrations of flammable or flame-supporting gases, unless there is adequate ventilation. A spark in such an environment could create a fire or explosion. Such environments may include: medical use of oxygen without adequate ventilation; industrial gases (cleaning solvents; gasoline vapors; etc.); a leak of natural gas; etc.
- **Do not use this product near water, or when you are wet.** For example, do not use it in a wet basement or shower, or next to a swimming pool, bathtub, kitchen sink, or laundry tub. Do not use liquids or aerosol sprays for cleaning. If the product comes in contact with any liquids, unplug any line or power cord immediately. Do not plug the product back in until it has dried thoroughly.
- **Install this product in a protected location** where no one can trip over any line or power cords. Protect cords from damage or abrasion.
- **If this product does not operate normally, read Troubleshooting on pages 44-51 in this user's manual.** If you cannot solve the problem, or if the product is damaged, refer to **Limited warranty** on pages 58-60. Do not open this product except as may be directed in your user's manual. Opening the product or reassembling it incorrectly may expose you to hazardous voltages or other risks.
- **Replace batteries only as described in Battery installation and charging on pages 5-6 in your user's manual.** Do not burn or puncture batteries — they contain caustic chemicals.
- **The power adapters are intended to be correctly oriented in a vertical or floor mount position.** The prongs are not designed to hold the plug in place if they are plugged into a ceiling or an under-the-table or cabinet outlet.

 **CAUTION:** Use only the power adapters provided with this product. To obtain a replacement, visit our website at **www.telephones.att.com**, or call **1 (800) 222-3111**. In Canada, dial **1 (866) 288-4268**.

Especially about cordless telephones

- **Privacy:** The same features that make a cordless telephone convenient create some limitations. Telephone calls are transmitted between the telephone base and the handset by radio waves, so there is a possibility that your cordless telephone conversations could be intercepted by radio receiving equipment within range of the cordless handset. **For this reason, you should not think of cordless telephone conversations as being as private as those on corded telephones.**

Important safety information

- **Electrical power:** The telephone base of this cordless telephone must be connected to a working electrical outlet which is not controlled by a wall switch. **Calls cannot be made from the handset if the telephone base is unplugged, switched off or if the electrical power is interrupted.**
- **Potential TV interference:** Some cordless telephones operate at frequencies that may cause interference to TVs and VCRs. To minimize or prevent such interference, do not place the telephone base of the cordless telephone near or on top of a TV or VCR. If interference is experienced, moving the cordless telephone farther away from the TV or VCR will often reduce or eliminate the interference.
- **Rechargeable batteries:** This product contains nickel-metal hydride rechargeable batteries. Exercise care in handling batteries in order not to create a short circuit with conductive material such as rings, bracelets, and keys. The battery or conductor may overheat and cause harm. Observe proper polarity between the battery and the battery charger.
- **Nickel-metal hydride rechargeable batteries:** Dispose of these batteries in a safe manner. Do not burn or puncture. Like other batteries of this type, if burned or punctured, they could release caustic material which could cause injury.



The RBRC™ Seal means that the manufacturer is voluntarily participating in an industry program to collect and recycle nickel-metal hydride rechargeable batteries when taken out of service within the United States. These batteries may be taken to a participating local retailer of replacement batteries or recycling center. Or you may call 1 (800) 8-BATTERY for locations accepting spent Ni-MH batteries.

Precautions for users of implanted cardiac pacemakers

Cardiac pacemakers (applies only to digital cordless telephones): Wireless Technology Research, LLC (WTR), an independent research entity, led a multidisciplinary evaluation of the interference between portable wireless telephones and implanted cardiac pacemakers. Supported by the U.S. Food and Drug Administration, WTR recommends to physicians that:

Pacemaker patients

- Should keep wireless telephones at least six inches from the pacemaker.
- Should NOT place wireless telephones directly over the pacemaker, such as in a breast pocket, when it is turned ON.
- Should use the wireless telephone at the ear opposite the pacemaker.

WTR's evaluation did not identify any risk to bystanders with pacemakers from other persons using wireless telephones.

Especially about telephone answering systems

Two-way recording: This unit does not sound warning beeps to inform the other party that the call is being recorded. To ensure that you are in compliance with any federal or state regulations regarding recording a telephone call, you should start the recording process and then inform the other party that you are recording the conversation.

SAVE THESE INSTRUCTIONS

FCC Part 68 and ACTA

This equipment complies with Part 68 of the FCC rules and with technical requirements adopted by the Administrative Council for Terminal Attachments (ACTA). The label on the back or bottom of this equipment contains, among other things, a product identifier in the format US:AAAEQ##TXXXX. This identifier must be provided to your telephone service provider upon request.

The plug and jack used to connect this equipment to premises wiring and the telephone network must comply with the applicable Part 68 rules and technical requirements adopted by ACTA. A compliant telephone cord and modular plug is provided with this product. It is designed to be connected to a compatible modular jack that is also compliant. An RJ11 jack should normally be used for connecting to a single line and an RJ14 jack for two lines. See Installation Instructions in the user's manual.

The Ringer Equivalence Number (REN) is used to determine how many devices you may connect to your telephone line and still have them ring when you are called. The REN for this product is encoded as the 6th and 7th characters following the US: in the product identifier (e.g., if ## is 03, the REN is 0.3). In most, but not all areas, the sum of all RENs should be five (5.0) or less. For more information, please contact your telephone service provider.

This equipment may not be used with Party Lines. If you have specially wired alarm dialing equipment connected to your telephone line, ensure the connection of this equipment does not disable your alarm equipment. If you have questions about what will disable the alarm equipment, consult your telephone service provider or a qualified installer.

If this equipment is malfunctioning, it must be unplugged from the modular jack until the problem has been corrected. Repairs to this telephone equipment can only be made by the manufacturer or its authorized agents. For repair procedures, follow the instructions outlined under the Limited Warranty.

If this equipment is causing harm to the telephone network, the telephone service provider may temporarily discontinue your telephone service. The telephone service provider is required to notify you before interrupting service. If advance notice is not practical, you will be notified as soon as possible. You will be given the opportunity to correct the problem and the telephone service provider is required to inform you of your right to file a complaint with the FCC. Your telephone service provider may make changes in its facilities, equipment, operation, or procedures that could affect the proper functioning of this product. The telephone service provider is required to notify you if such changes are planned.

If this product is equipped with a corded or cordless handset, it is hearing aid compatible.

If this product has memory dialing locations, you may choose to store emergency telephone numbers (e.g., police, fire, medical) in these locations. If you do store or test emergency numbers, please:

- Remain on the line and briefly explain the reason for the call before hanging up.
- Perform such activities in off-peak hours, such as early morning or late evening.

Industry Canada

Operation is subject to the following two conditions: (1) this device may not cause harmful interference, and (2) this device must accept any interference, including interference that may cause undesired operation.

The term "IC:" before the certification/registration number only signifies that the Industry Canada technical specifications were met.

FCC Part 68 and ACTA

The Ringer Equivalence Number (REN) for this terminal equipment is 0.1B. The REN is an indication of the maximum number of devices allowed to be connected to a telephone interface. The termination on an interface may consist of any combination of devices subject only to the requirement that the sum of the RENs of all the devices does not exceed five.

This product meets the applicable Industry Canada technical specifications.

FCC Part 15

This equipment has been tested and found to comply with the requirements for a Class B digital device under Part 15 of the Federal Communications Commission (FCC) rules.

These requirements are intended to provide reasonable protection against harmful interference in a residential installation. This equipment generates, uses and can radiate radio frequency energy and, if not installed and used in accordance with the instructions, may cause harmful interference to radio communications. However, there is no guarantee that interference will not occur in a particular installation.

If this equipment does cause harmful interference to radio or television reception, which can be determined by turning the equipment off and on, the user is encouraged to try to correct the interference by one or more of the following measures:

- Reorient or relocate the receiving antenna.
- Increase the separation between the equipment and receiver.
- Connect the equipment into an outlet on a circuit different from that to which the receiver is connected.
- Consult the dealer or an experienced radio/TV technician for help.

Changes or modifications to this equipment not expressly approved by the party responsible for compliance could void the user's authority to operate the equipment.

This device complies with Part 15 of the FCC rules. Operation is subject to the following two conditions: (1) this device may not cause harmful interference, and (2) this device must accept any interference received, including interference that may cause undesired operation. Privacy of communications may not be ensured when using this telephone.

To ensure safety of users, the FCC has established criteria for the amount of radio frequency energy that can be safely absorbed by a user or bystander according to the intended usage of the product. This product has been tested and found to comply with the FCC criteria. The handset may be safely held against the ear of the user. The telephone base shall be installed and used such that parts of the user's body other than the hands are maintained at a distance of approximately 20cm (8 inches) or more.

This Class B digital apparatus complies with Canadian ICES-003.

Limited warranty

The AT&T brand is used under license - any repair, replacement or warranty service, and all questions about this product should be directed to our website at **www.telephones.att.com** or call **1 (800) 222-3111**. In Canada, dial **1 (866) 288-4268**.

1. What does this limited warranty cover?

The manufacturer of this AT&T branded product warrants to the holder of a valid proof of purchase (“CONSUMER” or “you”) that the product and all accessories provided in the sales package (“PRODUCT”) are free from defects in material and workmanship, pursuant to the following terms and conditions, when installed and used normally and in accordance with the PRODUCT operating instructions. This limited warranty extends only to the CONSUMER for products purchased and used in the United States of America and Canada.

2. What will be done if the PRODUCT is not free from defects in materials and workmanship during the limited warranty period (“materially defective PRODUCT”)?

During the limited warranty period, the manufacturer’s authorized service representative repairs or replaces at the manufacturer’s option, without charge, a materially defective PRODUCT. If the manufacturer repairs the PRODUCT, they may use new or refurbished replacement parts. If the manufacturer chooses to replace the PRODUCT, they may replace it with a new or refurbished PRODUCT of the same or similar design. The manufacturer retains the defective parts, modules, or equipment. Repair or replacement of the PRODUCT, at the manufacturer’s option, is your exclusive remedy. The manufacturer returns the repaired or replacement products to you in working condition. You should expect the repair or replacement to take approximately 30 days.

3. How long is the limited warranty period?

The limited warranty period for the PRODUCT extends for ONE (1) YEAR from the date of purchase. If the manufacturer repairs or replaces a materially defective PRODUCT under the terms of this limited warranty, this limited warranty also applies to repaired or replacement PRODUCT for a period of either (a) 90 days from the date the repaired or replacement PRODUCT is shipped to you or (b) the time remaining on the original one-year limited warranty; whichever is longer.

4. What is not covered by this limited warranty?

This limited warranty does not cover:

- PRODUCT that has been subjected to misuse, accident, shipping or other physical damage, improper installation, abnormal operation or handling, neglect, inundation, fire, water, or other liquid intrusion; or
- PRODUCT that has been damaged due to repair, alteration, or modification by anyone other than an authorized service representative of the manufacturer; or
- PRODUCT to the extent that the problem experienced is caused by signal conditions, network reliability or cable or antenna systems; or
- PRODUCT to the extent that the problem is caused by use with non-AT&T accessories; or
- PRODUCT whose warranty/quality stickers, PRODUCT serial number plates or electronic serial numbers have been removed, altered or rendered illegible; or

Limited warranty

- PRODUCT purchased, used, serviced, or shipped for repair from outside the United States of America or Canada, or used for commercial or institutional purposes (including but not limited to products used for rental purposes); or
- PRODUCT returned without a valid proof of purchase (see item 6 below); or
- Charges for installation or setup, adjustment of customer controls, and installation or repair of systems outside the unit.

5. How do you get warranty service?

To obtain warranty service in the United States of America, visit

www.telephones.att.com or call **1 (800) 222-3111**. In Canada, dial **1 (866) 288-4268**.

NOTE: Before calling for service, please review the user's manual. A check of the PRODUCT's controls and features might save you a service call.

Except as provided by applicable law, you assume the risk of loss or damage during transit and transportation and are responsible for delivery or handling charges incurred in the transport of the PRODUCT(s) to the service location. The manufacturer will return repaired or replaced PRODUCT under this limited warranty. Transportation, delivery or handling charges are prepaid. The manufacturer assumes no risk for damage or loss of the PRODUCT in transit. If the PRODUCT failure is not covered by this limited warranty, or proof of purchase does not meet the terms of this limited warranty, the manufacturer notifies you and requests that you authorize the cost of repair prior to any further repair activity. You must pay for the cost of repair and return shipping costs for the repair of products that are not covered by this limited warranty.

6. What must you return with the PRODUCT to get warranty service?

You must:

- a. Return the entire original package and contents including the PRODUCT to the service location along with a description of the malfunction or difficulty; and
- b. Include a "valid proof of purchase" (sales receipt) identifying the PRODUCT purchased (PRODUCT model) and the date of purchase or receipt; and
- c. Provide your name, complete and correct mailing address, and telephone number.

7. Other limitations

This warranty is the complete and exclusive agreement between you and the manufacturer of this AT&T branded PRODUCT. It supersedes all other written or oral communications related to this PRODUCT. The manufacturer provides no other warranties for this PRODUCT. The warranty exclusively describes all of the manufacturer's responsibilities regarding the PRODUCT. There are no other express warranties. No one is authorized to make modifications to this limited warranty and you should not rely on any such modification.

State/Provincial Law Rights: This warranty gives you specific legal rights, and you might also have other rights that vary from state to state or province to province.

Limitations: Implied warranties, including those of fitness for a particular purpose and merchantability (an unwritten warranty that the PRODUCT is fit for ordinary use) are limited to one year from date of purchase. Some states/provinces do not allow limitations on how long an implied warranty lasts, so the above limitation might not apply to you. In no event shall the manufacturer be liable for any indirect, special, incidental, consequential, or similar damages

Limited warranty

(including, but not limited to lost profits or revenue, inability to use the PRODUCT or other associated equipment, the cost of substitute equipment, and claims by third parties) resulting from the use of this PRODUCT. Some states/provinces do not allow the exclusion or limitation of incidental or consequential damages, so the above limitation or exclusion might not apply to you.

Please retain your original sales receipt as proof of purchase.

Technical specifications

RF frequency band	1921.536MHz – 1928.448MHz
Channels	5
Operating temperature	32°F – 122°F 0°C – 50°C
Telephone base voltage (AC voltage, 60Hz)	96 – 130Vrms
Telephone base voltage (AC adapter output)	AC6V @300mA
Handset voltage	DC2.4 – 3.2V
Charger voltage (AC adapter output)	AC6V @300mA
Operating times*	Talk time (handset): up to seven hours Talk time (speakerphone): up to five hours Standby: up to seven days

* Operating time varies depending on your actual use and the age of the battery.

DECT 6.0 digital technology

Telecommunications (DECT) 6.0 is a new frequency band that transmits your voice across multiple channels. This technology provides superior quality of voice and sound, high protection against wiretapping and better range than 2.4 GHz and 5.8 GHz phone systems, while not interfering with wireless routers.

Telephone operating range

This cordless telephone operates within the maximum power allowed by the Federal Communications Commission (FCC). Even so, this handset and telephone base can communicate over only a certain distance — which can vary with the locations of the telephone base and handset, the weather, and the construction of your home or office.

Index

A

- Alert tones, 41
- Alphabetical search, 28
- Answer a call, 16
- Answer an incoming call during an intercom call, 23
- Any key answer, 16
- Area code, 14, 33, 37
- Auto off, 16

B

- Battery charging, 6
- Battery installation, 5

C

- Caller ID, 33
- Caller ID history (call log), 34–39
- Call transfer (intercom transfer), 24
- Call waiting, 19, 33
- Chain dialing, 20
- Character chart, 27
- Charger installation, 4
- Clock, 13

D

- Date and time, 13
- Delete all entries from caller ID history, 38
- Dial a directory number, 30
- Dial a number from caller ID history, 37
- Dial a redial list number, 17
- Dial a speed dial number, 32

- Dialing options, 37
- Dial mode, 14
- Directory, 25–30
- Directory storage, 26
- Display dial, 17, 30, 32, 37
- Display screen messages, 42
- DSL filter, 4, 7

E

- Elapsed time, 15
- End a call, 16

F

- Flash, 19

H

- Handset locator, 22
- Handset ringer tone (selectable ringer tone), 11
- Handset ringer volume (ringer volume control), 11
- Handset volume control, 19

I

- Important safety information, 53
- Indicator lights, 40
- Intercom call (intercom between handsets), 23

K

- Key tone, 13

L

- Language, 12
- Limited warranty, 58

Index

M

Maintenance, 52
Make a call, 15
Memory match, 34
Menu, 10–14
Missed (new) calls indicator, 35
Mute, 19

O

Operation time, 61

P

Pause, 15, 26
Power adapter, 4
Predialing (on-hook dialing), 15

R

Reasons for missing caller ID information, 35
Redial, 17
Ring tone, 11

S

Screen icons, 40
Speakerphone switching, 16
Speed dial, 31–32

T

Tabletop installation, 4
Technical specifications, 61
Temporary ringer silencing, 15
Temporary tone dialing, 20
Three-way conversation, 21, 24
Troubleshooting, 44

V

Voicemail, 12
Volume, 11, 19

W

Wall mount installation, 7



www.telephones.att.com