



at&t

User's manual

ML17929

**Two-line corded telephone
with caller ID/call waiting**



Congratulations

on purchasing your new AT&T product. Before using this AT&T product, please read **Important safety information** on page 49 of this user's manual. Please thoroughly read the user's manual for all the feature operations and troubleshooting information you need to install and operate your new AT&T product. You can also visit our website at www.telephones.att.com or call **1 (800) 222-3111**. In Canada, dial **1 (866) 288-4268**.

Model number: ML17929

Type: Two-line corded telephone with caller ID/call waiting

Serial number: _____

Purchase date: _____

Place of purchase: _____

Both the model and serial numbers of your AT&T product can be found on the bottom of the telephone base.



Telephones identified with this logo have reduced noise and interference when used with most T-coil equipped hearing aids and cochlear implants. The TIA-1083 Compliant Logo is a trademark of the Telecommunications Industry Association. Used under license.

Clearspeak™ is a trademark of Advanced American Telephones.

© 2011 Advanced American Telephones. All Rights Reserved. AT&T and the AT&T logo are trademarks of AT&T Intellectual Property licensed to Advanced American Telephones, San Antonio, TX 78219. Printed in China.

Parts checklist

Your telephone package contains the following items. Save your sales receipt and original packaging in the event warranty service is necessary.



Telephone base



Handset with coiled handset cord



Power adapter

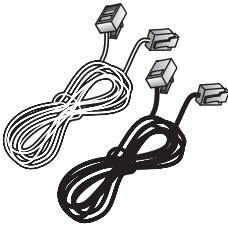

Telephone line cords: clear (2-conductor) and black (4-conductor)



Mounting bracket

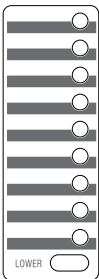

Replacement directory card

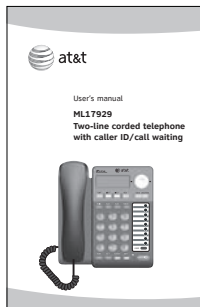

User's manual

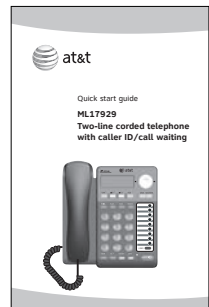

Quick start guide

User's manual

ML17929

Two-line corded telephone with caller ID/call waiting



Table of contents

Getting started

Quick reference guide	2
Telephone installation	4
Telephone base installation.....	4
Data port	7
Installation options.....	8
Tabletop to wall installation.....	8
Wall to tabletop installation	10
Optional headset.....	12
Directory card	12

Menu setup

Telephone settings	13
Menu overview	13
Set date and time.....	14
Set the primary line.....	14
Choose the preferred mode.....	15
LCD backlight.....	15
Ringer volume	16
Language	16
Set home and local area codes..	17
Voicemail indicator settings.....	18
Voicemail indicator.....	18
Clear voicemail indication	18
Turn COVM (central office voicemail) on or off.....	19

Telephone operation

Basic operation	20
Making, answering or ending a call	20
On hook dialing (predialing).....	21
Clearspeak™ dial-in-base speakerphone.....	21

Switching between the handset, headset and speakerphone.....	21
Redial.....	22
Options while on calls.....	23
Volume control.....	23
Flash/call waiting	23
Mute.....	23
Hold	23
Switching between lines	24
Conference calls.....	24
Chain dialing	25
Line power mode (no AC power).....	26
To make a call during a power failure.....	26
To answer a call during a power failure.....	26

Speed dial

Speed dial memory overview.....	27
Speed dial operation.....	28
Storing a number in a speed dial location	28
Reviewing a speed dial number ..	28
Editing a speed dial number	29
Turn auto speaker on or off.....	29
Dialing a speed dial number	30
Deleting a speed dial number.....	30

Directory

About the directory.....	31
Directory memory capacity.....	31
Character chart.....	31
Create directory entries.....	32
Creating a directory entry	32

Reviewing directory entries	33
Searching by name	33
Review the directory.....	33
Dial, delete or edit	
directory entries.....	34
Display dial.....	34
Deleting directory entries.....	34
Editing directory entries.....	34

Caller ID

About caller ID	35
Information about caller ID with	
call waiting.....	35
How caller ID history (call log)	
works.....	36
Caller ID operation.....	37
Memory match	37
Missed calls indicator	37
Reviewing call history.....	37
Dialing options.....	38
Display dial.....	38
Deleting call history entries	38
Saving a call history entry to	
the directory.....	39
Saving a call history entry to a	
speed dial location.....	40
Reasons for missing caller ID	
information	41

Appendix

Indicator lights and alert tones.....	42
Indicator lights	42
Alert tones	42
Screen display messages	43
Troubleshooting	44
General product care	48
Important safety information	49
Safety information.....	49
Especially about corded	
telephones.....	49
FCC and ACTA information.....	50
Part 15 of FCC rules.....	52
Industry Canada.....	52

Limited warranty.....	53
Technical specifications.....	55

Index

Index.....	56
------------	----

Installation preparation

You must install the power adapter before using the telephone.



See pages 5-6 for easy instructions.

If you subscribe to high speed Internet service (DSL - digital subscriber line) through your telephone line, you must install a DSL filter between each telephone line cord and telephone wall jack (pages 5 and 6). The filter prevents noise and caller ID problems caused by DSL interference. Please contact your DSL service provider for more information about DSL filters.

Your product may be shipped with a protective sticker covering the telephone base display - remove it before use.

For customer service or product information, visit our website at

www.telephones.att.com or call **1 (800) 222-3111**. In Canada, dial **1 (866) 288-4268**.

Quick reference guide

CID ◀

Press to display call history information when the telephone is idle (page 37).

When entering numbers or names, press to move the cursor to the left.

LINE 1, LINE 2

Press to make or answer a call on the selected line (page 20).

CONF

Press to initiate a three-way conference call (page 24).

HOLD

Press to place a call on hold (page 23).

REDIAL

Press to dial the last number dialed when the telephone is off hook (page 22).

When the telephone is idle, press to display the last five numbers dialed. You can choose to dial a displayed number (pages 22).

FLASH

During a call, press to answer an incoming call when you receive a call waiting alert (page 23).

PAUSE

Press to insert a two-second dialing pause in a number stored in the speed dial memory or directory (pages 28 and 32).

▼/▲

While in a menu, press to scroll up or down.

▶/DIR

Press to enter the directory when the telephone is idle (page 33).

When entering numbers or names, press to move the cursor to the right.

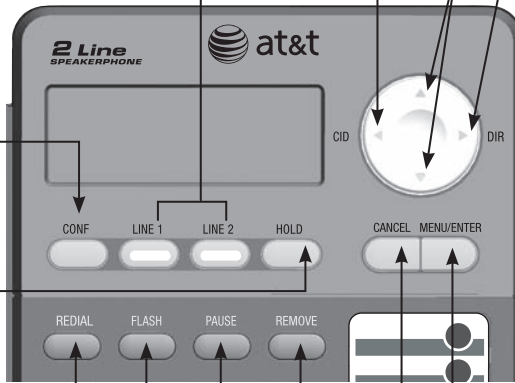

MENU/ENTER

Press to enter the main menu (page 13).

While in a menu, press to choose an item, or save an entry or setting.

CANCEL

Press to cancel an operation and go back to the previous menu (page 13).

Press and hold to return to idle mode (page 13).

REMOVE

Press to delete the displayed directory, or call history entry (pages 34 and 38).

While entering numbers or names, press to backspace and erase a digit or character (pages 28 and 32).

Quick reference guide

Speed dial keys

Press to dial or review a stored speed dial number when the telephone is idle (pages 28 and 30).

VOL+

When the telephone is idle, press to increase the ringer volume for both lines (page 16).

During a call, press to increase the listening volume (page 23).

When a line is ringing, press to increase the ringer volume of that line temporarily (page 16).

VOL-

While the telephone is not in use, press to decrease the ringer volume for both lines (page 16).

During a call, press to decrease the listening volume (page 23).

When a line is ringing, press to decrease the ringer volume of that line temporarily (page 16).

HEADSET

Press to activate the headset when a corded headset is connected (page 20).

MUTE

During a call, press to mute the microphone (page 23).



SPEAKER

Press to turn the base speakerphone on or off (page 20).

LOWER

Press to enter the lower locations of the speed dial keys (page 27).

Telephone installation

Telephone base installation

1. Install the mounting bracket for tabletop use.

Option 1: To install your telephone in a low tabletop position, insert the fixed tabs of the mounting bracket into the slots labeled (a). Press the flexible tabs into the slots labeled (b) until they click into place.



Mounting bracket

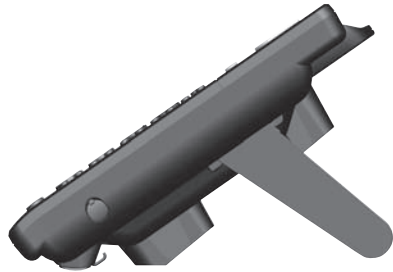

Option 1: Low tabletop position

Option 2: To install your telephone in a high tabletop position, insert the fixed tabs of the mounting bracket into the slots labeled (b). Press the flexible tabs into the slots labeled (a) until they click into place.

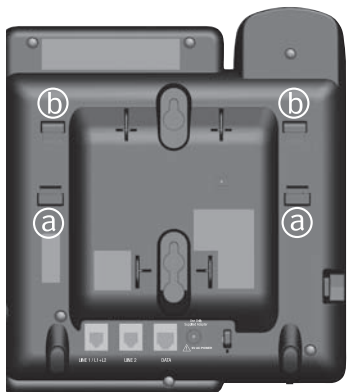

Mounting bracket



Option 2: High tabletop position

Telephone installation

2. Connect the telephone line cord(s) and the power cord to the telephone base.

If you subscribe to high speed Internet service (DSL - digital subscriber line) through your telephone line, you must install a DSL filter between each telephone line cord and telephone wall jack. The filter prevents noise and caller ID problems caused by DSL interference. Please contact your DSL service provider for more information about DSL filters.

Option 1: If you have a two-line wall jack, install your telephone base as shown below.

Plug the other end of the black telephone line cord (4-conductor) into the wall jack.

Plug the large end of the power adapter into an electrical outlet not controlled by a wall switch.

If you have DSL high speed Internet service, a DSL filter (not included) is required.

Plug one end of the black telephone line cord (4-conductor) into the jack labeled **LINE 1/L1+L2** on the back of the telephone base.

Plug the small end of the power adapter into the power jack on the back of the telephone base.

Plug the other end of the coiled handset cord into the jack at the left side of the telephone base.

One end of the coiled telephone line cord has already been plugged into the handset. Make sure it is plugged in firmly.



NOTES:

- Use only the power adapter supplied with this product. To order a replacement power adapter, visit our website at www.telephones.att.com, or call **1 (800) 222-3111**. In Canada, dial **1 (866) 288-4268**.
- The power adapter is intended to be correctly oriented in a vertical or floor mount position. The prongs are not designed to hold the plug in place if it is plugged into a ceiling, under-the-table or cabinet outlet.

Telephone installation

Option 2: If you have two one-line wall jacks, install your telephone base as shown below.

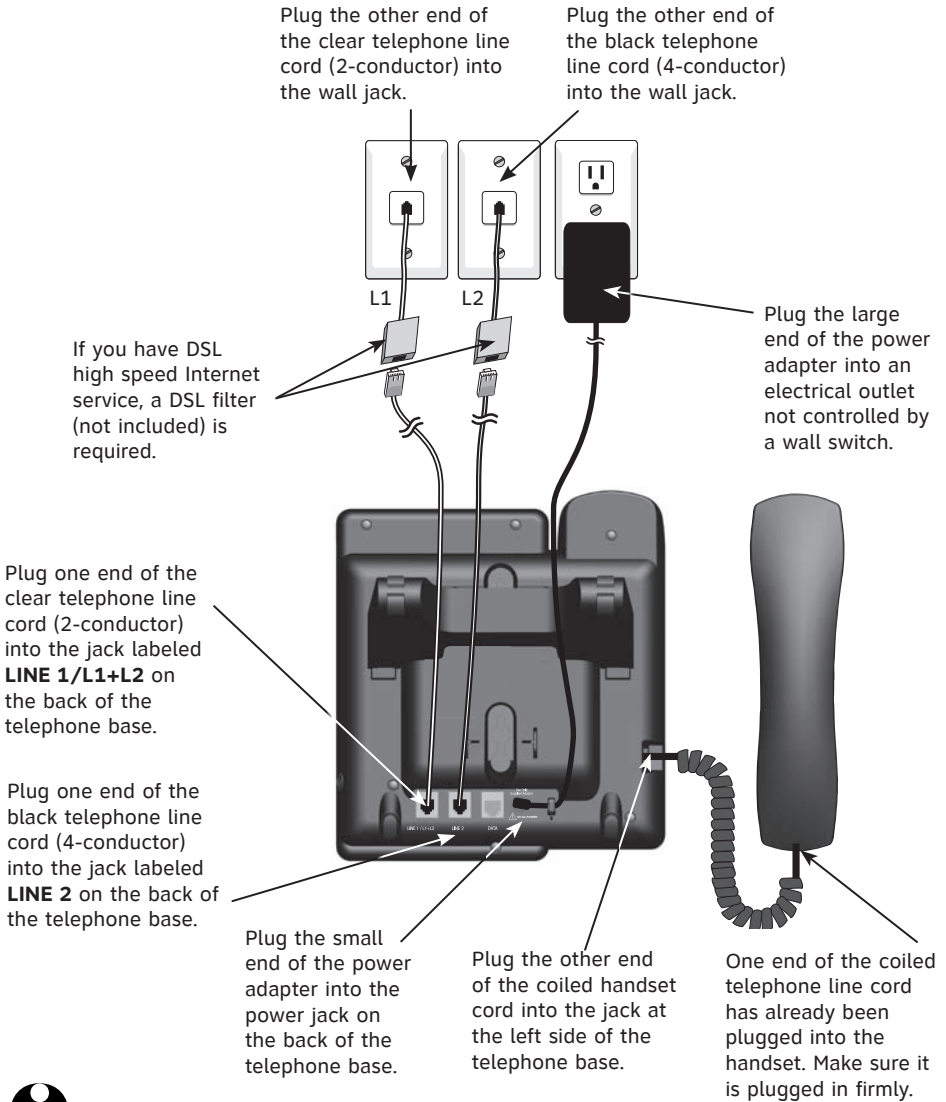

NOTES:

- Use only the power adapter supplied with this product. To order a replacement power adapter, visit our website at www.telephones.att.com, or call **1 (800) 222-3111**. In Canada, dial **1 (866) 288-4268**.
- The power adapter is intended to be correctly oriented in a vertical or floor mount position. The prongs are not designed to hold the plug in place if it is plugged into a ceiling, under-the-table or cabinet outlet.

Data port

If you want to connect another device (such as a modem or fax machine) to the wall jack, use the jack labeled **DATA** on the back of the telephone base. The data port uses line 2 only.

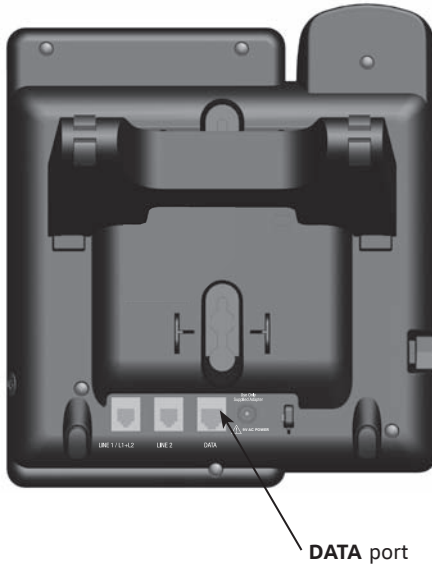

Installation options

If you want to mount your telephone on a wall, connect the telephone base to a standard dual-stud telephone wall mounting plate. If you do not have this mounting plate, you can purchase one from many hardware or consumer electronics retailers. Professional assistance may be required to install the mounting plate.

Tabletop to wall installation

To install your telephone base in the wall installation position, make sure you first unplug the power adapter from the electrical outlet and the telephone line cord from the wall outlet.

1. Hold down the switch hook on the telephone base, then slide the handset tab upwards to remove it from the slot. Rotate the handset tab 180° degrees. Push the handset tab down into the slot until it locks into position.



2. Depending on whether the mounting bracket is in low or high tabletop position, press the flexible tabs to release the mounting bracket. Remove the mounting bracket from the telephone base.

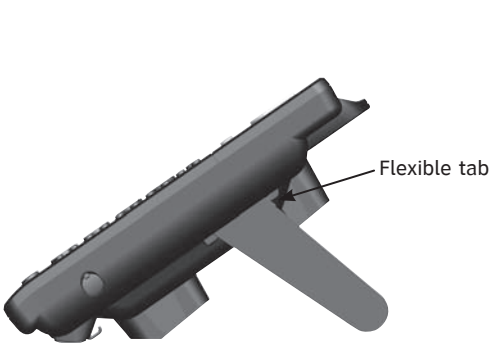

Option 1: Low tabletop position



Option 2: High tabletop position

Installation options

3. Plug the coiled handset cord into the handset and the telephone base. Plug the small end of the power adapter cord into the power jack on the back of the telephone base.
4. Plug the telephone line cords into the wall jacks.

Option 1: If you have a single two-line wall jack, use only the black telephone line cord (4-conductor).

Plug one end of the black telephone line cord into the jack labeled **LINE 1/L1+L2** on the back of the telephone base. Plug the large end of the power adapter into an electrical outlet not controlled by a wall switch.

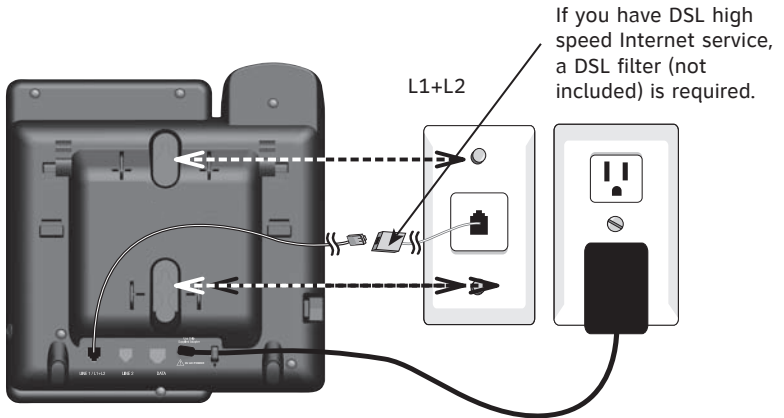

Option 2: If you have two separate one-line wall jacks, use both telephone line cords.

Plug one end of the clear telephone line cord into the jack labeled **LINE 1/L1+L2** on the back of the telephone base. Plug one end of the black telephone line cord into the jack labeled **LINE 2**. Plug the other end of the clear telephone line cord and the other end of the black telephone line cord into the wall jacks.

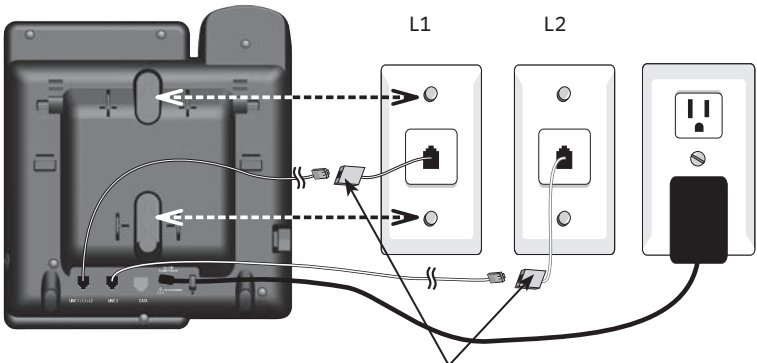

Installation options

5. Wrap the telephone line cord as show below. Mount the telephone on the mounting plate until it is held securely into position. Plug the large end of the power adapter into an electrical outlet not controlled by a wall switch.

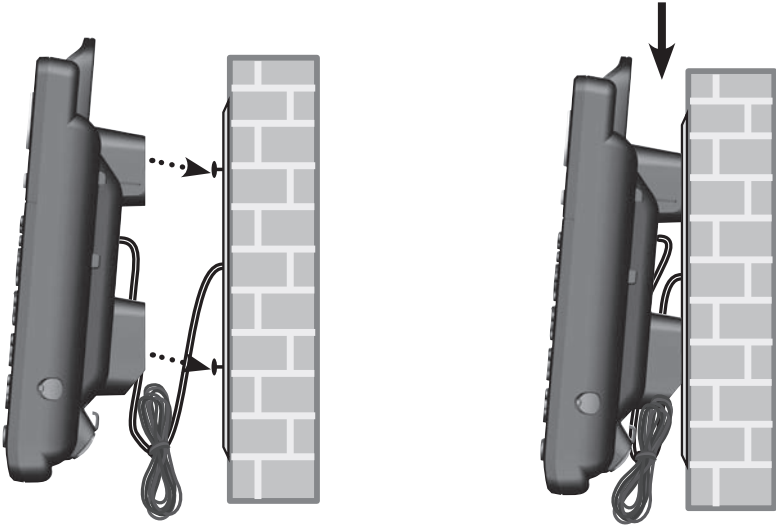

Wall to tabletop installation

To return the telephone base from wall installation to tabletop position:

1. Unwrap the telephone line cord. Remove the telephone base from the wall. Unplug the telephone line cord from the telephone wall jack and the power adapter cord from the electrical outlet.

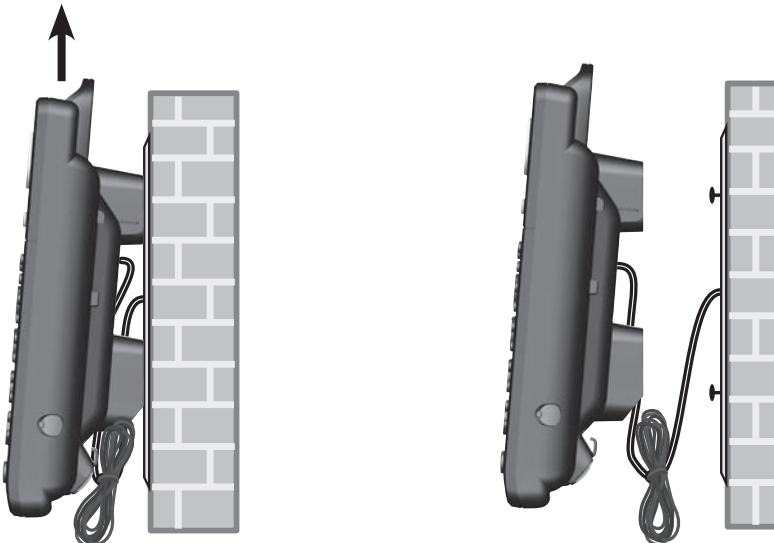

Installation options

2. Hold down the switch hook on the telephone base, then slide the handset tab upwards to remove it from the slot. Rotate the handset tab 180° degrees. Push the handset tab down into the slot until it locks into position.

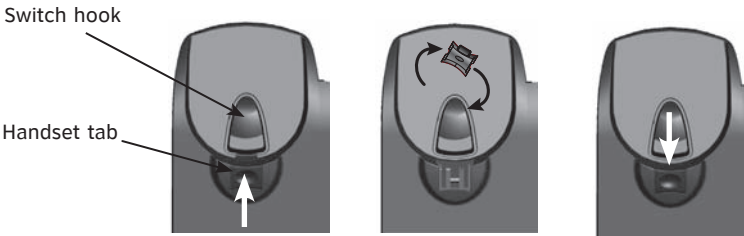

3. Follow the steps in **Telephone base installation** on pages 4-6 to install your telephone for tabletop use.

Optional headset

You can use this telephone hands free when you install any industry standard 2.5mm corded telephone headset (purchased separately). The telephone plays an error tone if you press **HEADSET** when a headset is not plugged into the headset jack.

For best results, use an AT&T 2.5mm headset. To order an AT&T 2.5mm headset, visit our website at **www.telephones.att.com** or call **1 (800) 222-3111**. In Canada, dial **1 (866) 288-4268**.

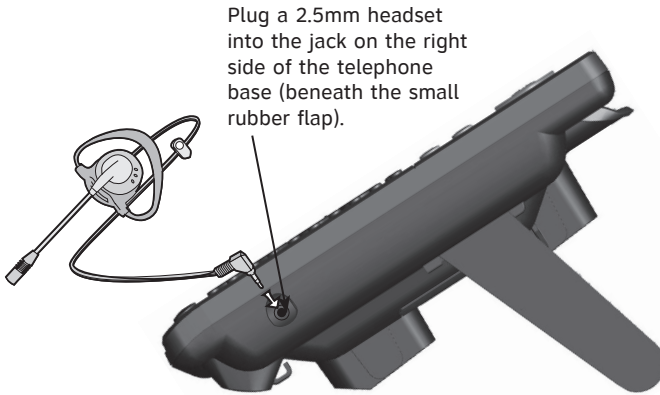

Directory card

Use the directory card to record the names of the speed dial numbers you stored.

To write names on the directory card:

1. Remove the clear plastic cover by inserting the tip of a small item such as a paperclip into the hole at the top edge of the cover.
2. Pull out the directory card.
3. Write the information on the directory card.
4. Replace the directory card and the plastic cover.

To change the directory card:

1. Follow Steps 1 and 2 above to remove the old directory card.
2. Insert the new directory card and replace the plastic cover.



Telephone settings

Menu overview

Use the menus to change the telephone settings.

1. When the telephone is idle, press **MENU/ENTER** to enter the main menu.
2. Press ▼ or ▲ to scroll to the feature to be changed. Press **MENU/ENTER**.
3. Press ▼ or ▲ to scroll to the desired settings.
4. Press **MENU/ENTER** to save your selection. The telephone plays a confirmation tone and returns to the previous menu. To exit without making changes, press **CANCEL**.

-OR-

Press and hold **CANCEL** to return to idle mode.



NOTE: If no key is pressed within 30 seconds, the telephone automatically returns to idle mode.

Menu structure

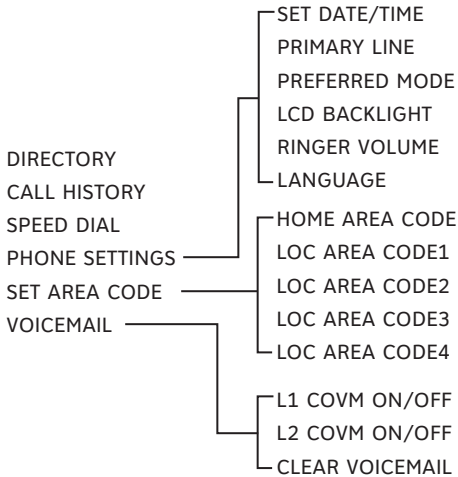

Telephone settings

Set date and time

If you subscribe to a caller ID service provided by your telephone service provider, the date, month and time are set automatically with each incoming call.

1. When the telephone is idle, press **MENU/ENTER**.
2. Press **▼** or **▲** to scroll to **PHONE SETTINGS**.
Press **MENU/ENTER**.
3. Press **MENU/ENTER** to select **SET DATE/TIME**.
4. Use the dialing keys to enter the correct date and time. To enter a number that is less than 10, enter a 0 before the digit. Press **CID/◀** or **▶/DIR** to move the cursor to the left or right.

```
PHONE SETTINGS  ◀▶
▶SET DATE/TIME
PRIMARY LINE
PREFERRED MODE
```

```
SET DATE/TIME  ◀▶
_/_/_: _: _ AM
MM/DD HH/MM
```

-OR-

Press **▼** or **▲** to scroll to the desired digit. Press **CID/◀** or **▶/DIR** to move the cursor to the left or right.

```
SET DATE/TIME  ◀▶
01/01 12:01 AM
MM/DD HH/MM
```

5. Press **▼** or **▲** to scroll to **AM** or **PM**.
6. Press **MENU/ENTER** to save. The telephone plays a confirmation tone and returns to the previous menu.



NOTE: The telephone plays an error tone if you enter an invalid date or time.

Set the primary line

Use this feature to select the default telephone line to be used when you make calls. The primary line is set to **LINE1** by default.

1. When the telephone is idle, press **MENU/ENTER**.
2. Press **▼** or **▲** to scroll to **PHONE SETTINGS**.
Press **MENU/ENTER**.
3. Press **▼** or **▲** to scroll to **PRIMARY LINE**.
Press **MENU/ENTER**.
4. Press **▼** or **▲** to scroll to **LINE1** or **LINE2**.
5. Press **MENU/ENTER** to save. The telephone plays a confirmation tone and returns to the previous menu.

```
PHONE SETTINGS  ◀▶
SET DATE/TIME
▶PRIMARY LINE
PREFERRED MODE
```

```
PRIMARY LINE  ◀▶
▶LINE1
LINE2
```

Telephone settings

Choose the preferred mode

You can set the preferred mode to speakerphone or headset. Your selection is used automatically when dialing a number from the directory, redial or call history without lifting the handset. Your selection is also used for speed dialing when auto speaker is set to **On** (see **Turn auto speaker on or off on page 29**). If a corded headset is not plugged in, the speakerphone is used automatically. The preferred mode is set to **SPEAKERPHONE** by default.

To change the setting:

1. When the telephone is idle, press **MENU/ENTER**.
2. Press ▼ or ▲ to scroll to **PHONE SETTINGS**.
Press **MENU/ENTER**.
3. Press ▼ or ▲ to scroll to **PREFERRED MODE**.
Press **MENU/ENTER**.
4. Press ▼ or ▲ to scroll to **SPEAKERPHONE** or **HEADSET**.
5. Press **MENU/ENTER** to save. The telephone plays a confirmation tone and returns to the previous menu.

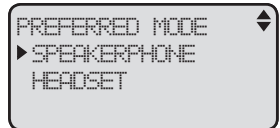
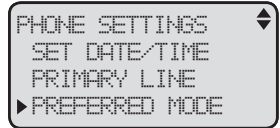

LCD backlight

Use this feature to turn the LCD backlight on or off.

1. When the telephone is idle, press **MENU/ENTER**.
2. Press ▼ or ▲ to scroll to **PHONE SETTINGS**.
Press **MENU/ENTER**.
3. Press ▼ or ▲ to scroll to **LCD BACKLIGHT**.
Press **MENU/ENTER**.
4. Press ▼ or ▲ to scroll to **ON** or **OFF**.
5. Press **MENU/ENTER** to save. The telephone plays a confirmation tone and returns to the previous menu.

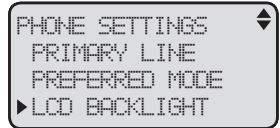

Telephone settings

Ringer volume

You can set the ringer volume level (1-7) or turn the ringer off.

1. When the telephone is idle, press **MENU/ENTER**.
2. Press **▼** or **▲** to scroll to **PHONE SETTINGS**. Press **MENU/ENTER**.
3. Press **▼** or **▲** to scroll to **RINGER VOLUME**. Press **MENU/ENTER**.
4. Press **▼** or **▲** to scroll to the desired line (**LINE1&2**, **LINE1** or **LINE2**). Press **MENU/ENTER**.
5. Press **▼** or **▲**, **VOL+** or **-VOL** to adjust the ringer volume for the selected line.
6. Press **MENU/ENTER** to save. The telephone plays a confirmation tone and returns to the previous menu.



NOTES:

- Pressing **VOL+** or **VOL-** when the telephone is idle adjusts the ringer volume for both lines.
- When a line is ringing, press **VOL+** or **VOL-** to adjust the ringer volume of that line temporarily. The next call will ring at the preset volume.
- If the ringer for either or both lines is muted, **Ringer off** for the corresponding line or both lines (**L1**, **L2** or **L1&2**) appears on the screen when the telephone is idle or there is an incoming call.

Language

Use this feature to change the display language that is used in all menus and screens. This telephone is set to use **ENGLISH** for display by default.

1. When the telephone is idle, press **MENU/ENTER**.
2. Press **▼** or **▲** to scroll to **PHONE SETTINGS**. Press **MENU/ENTER**.
3. Press **▼** or **▲** to scroll to **LANGUAGE**. Press **MENU/ENTER**.
4. Press **▼** or **▲** to scroll to **ENGLISH**, **FRANÇAIS** or **ESPAÑOL**.
5. Press **MENU/ENTER** to save. The telephone plays a confirmation tone and returns to the previous menu.

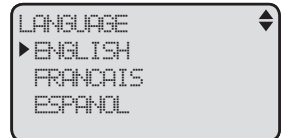
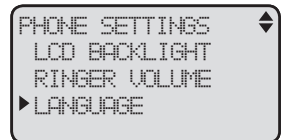

Telephone settings

Set home and local area codes

If you dial seven digits to make a local call (no area code required), enter your area code into the telephone as the home area code. When you receive a call from within your home area code, the caller ID history only displays the seven digits of the telephone number, and when you dial from the caller ID history, only seven digits are dialed.

This feature makes it easy for you to place a call from the caller ID history. If you must dial 10 digits (area code + telephone number) to make a local call, do not program the home area code. Then, if you receive a call from within your area code, the screen displays the 10 digits of the telephone number, and when you dial from the caller ID history, all 10 digits will be dialed.

1. When the telephone is idle, press **MENU/ENTER**.
2. Press ▼ or ▲ to scroll to **SET AREA CODE**.
Press **MENU/ENTER**.
3. Press ▼ or ▲ to scroll to **HOME AREA CODE** or **LOC AREA CODE1 - LOC AREA CODE4**.
Press **MENU/ENTER**.
4. Use the dialing keys to enter a three-digit area code.
 - Press **CID/◀** or **▶/DIR** to scroll to the digit you want to edit.
 - Press **REMOVE** to backspace and delete a digit.
5. Press **MENU/ENTER** to save. The telephone plays a confirmation tone and returns to the previous menu.

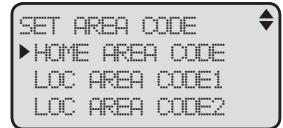
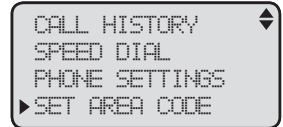

Voicemail indicator settings

Voicemail indicator

If you subscribe to voicemail service offered by your telephone service provider, this feature provides a visual indication when you have new voicemail messages on either line. **VOICE MAIL** displays and the corresponding line blinks on the screen to indicate there are new voicemail messages on that line.



Clear voicemail indication

After you have listened to all new voicemail messages, the indicators turn off automatically.

Use the clear voicemail feature when the telephone indicates that there is new voicemail when there is none (for example, when you have accessed your voicemail while away from home). The clear voicemail feature only turns off the indicators; it does not delete your voicemail messages. As long as you have new voicemail messages, your telephone service provider continues to send the signal that turns on the indicator.

To manually turn off the indicator, follow the steps below.

1. When the telephone is idle, press **MENU/ENTER**.
2. Press ▼ or ▲ to scroll to **VOICE MAIL**.
Press **MENU/ENTER**.
3. Press ▼ or ▲ to scroll to **CLEAR VOICEMAIL**.
Press **MENU/ENTER**.
4. Press ▼ or ▲ to scroll to **LINE1&2**, **LINE1**, or **LINE2**.
5. Press **MENU/ENTER** to save. The telephone plays a confirmation tone and returns to the previous menu.

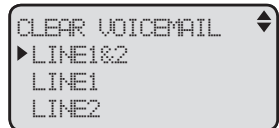
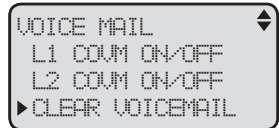
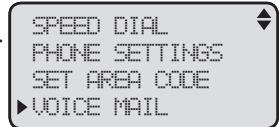

Voicemail indicator settings

Turn **COVM** (central office voicemail) on or off

If you subscribe to voicemail service with your telephone service provider, turn on the **COVM** feature for that telephone line. If you do not subscribe to voicemail service or want to disable the indicator, turn off the **COVM** feature.

1. When the telephone is idle, press **MENU/ENTER**.
2. Press ▼ or ▲ to scroll to **VOICE MAIL**. Press **MENU/ENTER**.
3. Press ▼ or ▲ to scroll to **L1 COVM ON/OFF** or **L2 COVM ON/OFF**. Press **MENU/ENTER**.
4. Press ▼ or ▲ to scroll to **ON** or **OFF**.
5. Press **MENU/ENTER** to save. The telephone plays a confirmation tone and returns to the previous menu.

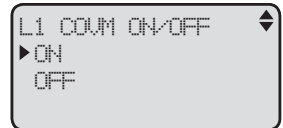
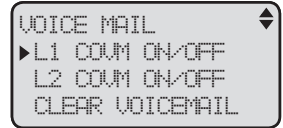

Basic operation

By default, the telephone is set to use line 1 for making calls. To change the primary line, see **Set the primary line** on page 14. When you answer a call, the telephone automatically selects the ringing line.

Making, answering or ending a call

To make a call with the speakerphone:

1. Press **SPEAKER**  to use the primary line.

-OR-

To override automatic line selection, press **SPEAKER** , then press **LINE 1** or **LINE 2**.

-OR-

If you choose **SPEAKERPHONE** in **Choose the preferred mode** (see page 15), press **LINE 1** or **LINE 2** directly to activate the speakerphone.

2. Wait for a dial tone, then dial the telephone number. The screen displays the elapsed time as you talk (in hours, minutes and seconds).
3. Press **SPEAKER**  to hang up.

To make a call with the handset:

1. Lift the handset to use the primary line.

-OR-

Lift the handset, then press **LINE 1** or **LINE 2** to override automatic line selection.

2. Wait for a dial tone, then dial the number.
3. Place the handset on the telephone base to hang up.

To make a call with the corded headset:

Make sure the corded headset is connected to the telephone base (see page 12).

1. Press **HEADSET** on the telephone base to use the primary line.

-OR-

Press **HEADSET**, then press **LINE 1** or **LINE 2** to override automatic line selection.

-OR-

If you chose **HEADSET** in **Choose the preferred mode** (see page 15), press **LINE 1** or **LINE 2** directly to activate the headset.

2. Wait for a dial tone, then dial the number.
3. Press **HEADSET** to hang up.



Elapsed time

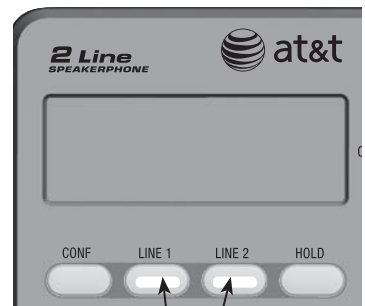

LINE buttons

Basic operation

To answer a call:

- Lift the handset, or press **SPEAKER**  or **HEADSET**.

-OR-

Press the **LINE** button of the ringing line to answer the call with the preferred mode (see **Choose the preferred mode** on page 15).

On hook dialing (predialing)

1. Use the dialing keys to enter a telephone number. Press **REMOVE** to make corrections when entering the telephone number.
2. Lift the handset, or press **SPEAKER**  or **HEADSET**.

-OR-

Press **LINE 1** or **LINE 2** to override automatic line selection and dial the number using your preferred mode (see **Choose the preferred mode** on page 15).

Clearspeak™ dial-in-base speakerphone

During a call using the handset, press **SPEAKER** , then hang up the handset. This allows you to use the telephone hands free and lets more people participate in the conversation.

Switching between the handset, headset and speakerphone

To switch from the handset to speakerphone:

While on a call using the handset, press **SPEAKER** , then hang up the handset.

To switch from the handset to headset:

While on a call using the handset, press **HEADSET** (make sure a headset is firmly plugged in), then hang up the handset.

To switch from the speakerphone to handset:

While on a call using the speakerphone, lift the handset.

To switch from the speakerphone to headset:

While on a call using the speakerphone, press **HEADSET** (make sure a headset is firmly plugged in).

To switch from the headset to speakerphone:

While on a call using the headset, press **SPEAKER** .

To switch from the headset to handset:

While on a call using the headset, lift the handset.

Basic operation

Redial

The last five telephone numbers dialed (up to 24 digits) are stored in the redial memory.

To dial one of the five most recently dialed numbers:

1. When the telephone is idle, press **REDIAL** to enter the redial list and display the most recently called numbers.
2. Press ▼ or ▲ to scroll to the desired number.
3. Lift the handset, or press **SPEAKER**  or **HEADSET**.

-OR-

Press **LINE 1** or **LINE 2** to override automatic line selection and dial the number using your preferred mode (see **Choose the preferred mode** on page 15).

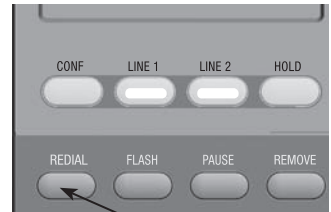

REDIAL

To dial the last number dialed:

1. Lift the handset, or press **SPEAKER**  or **HEADSET**.

-OR-

Press **LINE 1** or **LINE 2** to override automatic line selection.

2. Press **REDIAL** to dial the last number dialed.

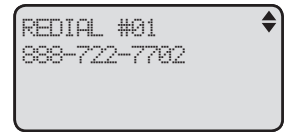

To delete a redial entry:

1. When the telephone is idle, press **REDIAL** to enter the redial list and display the most recently called numbers.
2. Press ▼ or ▲ to scroll to the desired number.
3. Press **REMOVE** to delete the displayed entry. The screen displays **REMOVED** with a confirmation tone.



NOTE: If there is no number stored in the redial memory when you press **REDIAL**, there is an error tone.

Options while on calls

Volume control

You can set the listening volume for the handset and headset to one of four levels, or one of eight levels for the speakerphone. When you are on a call, press **VOL+** to increase the handset, speakerphone or headset listening volume. Press **VOL-** to decrease the listening volume. There are four beeps when you reach the minimum or maximum level.

Flash/call waiting

If you subscribe to call waiting service with your telephone service provider (see **About caller ID** on page 35), you hear a beep if someone calls while you are already on a call.

- Press **FLASH** to put your current call on hold and take the new call.
- Press **FLASH** at any time to switch back and forth between calls.

Mute

Use this feature during a telephone conversation to silence the microphone. You can hear the other party, but the other party cannot hear you.

To mute a call:

- During a call, press **MUTE**. When mute is on, the **MUTE** light turns on and the screen displays **MUTE**.

To take a call off mute:

- Press **MUTE** again and resume speaking.



NOTE: The mute function cancels when you change lines, put a call on hold, start a conference call or switch between the handset, headset and speakerphone.

Hold

Use this feature to hold one or both lines.

To put a call on hold:

- While on a call, press **HOLD**. The **LINE** indicator for that line flashes slowly to indicate the line is on hold.

If you are using the speakerphone, the speakerphone turns off automatically when you press **HOLD**.

To release hold and return to the call:

- Press the **LINE** button for the call to continue the call using the preferred mode.

-OR-

Press **HOLD** again. The **LINE** indicator for the call remains on steadily when you release hold.

Options while on calls

Switching between lines

Use this feature to switch between lines during a call.

1. While on a call, press the **LINE** button of the line not in use to establish a new call or answer an incoming call on that line. The original line is automatically put on hold.
2. To return to the first call, press the original **LINE** button. The other line is automatically put on hold.

Conference calls

Use this feature to set up a three-party call by using two lines at the same time.

To make a three-way conference call:

1. Make or answer a call.
2. Press the other **LINE** button to establish a new call or answer an incoming call and put the original line on hold.
3. Press **CONF** to begin a three-party conference call. The screen displays **LINE 1 & LINE 2 IN CONFERENCE**.

If the caller on line 2 hangs up during the conference call, the call continues on line 1. However, if the caller on line 1 hangs up, a tone plays. Press the **LINE 2** button to stop the tone and continue the call with line 2.

To place a conference call on hold:

1. While on a conference call, press **HOLD** to hold both lines.
2. Press **CONF** to release hold and continue the conference call.

To talk privately with one caller:

1. Press **HOLD** to hold both lines. Press the desired **LINE** button for the caller you want to speak with.
2. Press **CONF** to continue the conference call.

To drop one line:

- Press the **LINE** button for the caller you want to speak with. The other call is disconnected automatically.

To end a conference call:

- Place the handset on the telephone base to hang up, or press **SPEAKER**  or **HEADSET**.

Options while on calls

Chain dialing

Use this feature to initiate a dialing sequence from numbers stored in the directory, speed dial memory, call history or redial while you are on a call.

Chain dialing can be useful if you wish to dial other numbers (such as bank account numbers or access codes) during a call.

To access a number (up to 24 digits) from the directory while on a call:

1. Press **►/DIR**.

-OR-

Press **MENU/ENTER**. Then press **MENU/ENTER** twice.

2. Press **▼** or **▲** to scroll or press the dialing keys to find the desired entry (see **Searching by name** on page 33).

3. Press **MENU/ENTER** to dial the displayed number.

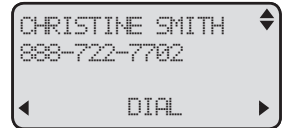

To access a number (up to 24 digits) from the speed dial memory while on a call:

• Press the speed dial key.

-OR-

Press **LOWER**, then press the speed dial key.
The number is dialed automatically.

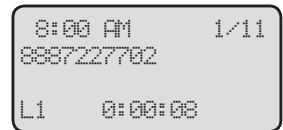

To access a number (up to 24 digits) from the call history while on a call:

1. Press **CID/◀**.

-OR-

Press **MENU/ENTER**, then press **▼** or **▲** to scroll to **CALL HISTORY**. Press **MENU/ENTER**.

2. Press **◀/CID** or **►/DIR** to scroll to **LINE 1**, **LINE 2** or **ALL LINES** to review the call history entries on one or both lines.
Press **MENU/ENTER**.

3. Press **MENU/ENTER** again to select **REVIEW**.

4. Press **▼** or **▲** to scroll to the desired number. Press **MENU/ENTER** twice to dial the displayed number.

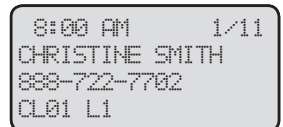

To access the last number dialed (up to 24 digits) while on a call:

• Press **REDIAL**. The number is dialed automatically.

Line power mode (no AC power)

This telephone provides minimal functionality during a power failure. When AC power is not available, the screen is blank and many telephone features do not function. Only touch-tone dialing and handset volume adjustment are supported. The telephone uses power from the telephone line to enable you to make and answer calls on **LINE 1** only using only the handset and dialing keys.

To make a call during a power failure

1. Lift the handset and wait for the dial tone. The screen shows **NO AC POWER**.
2. Dial a telephone number using the dialing keys. Wait to hear each key tone and make sure the digit appears on the screen before pressing the next dialing key.

To answer a call during a power failure

- Lift the handset.



NOTES:

- The screen does not show incoming caller ID information during a power failure.
- If the telephone loses power during a call, the screen display may become unstable. Try resetting the screen by unplugging the power adapter and plugging it back in after a few seconds, or after power returns following a power failure.

Speed dial memory overview

This telephone has 18 speed dial locations for storing telephone numbers. You can store up to 24 digits in each location. If the number you stored is over 24 digits, the screen displays **ONLY 24 DIGITS ARE ALLOWED**.

Only the first nine locations can be accessed by directly pressing the speed dial keys. To access the next nine locations, press **LOWER** and then the speed dial key for the desired location.

You may wish to write the names or telephone numbers of speed dial entries on the directory card, using the white spaces for the first nine speed dial locations and the gray spaces for the lower nine speed dial locations.

If you need to replace your directory card, see **Directory card** on page 12.

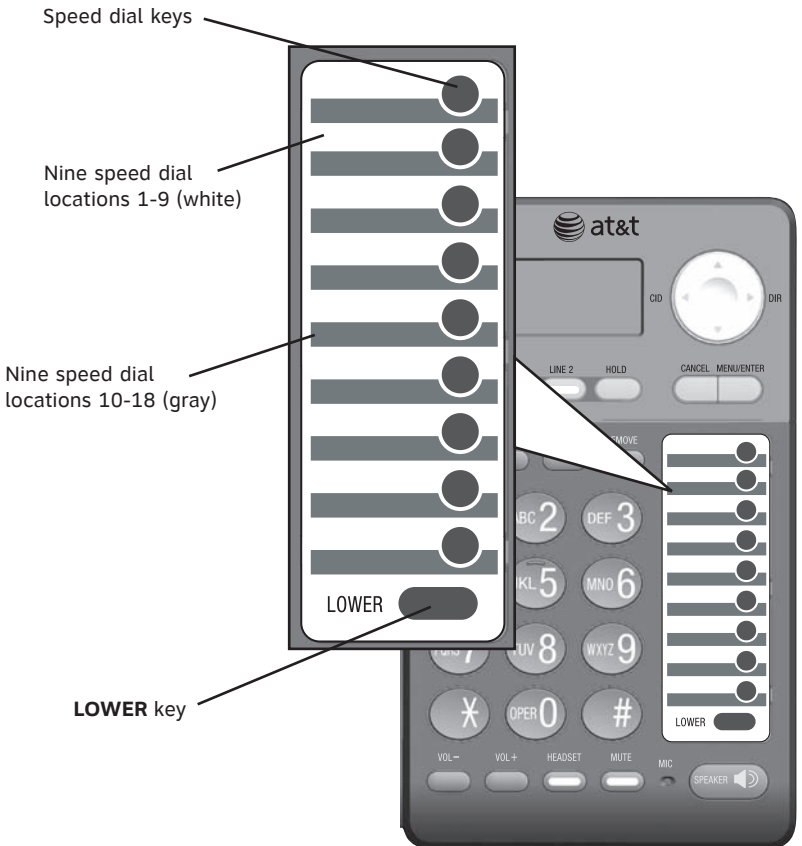

Speed dial operation

Storing a number in a speed dial location

Use the following steps to store a telephone number in the desired speed dial memory location.

1. When the telephone is idle, press **MENU/ENTER**.
2. Press ▼ or ▲ to scroll to **SPEED DIAL**. Press **MENU/ENTER**.
3. Press ▼ or ▲ to scroll to **PROGRAM**. Press **MENU/ENTER**.
4. Use the dialing keys to enter the telephone number (up to 24 digits). **PRESS SPDIAL KEY TO SAVE** moves on the screen.
 - Press **CID/◀** or **▶/DIR** to move the cursor to the left or right.
 - Press **REMOVE** to backspace and delete a digit.
 - Press **PAUSE** to insert a two-second dialing pause. **P** appears on the screen.
5. Press the desired speed dial key.

-OR-

Press **LOWER**, then press the desired speed dial key. The telephone plays a confirmation tone and the screen displays **STORED TO SPEED DIAL #01** if you store the number to speed dial location 1.

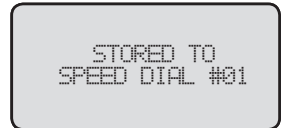
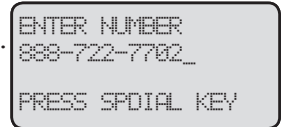
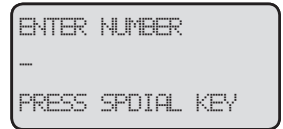
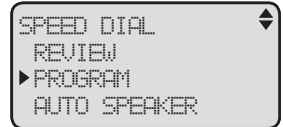
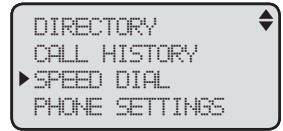

NOTE: If the speed dial location you selected is occupied, the new telephone number replaces the old one. Take caution not to replace entries you do not wish to delete.

Reviewing a speed dial number

If **Auto speaker** is turned on (see **Turn auto speaker on or off** on page 29):

1. When the telephone is idle, press **MENU/ENTER**.
2. Press ▼ or ▲ to scroll to **SPEED DIAL**. Press **MENU/ENTER**.
3. Press ▼ or ▲ to scroll to **REVIEW**. Press **MENU/ENTER**.
4. Press ▼ or ▲ to scroll through the speed dial numbers.

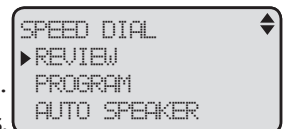

If **Auto speaker** is turned off (see **Turn auto speaker on or off** on page 29), when the telephone is idle:

- Press the desired speed dial key.

-OR-

Press **LOWER**, then press the desired speed dial key to review the number.

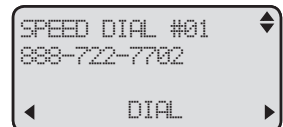

Speed dial operation

Editing a speed dial number

Follow the steps below to edit a speed dial number.

1. Follow the steps in **Reviewing a speed dial number** on page 28 to display a speed dial number.
2. Press **CID**/**◀** or **▶**/**DIR** to scroll to **EDIT**.
Press **MENU/ENTER**.
3. Use the dialing keys to edit the telephone number.
 - Press **CID**/**◀** or **▶**/**DIR** to move the cursor to the left or right.
 - Press **REMOVE** to backspace and delete a digit.
 - Press **PAUSE** to insert a two-second dialing pause. **P** appears on the screen.
4. Press **MENU/ENTER** to save the number. The screen displays **STORED** with a confirmation tone.



Turn auto speaker on or off

If you set auto speaker to on and you press a speed dial key with a stored number, the telephone automatically dials the number using the preferred mode you set (see **Choose the preferred mode** on page 15). The auto speaker feature is set to off by default. To change the setting:

1. When the telephone is idle, press **MENU/ENTER**.
2. Press **▼** or **▲** to scroll to **SPEED DIAL**.
Press **MENU/ENTER**.
3. Press **▼** or **▲** to scroll to **AUTO SPEAKER**.
Press **MENU/ENTER**.
4. Press **▼** or **▲** to scroll to **ON** or **OFF**.
5. Press **MENU/ENTER** to save. The telephone plays a confirmation tone and returns to the previous menu.

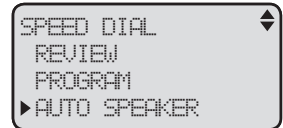
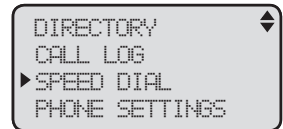

Speed dial operation

Dialing a speed dial number

If **Auto speaker** is turned on, numbers will be dialed using the preferred mode (see **Choose the preferred mode** on page 15). If the preferred mode is **Headset** but no headset is connected, the number will be dialed using the speakerphone.

- Press the desired speed dial key.

-OR-

Press **LOWER**, then press the desired speed dial key. The number is dialed automatically.

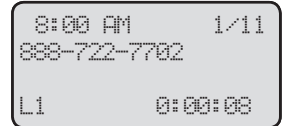

If **Auto speaker** is turned off, or if you want to use the handset or headset regardless of the **Auto speaker** programming:

1. Lift the handset, or press **SPEAKER**  or **HEADSET**.

-OR-

Press **LINE 1** or **LINE 2** to override automatic line selection.

2. Press the desired speed dial key.

-OR-

Press **LOWER**, then press the desired speed dial key.

The number is dialed automatically.

To dial the speed dial number while reviewing:

1. Follow the steps in **Reviewing a speed dial number** on page 28 to display a speed dial number.
2. Lift the handset or press **SPEAKER**  or **HEADSET**.

-OR-

To dial the number using your preferred mode (see **Choose the preferred mode** on page 15):

- Press **MENU/ENTER**.
- Press **LINE 1** or **LINE 2** to override automatic line selection.

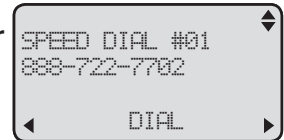

Deleting a speed dial number

1. Follow the steps in **Reviewing a speed dial number** on page 28 to display a speed dial number.
2. Press **REMOVE** to delete the number. The screen displays **REMOVED**. Once a number is deleted, it cannot be retrieved.

About the directory

Directory memory capacity

The directory of this telephone can store up to 100 entries, with a maximum of 16 alphanumeric characters (including spaces) for names and 24 digits for telephone numbers. If the number you entered is over 24 digits, the screen shows **ONLY 24 DIGITS ARE ALLOWED**. A convenient search feature can help you quickly find and dial numbers (see **Searching by name** on page 33).

If you try to add a new contact and there are already 100 entries, the screen shows **MEMORY FULL**. You cannot store a new number until you delete one. If you try to review the directory entries when there are none, the screen displays **DIRECTORY EMPTY**.

Character chart

Use the dialing keys and the chart below to enter a name (up to 16 characters). Each press of a particular key causes the characters to be displayed in the following order:

Dial Key	Characters by number of key presses								
	1	2	3	4	5	6	7	8	9
1	,	_	'	,	&	.	()	1
2	A	B	C	2					
3	D	E	F	3					
4	G	H	I	4					
5	J	K	L	5					
6	M	N	O	6					
7	P	Q	R	S	7				
8	T	U	V	8					
9	W	X	Y	Z	9				
0	0								
*	*								
#	#								

Create directory entries

Creating a directory entry

Use the following steps to store a name and number in the directory.

1. When the telephone is idle, press **MENU/ENTER**.
2. Press **MENU/ENTER** to select **DIRECTORY**.
3. Press **▼** or **▲** to scroll to **ADD CONTACT**.
Press **MENU/ENTER**.
4. Use the dialing keys to enter a number (up to 24 digits).
 - Press **CID/◀** or **▶/DIR** to move the cursor to the left or right.
 - Press **REMOVE** to backspace and delete a digit.
 - Press **PAUSE** to insert a two-second dialing pause. **P** appears on the screen.

-OR-

To copy a number from the redial list, press **REDIAL** to enter the redial memory. Press **▼** or **▲** to scroll to the desired number. Press **MENU/ENTER**.

5. Press **MENU/ENTER** to move on to enter the name. Use the dialing keys (see **Character chart** on page 31) to enter the name (up to 16 characters).
 - Press **CID/◀** or **▶/DIR** to move the cursor to the left or right.
 - Press **REMOVE** to backspace and delete characters.
6. Press **MENU/ENTER** to save the entry. The screen displays **STORED TO DIR**, then returns to the previous menu. To exit without making changes, press **CANCEL**.

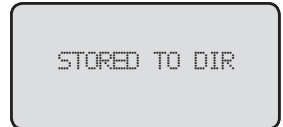
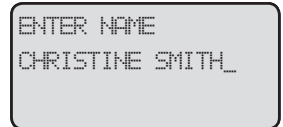
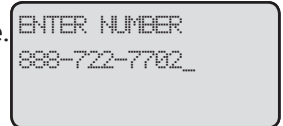

Review the directory

Reviewing directory entries

Use the following steps to review directory entries.

1. Press **▶/DIR** to enter the directory.

-OR-

- a. When the telephone is idle, press **MENU/ENTER**.
- b. Press **MENU/ENTER** to select directory.
- c. Press **MENU/ENTER** again to select **REVIEW**.

2. Press **▼** or **▲** to scroll through the directory entries. Press and hold **▼** or **▲** to scroll continuously.

-OR-

Press the dialing keys to search a number by name (see **Searching by name** below). If no name matches the character you pressed, the screen displays **No Entries FOR "X"** (X represents for the character of the key you pressed).

3. Press and hold **CANCEL** to return to idle mode.

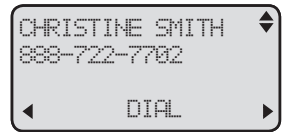
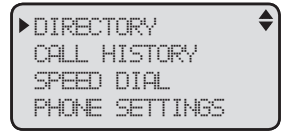

Searching by name

Follow the steps below to search for directory entries by name.

1. Follow the steps in **Reviewing directory entries** above to enter the directory.
2. When in the directory, press the dialing keys (**2-9**) to start a name search. The directory shows the first name beginning with the first letter on the dialing key (if there is one).
3. To see other names starting with the letters on the same dialing key, keep pressing the key. The names appear in alphabetical order.

For example, if you have the names **JENNIFER**, **JESSIE**, **KEVIN** and **LINDA** in your directory:

- If you press **5 (JKL)** once, you see **JENNIFER**. When **JENNIFER** displays, press **▼**, you see **JESSIE**.
- If you press **5 (JKL)** twice, you see **KEVIN**.
- If you press **5 (JKL)** three times, you see **LINDA**.
- If you press **5 (JKL)** four times, you see **No Entries FOR "5"**.
- If you press **5 (JKL)** five times, you see **JENNIFER** again.



NOTE: If there is no name matching the first letter of the key you press, the directory shows a name matching the following letters of the key.

Dial, delete or edit directory entries

To dial, delete or edit a directory entry (name and number), the entry must be displayed on the handset. Use **Reviewing directory entries** on page 33 to show an entry.

Display dial

To dial a displayed number from the directory:

- Lift the handset, or press **SPEAKER**  or **HEADSET**.

-OR-

To dial the number using your preferred mode (see **Choose the preferred mode** on page 15):

- Press **MENU/ENTER**.
- Press **LINE 1** or **LINE 2** to override automatic line selection.

Deleting directory entries

To delete a displayed number from the directory:

1. Press **REMOVE** to delete the entry. The screen displays **DELETE CONTACT?**
2. Press **MENU/ENTER** to confirm. The screen shows **REMOVED!** and then the next directory entry if any. You cannot retrieve an entry once you have deleted it.

Editing directory entries

To edit a displayed number from the directory:

1. Press **CID/◀** or **▶/DIR** to scroll to **EDIT**. Press **MENU/ENTER**. Press the dialing keys to edit the number.
 - Press **REMOVE** to backspace and delete a digit.
 - Press **CID/◀** or **▶/DIR** to move the cursor to the left or right.
 - Press **PAUSE** to insert a two-second dialing pause. **P** appears on the screen.
2. Press **MENU/ENTER** to move on to edit the name. Press the dialing keys to edit.
 - Press **REMOVE** to backspace and delete a character.
 - Press **CID/◀** or **▶/DIR** to move the cursor to the left or right.
3. Press **MENU/ENTER** to save the entry. The screen displays **STORED TO DIR** with a confirmation tone.

About caller ID

This product supports caller ID services offered by most telephone service providers. Caller ID allows you to see the name, number, date and time of calls. The available caller ID information will appear after the first or second ring.

Information about caller ID with call waiting

Caller ID with call waiting lets you see the name and telephone number of the caller before answering the telephone, and while on another call.

There are fees for caller ID services. In addition, this service might be called different names (such as caller ID with visual call waiting) by different telephone service providers and might not be available in all areas.



It might be necessary to change your telephone service to use this feature. Contact your telephone service provider if:

- You have both caller ID and call waiting, but as separate services (you might need to combine these services).
- You have only caller ID service, or only call waiting service.
- You don't subscribe to caller ID or call waiting services.

This product can provide information only if both you and the caller are in areas offering caller ID service and if both telephone companies use compatible equipment. The time and date are from the telephone service provider along with the call information.

Caller ID information might not be available for every incoming call. Callers may intentionally block their names and/or telephone numbers.



NOTES:

- You can use this product with regular caller ID service, or you can use this product's other features without subscribing to caller ID or combined caller ID with call waiting service.
- The format of telephone numbers displayed depends on the home and local area codes you set (see **Set home and local area codes** on page 17).

About caller ID

How caller ID history (call log) works

The telephone stores caller ID information for the last 99 incoming calls. Entries are stored in reverse chronological order. The telephone deletes the oldest entry when the log is full to make room for new calls.

If you answer a call before the information appears on the screen, it does not show in the caller ID history.

Review the caller ID history to determine who called, return the call, or copy the caller's name and number into your directory or speed dial memory.

LX: XX NEW CALLS appears if there are new call history entries that have not been reviewed on that line (X is the line number and XX is the number of missed calls). **CALL HISTORY EMPTY** appears if there are no records in the call log.

The time and date of the call and the caller's name and telephone number are included in the display.

Caller ID information appears on the screen as the telephone rings, or until the caller hangs up, or until the call ends.

If you subscribe to caller ID service, the time and date are automatically reset with the incoming call. You can also set the time and date manually (see **Set date and time** on page 14).

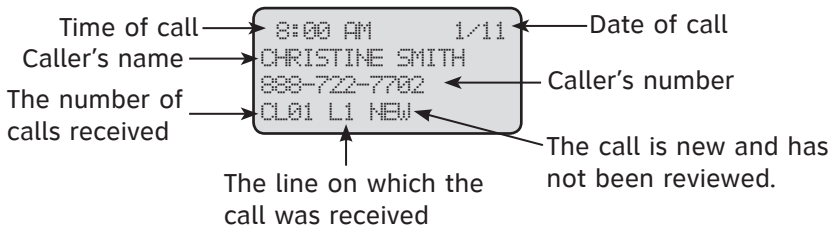

NOTES:

- The caller ID information might not be available for every incoming call. Callers might intentionally block their names and/or telephone numbers (see **Reasons for missing caller ID information** on page 41).
- Each entry can have up to 24 digits for the telephone number and 16 characters for the name. If the telephone number has more than 16 digits, only the last 16 digits appear. If the name has more than 16 characters, only the first 16 characters appear.

Caller ID operation

Memory match

If the incoming telephone number matches the last seven digits of the telephone number in your directory, the name that appears on the screen matches the corresponding name in your directory.

For example, if **CHRISTINE SMITH** calls, her name appears as **CHRIS** if this is how you entered it into your directory.



NOTE: The number you see on your caller ID is in the format from the telephone service provider. It usually delivers 10-digit telephone numbers (area code plus telephone number). The telephone system ignores the area code when searching for a match and displays the name of the corresponding number from the directory.

Missed calls indicator

All new or missed call history entries are counted as missed calls. Each time you review a call history entry with **NEW**, the number of missed calls decreases by one. When all the entries in the call log have been reviewed, the missed calls indicator will be removed from the display.

Reviewing call history

1. When the telephone is idle, press **MENU/ENTER**.

-OR-

When the telephone is idle, press **CID/◀** and skip to Step 4.

2. Press **▼** or **▲** to scroll to **CALL HISTORY**.

Press **MENU/ENTER**.

3. Press **▼** or **▲** to scroll to **REVIEW**.

Press **MENU/ENTER**.

4. Press **CID/◀** or **▶/DIR** to select **LINE 1**, **LINE 2** or **All lines** to review the call history entries on the selected line or both lines. Press **MENU/ENTER**.

5. Press **▼** to display entries starting with the most recent call. Press **▼** or **▲** to scroll through the call history entries. Press and hold **▼** or **▲** to scroll continuously.

6. Press and hold **CANCEL** to return to idle mode.

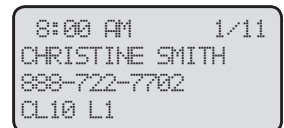
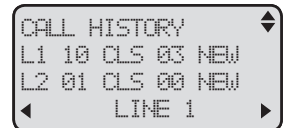
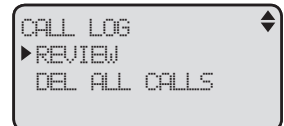
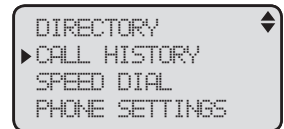

NOTE: When you access the call history with no entries, the screen displays **CALL HISTORY EMPTY**.

Caller ID operation

Dialing options

Although the incoming call history entries have 10 digits (the area code plus the seven-digit number), in some areas, you may need to dial only the seven digits, 1 plus the seven digits, or 1 plus the area code plus the seven digits.



While reviewing the call history, press # (pound key) repeatedly to show different dialing options for local and long distance numbers before dialing or saving the telephone number in the directory.

Press # (pound key)

1-888-722-7702

722-7702

1-722-7702

888-722-7702

Display dial

1. When in the call history (see **Reviewing call history** on page 37), press ▼ or ▲ to scroll to the number you wish to call. Press # (pound key) repeatedly to select the desired dialing format.
2. Lift the handset, or press **SPEAKER** or **HEADSET**.

-OR-

To dial the number using your preferred mode (see **Choose the preferred mode** on page 15):

- Press **MENU/ENTER** twice.
- Press **LINE 1** or **LINE 2** to override automatic line selection.

Deleting call history entries

Delete a specific call history entry:

1. When in the call history (see **Reviewing call history** on page 37), press ▼ or ▲ to scroll to the number you wish to delete.
2. Press **REMOVE** to delete the displayed number.

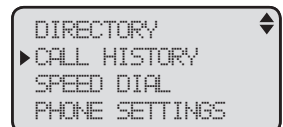

Delete all call history entries:

1. When the telephone is idle, press **MENU/ENTER**.
2. Press ▼ or ▲ to scroll to **CALL HISTORY**. Press **MENU/ENTER**.
3. Press ▼ or ▲ to scroll to **DEL ALL CALLS**.
4. Press **MENU/ENTER**. The screen displays **CONFIRM?**
5. Press **MENU/ENTER** to confirm. The screen displays **ALL DELETED**. Then it automatically returns to the previous menu.

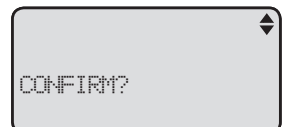

Caller ID operation

Saving a call history entry to the directory

1. When in the call history (see **Reviewing call history** on page 37), press ▼ or ▲ to scroll to the desired entry. Press **MENU/ENTER**.

2. Press **CID/◀** or **▶/DIR** to scroll to **COPY TO DIR**.

-OR-

If you need to add or remove the area code or a 1 at the beginning of the number, do the following:

a. Press **#** (pound key) repeatedly to scroll through the various dialing formats (area code + seven-digit number, 1 + area code + seven-digit number, seven-digit number or 1 + seven-digit number).

b. Press **CID/◀** or **▶/DIR** to scroll to **COPY TO DIR**.

3. Press **MENU/ENTER**. Use the dialing keys to edit the telephone number (up to 24 digits).

- Press **CID/◀** or **▶/DIR** to move the cursor to the left or right.

- Press **REMOVE** to backspace and delete a digit.

- Press **PAUSE** to insert a two-second dialing pause. **P** appears on the screen.

4. Press **MENU/ENTER** to move on to edit the name. Use the dialing keys (see **Character chart** on page 31) to enter the name (up to 16 characters).

- Press **CID/◀** or **▶/DIR** to move the cursor to the left or right.

- Press **REMOVE** to backspace and delete a character.

5. Press **MENU/ENTER** to save the entry. The telephone displays **STORED TO DIR**, plays a confirmation tone and then returns to the call history entry.

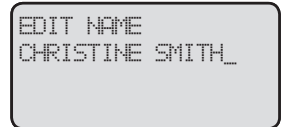
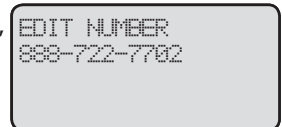
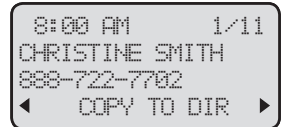

Caller ID operation

Saving a call history entry to a speed dial location

1. When in the call history (see **Reviewing call history** on page 37), press ▼ or ▲ to scroll to the desired entry (up to 24 digits), then press **MENU/ENTER**.

2. Press **CID/◀** or **▶/DIR** to scroll to **COPY TO SPDIAL**.

-OR-

If you need to add or remove the area code or a 1 at the beginning of the number, do the following:

a. Press # (pound key) repeatedly to scroll through the various dialing formats (area code + seven-digit number, 1 + area code + seven-digit number, seven-digit number or 1 + seven-digit number).

b. Press **CID/◀** or **▶/DIR** to scroll to **COPY TO SPDIAL**.

3. Press **MENU/ENTER**. The screen displays **PRESS SPEED DIAL KEY TO SAVE**.

4. Press a desired speed dial key.

-OR-

Press **LOWER** then press a desired speed dial key to store the entry.

The telephone plays a confirmation tone and the screen displays **STORED TO SPEED DIAL# 01** if you store the number in speed dial location 1.

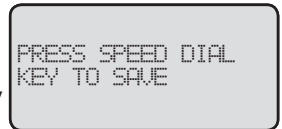
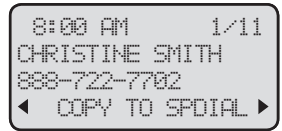

NOTE: If the speed dial memory location you selected is occupied, the screen displays **OVERWRITE SPEED DIAL# X?** (X represents the speed dial location number) Press **MENU/ENTER** to confirm and overwrite, or press **CANCEL** to cancel.

Reasons for missing caller ID information

Screen message	Reason
PRIVATE NAME	The caller prefers not to show the name.
PRIVATE NUMBER	The caller prefers not to show the telephone number.
PRIVATE CALLER	The caller prefers not to show the name and telephone number.
UNKNOWN NAME	The telephone service provider cannot determine the caller's name.
UNKNOWN NUMBER	The telephone service provider cannot determine the caller's telephone number.
UNKNOWN CALLER	The telephone service provider cannot determine the caller's name and number.

Indicator lights and alert tones

Indicator lights

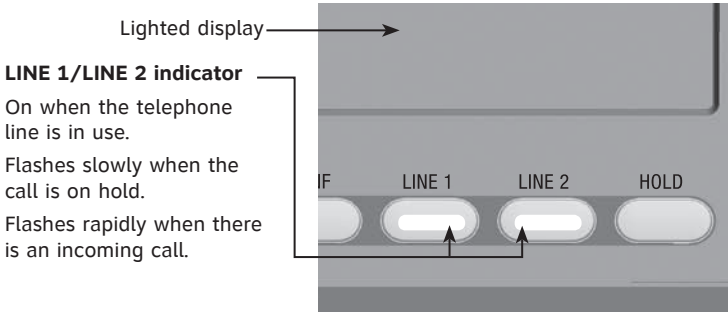

LINE 1/LINE 2 indicator
 On when the telephone line is in use.
 Flashes slowly when the call is on hold.
 Flashes rapidly when there is an incoming call.

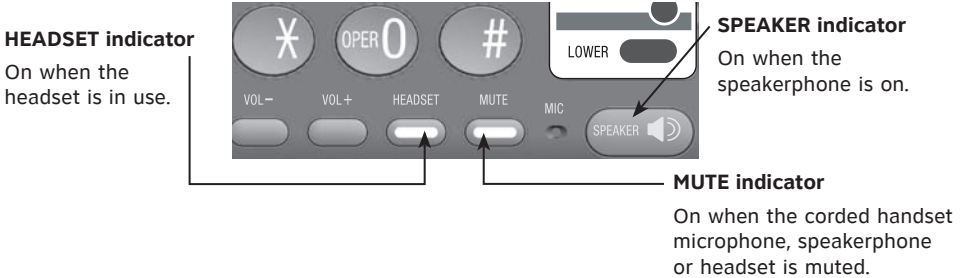

HEADSET indicator
 On when the headset is in use.

SPEAKER indicator
 On when the speakerphone is on.

MUTE indicator
 On when the corded handset microphone, speakerphone or headset is muted.

Alert tones

Confirmation tone (3 ascending beeps)	<ul style="list-style-type: none"> The command has been completed successfully.
Error tone (2 quick beeps)	<ul style="list-style-type: none"> You press REDIAL when the redial list is empty. No headset is plugged into the telephone base when you press HEADSET. The requested task cannot be completed due to missing information or an input error.
Four beeps	<ul style="list-style-type: none"> You press VOL+ or VOL- when the volume has already reached its highest or lowest setting.

Screen display messages

ALL DELETED	All call history entries have been deleted.
CALL HISTORY EMPTY	There are no entries in the call history.
CONF.	Lines 1 and 2 are on a three-way conference call.
DIRECTORY EMPTY	There are no entries in the directory.
LINE 1 & LINE 2 IN CONFERENCE	You have created a three-way conference call.
LOWER SPEED DIAL	You have accessed the LOWER speed dial memory.
LX: IN USE	The telephone on the same line with line X is in use.
LX: ON HOLD	Line X is put on hold.
LX: XX NEW CALLS	XX calls on line X have not been reviewed.
MEMORY FULL	The directory memory is full.
MUTE	You have muted the call.
NO AC POWER	There is no AC power. Check the power adapter connection to the telephone and the electrical wall outlet.
No Entries FOR "X"	There is no name which matches the letter X in the directory.
ONLY 24 DIGITS ARE ALLOWED	The directory entry you entered is over 24 digits.
OVERWRITE SPEED DIAL #X	You replace the speed dial location X with a new speed dial entry.
REMOVED	A redial entry, directory entry or speed dial entry has been deleted.
STORED	You have stored an edited speed dial entry.
STORED TO DIR	The entry has been saved successfully into the directory.
STORED TO SPEED DIAL #X	You have stored a new speed dial entry in the speed dial location X.
VOICE MAIL: LX	There is a new voicemail message on line X.

Troubleshooting

If you have difficulty with your telephone, please try the suggestions below. For customer service, visit our website at **www.telephones.att.com** or call **1 (800) 222-3111**. In Canada, dial **1 (866) 288-4268**.

My telephone does not work at all.

- Make sure the power adapter is securely plugged into an electrical outlet not controlled by a wall switch.
- Make sure you plug the telephone line cord securely and firmly into the telephone jack and the telephone wall jack.
- Unplug the power adapter from the electrical outlet. Wait for approximately 15 seconds, then plug it back in. Allow up to one minute for the telephone to reset.
- Disconnect the telephone base from the telephone wall jack and plug in a working telephone. If that telephone does not work, the problem is probably in the wiring or the telephone service. Call your telephone service provider.

I cannot get a dial tone.

- First, try all suggestions above.
- Make sure you plug the handset cord securely and firmly into the handset jack on the telephone base and the corded handset.
- Your telephone line cord might be malfunctioning. Try installing a new telephone line cord.
- Make sure **HOLD** is not pressed.
- If there is no dial tone when the **HEADSET** key is pressed, make sure a corded headset is firmly connected into the headset jack.
- If you are only using one telephone line, make sure to set it as the primary line (see **Set the primary line** on page 14).
- If the previous suggestions do not work, disconnect the telephone base from the telephone jack and connect to a different telephone. If there is no dial tone on that telephone either, the problem is in your wiring or telephone service. Contact your telephone service provider.

I cannot dial out.

- First try all the suggestions above.
- Make sure there is a dial tone before dialing. The telephone might take a second or two to produce a dial tone. This is normal. Wait an extra second before dialing.
- Check that all the telephones connected to the same telephone line are hung up.

Troubleshooting

- Eliminate any background noise. Noise from a television, radio or other appliances might cause the telephone to not dial out properly. If you cannot eliminate the background noise, first try muting the corded handset before dialing, or dialing from another room with less background noise.
- If other telephones in your building are having the same problem, contact your telephone service provider (charges might apply).

I hear other calls while using my telephone.

- Disconnect the telephone base from the telephone jack, and plug in a different telephone. If you still hear other calls, call your telephone service provider.

My telephone does not ring when I receive a call.

- Make sure that the ringer is not turned off (see **Ringer volume** on page 16).
- Make sure you plug in the telephone line cord securely into the telephone base and the telephone jack. Make sure you plug in the power cord securely.
- There might be too many extension telephones on the telephone line to allow all of them to ring simultaneously. Try unplugging one telephone at a time until the telephones start ringing.
- If other telephones in your building are having the same problem, contact your telephone service provider (charges might apply).
- Test a working telephone at the telephone jack. If another telephone has the same problem, contact your telephone service provider (charges might apply).
- Your telephone line cord might be defective. Try installing a new telephone line cord.

My calls cut in and out while I'm using my corded handset.

- If you are using the handset when this problem occurs, try unplugging the coiled handset cord and firmly plugging it in the handset and telephone base again.
- If you are using the headset, try unplugging it and firmly plugging it in again.
- If you are using the speakerphone, eliminate any background noise. Noise from a television, radio, or other appliances might cause the speakerphone to cut in and out. Try pressing **MUTE** when you are not speaking to eliminate the background noise.
- Disconnect the telephone base from the telephone wall jack and plug in another corded telephone. If calls are still not clear, the problem is probably in the wiring or telephone service. Contact your telephone service provider (charges may apply).

Troubleshooting

- If you subscribe to high-speed Internet service (DSL - digital subscriber line) through your telephone line(s), you must install a DSL filter between each telephone line cord and telephone wall jack (see **Telephone base installation** on pages 5-6). The filter prevents noise and caller ID problems caused by DSL interference. Please contact your DSL service provider for more information about DSL filters.

My caller ID isn't working.

- Caller ID is a subscription service. You must subscribe to this service from your telephone service provider for this feature to work on your telephone base.
- The caller must be calling from an area that supports caller ID.
- Both your and your caller's telephone service provider must use caller ID compatible equipment.
- If you subscribe to high-speed Internet service (DSL - digital subscriber line) through your telephone line(s), you must install a DSL filter between each telephone line cord and telephone wall jack (see **Telephone base installation** on pages 5-6). The filter prevents noise and caller ID problems resulting from DSL interference. Please contact your DSL service provider for more information about DSL filters.

System does not receive caller ID when on a call.

- Make sure you subscribe to caller ID with call waiting features from your telephone service provider. Caller ID feature works only if both you and the caller are in areas offering caller ID service, and if both telephone companies use compatible equipment.

Voicemail appears and L1 and/or L2 flashes on the display.

- Your telephone has voicemail indication. If **Voicemail** appears and **L1** and/or **L2** flashes on the display, then your telephone has received a signal from your telephone service provider that you have a voicemail message on line 1 and/or line 2 waiting for you to retrieve from your telephone service provider. Contact your telephone service provider for more information on how to access your voicemail.

My LCD screen isn't functioning normally.

- When the telephone loses power during a call, the screen may temporarily stop functioning normally and freeze, display text incorrectly or exhibit other unstable behavior. Try resetting the phone by unplugging the power adapter and plugging it back in after a few seconds, or after power returns following a power failure.

Troubleshooting

I subscribe to a nontraditional telephone service that uses my computer to establish connections, and my telephone doesn't work.

- Make sure your computer is powered on.
- Make sure your Internet connection is working properly.
- Make sure that the software is installed and running for your nontraditional telephone service.
- Make sure to plug your USB telephone adapter into a dedicated USB port on your computer. Do not plug into a multiple port USB hub (USB splitter) that is not powered.
- In a few rare instances, the USB port on your computer may not have enough power. In these instances, try using a USB hub with its own external power supply.
- If you are using a firewall, it may prevent access to your nontraditional telephone service. Contact your service provider for more information.

Common cure for electronic equipment.

If the telephone base does not seem to be responding normally, do the following (in the order listed):

- Disconnect the power to the telephone base.
- Wait a few minutes.
- Connect the power to the telephone base.

General product care

To keep your telephone working well and looking good, follow these guidelines:

- Avoid putting it near heating appliances and devices that generate electrical noise (for example, motors or fluorescent lamps).
- DO NOT expose it to direct sunlight or moisture.
- Avoid dropping the telephone or treating it roughly.
- Clean with a soft cloth.
- Never use a strong cleaning agent or abrasive powder because this can damage the finish.
- Retain the original packaging in case you need to ship it at a later date.

Important safety information



This symbol is to alert you to important operating or servicing instructions that may appear in this user's manual. Always follow basic safety precautions when using this product to reduce the risk of injury, fire, or electric shock.

Safety information

- **Read and understand all instructions in the user's manual. Observe all markings on the product.**
- **Avoid using a telephone during a thunderstorm.** There might be a slight chance of electric shock from lightning.
- **Do not use a telephone in the vicinity of a gas leak.** Under certain circumstances, a spark may be created when the adapter is plugged into the power outlet, or when the handset is replaced in its cradle. This is a common event associated with the closing of any electrical circuit. The user should not plug the phone into a power outlet, and should not put a charged handset into the cradle, if the phone is located in an environment containing concentrations of flammable or flame-supporting gases, unless there is adequate ventilation. A spark in such an environment could create a fire or explosion. Such environments might include: medical use of oxygen without adequate ventilation; industrial gases (cleaning solvents; gasoline vapors; etc.); a leak of natural gas; etc.
- **Do not use this product near water, or when you are wet.** For example, do not use it in a wet basement or shower, or next to a swimming pool, bathtub, kitchen sink, or laundry tub. Do not use liquids or aerosol sprays for cleaning. If the product comes in contact with any liquids, unplug any line or power cord immediately. Do not plug the product back in until it has dried thoroughly.
- **Install this product in a protected location** where no one can trip over any line or power cords. Protect cords from damage or abrasion.
- **If this product does not operate normally, read the Troubleshooting section in this user's manual on pages 44-47.** If you cannot solve the problem, or if the product is damaged, refer to the **Limited warranty** section on pages 53-54. Do not open this product except as may be directed in your user's manual. Opening the product or reassembling it incorrectly may expose you to hazardous voltages or other risks.
- **If this product has user-replaceable batteries, replace batteries only as described in the your user's manual.** Do not burn or puncture batteries—they contain caustic chemicals.
- **If this product has a three-prong (grounding) plug or a polarized plug with one wide prong, it might not fit in outlets that are not polarized.** Do not defeat the purpose of these plugs. If they do not fit in your outlet, the outlet should be replaced by an electrician.



CAUTION: Use only the power adapter provided with this product. To obtain a replacement, visit our website at **www.telephones.att.com**, or call **1 (800) 222-3111**. In Canada, dial **1 (866) 288-4268**.

Especially about corded telephones

- **Electrical power:** The telephone base must be connected to a working electrical outlet. The electrical outlet should not be controlled by a wall switch. **Calls cannot be made from the handset if the telephone base is unplugged, switched off, or if the electrical power is interrupted.**
- **Power adapter:** The power adapter is intended to be correctly oriented in a vertical or floor mount position. The prongs are not designed to hold the plug in place if it is plugged into a ceiling, under-the-table or cabinet outlet.

SAVE THESE INSTRUCTIONS

FCC and ACTA information

If this equipment was approved for connection to the telephone network prior to July 23, 2001, it complies with Part 68 of the Federal Communications Commission (FCC) rules. If the equipment was approved after that date, it complies with the Part 68 rules and with the Technical Requirements for Connection of Equipment to the Telephone Network adopted by the Administrative Council for Terminal Attachments (ACTA). We are required to provide you with the following information.

1. Product identifier and REN information

The label on the back or bottom of this equipment contains, among other things, an identifier indicating product approval and the Ringer Equivalence Number (REN). This information must be provided to your telephone service provider upon request. For equipment approved prior to July 23, 2001, the product identifier is preceded by the phrase "FCC Reg No." and the REN is listed separately. For equipment approved after that date, the product identifier is preceded by "US" and a colon (:), and the REN is encoded in the product identifier without a decimal point as the sixth and seventh characters following the colon. For example, the product identifier US:AAAEQ03T123XYZ indicates the REN would be 0.3.

The REN is used to determine how many devices you can connect to your telephone line and still have them ring when you are called. In most, but not all areas, the sum of all RENS should be five (5.0) or less. You might want to contact your telephone service provider for more information.

2. Connection and use with the nationwide telephone network

The plug and jack used to connect this equipment to the premises wiring and the telephone network must comply with the applicable Part 68 rules and technical requirements adopted by ACTA. A compliant telephone cord and modular plug is provided with this product. It is designed to be connected to a compatible modular wall jack that is also compliant. An RJ11 jack should normally be used for connecting to a single line and an RJ14 jack for two lines, see installation instructions in the user's manual. This equipment may not be used with coin telephone lines or with party lines. If you have specially wired alarm dialing equipment connected to your telephone line, ensure the connection of this equipment does not disable your alarm equipment. If you have questions about what will disable the alarm equipment, consult your telephone service provider or qualified installer.

3. Repair instructions

If this equipment is malfunctioning, it must be unplugged from the modular wall jack until the problem has been corrected. Repairs to this telephone equipment can only be made by the manufacturer or its authorized agents. For repair procedures, follow the instructions outlined under the limited warranty.

4. Rights of the telephone service provider

If this equipment is causing harm to the telephone network, the telephone service provider may temporarily discontinue your telephone service. The telephone service provider is required to notify you before interrupting service. If advance notice is not practical, you will be notified as soon as possible. You will be given the opportunity to correct the problem and the telephone service provider is required to inform you of your right to file a complaint with the FCC. Your telephone service provider may make changes in its facilities, equipment, operation, or procedures that could affect the proper functioning of this product. The telephone service provider is required to notify you if such changes are planned.

5. Hearing aid compatibility

If this product is equipped with a corded or cordless handset, it is hearing aid compatible.

FCC and ACTA information

6. Programming/testing of emergency numbers

If this product has memory dialing locations, you may choose to store police, fire department and emergency medical service telephone numbers in these locations. If you do, please keep three things in mind:

- a. We recommend that you also write the telephone number on the directory card (if applicable), so that you can still dial the emergency number manually if the memory dialing feature doesn't work.
- b. This feature is provided only as a convenience, and the manufacturer assumes no responsibility for customer reliance upon the memory feature.
- c. Testing the emergency telephone numbers you have stored is not recommended. However, if you do make a call to an emergency number:
 - You must remain on the line and briefly explain the reason for the call before hanging up.
 - Programming/testing of emergency numbers should be performed during off-peak hours, such as in the early morning or late evening, when the emergency services tend to be less busy.

Part 15 of FCC rules

Some telephone equipment generates, uses, and can radiate radio-frequency energy and, if not installed and used properly, may cause interference to radio and television reception. This product has been tested and found to meet the standards for a class B digital device, as specified in Part 15 of the FCC rules.

These specifications are designed to provide reasonable protection against such interference in a residential installation. However, there is no guarantee that interference will not occur in a particular installation.

If this product causes interference to radio, VCR or television reception when it is in use, you might correct the interference with any one or all of these measures:

- Where it can be done safely, reorient the receiving radio, VCR or television antenna.
- To the extent possible, relocate the radio, VCR, television or other receiver with respect to the telephone equipment.
- If this telephone product runs on AC power, plug your product into an AC outlet that's not on the same circuit as one used by your radio, VCR or television.
- Consult a dealer or an experienced radio/TV technician for help.

Modifications to this product, not expressly approved by the manufacturer, could void the user's authority to operate the equipment.

This Class B digital apparatus complies with Canadian ICES-003.

Industry Canada

Operation is subject to the following two conditions: (1) this device may not cause harmful interference, and (2) this device must accept any interference, including interference that may cause undesired operation.

The term "IC:" before the certification/registration number only signifies that the Industry Canada technical specifications were met.

The Ringer Equivalence Number (REN) for this terminal equipment is 0.7. The REN is an indication of the maximum number of devices allowed to be connected to a telephone interface.

The termination on an interface may consist of any combination of devices subject only to the requirement that the sum of the RENs of all the devices does not exceed five.

This product meets the applicable Industry Canada technical specifications.

Limited warranty

The AT&T brand is used under license - any repair, replacement or warranty service, and all questions about this product should be directed to: In the United States of America, call

1 (800) 222-3111 or visit **www.telephones.att.com**. In Canada, dial **1 (866) 288-4268**.

1. What does this limited warranty cover?

The manufacturer of this AT&T branded product warrants to the holder of a valid proof of purchase ("CONSUMER" or "you") that the product and all accessories provided in the sales package ("PRODUCT") are free from defects in material and workmanship, pursuant to the following terms and conditions, when installed and used normally and in accordance with the PRODUCT operating instructions. This limited warranty extends only to the CONSUMER for products purchased and used in the United States of America and Canada.

2. What will be done if the PRODUCT is not free from defects in materials and workmanship during the limited warranty period ("materially defective PRODUCT")?

During the limited warranty period, the manufacturer's authorized service representative repairs or replaces at the manufacturer's option, without charge, a materially defective PRODUCT. If the manufacturer repairs the PRODUCT, they may use new or refurbished replacement parts. If the manufacturer chooses to replace the PRODUCT, they may replace it with a new or refurbished PRODUCT of the same or similar design. The manufacturer will retain the defective parts, modules, or equipment. Repair or replacement of the PRODUCT, at the manufacturer's option, is your exclusive remedy. The manufacturer returns the repaired or replacement products to you in working condition. You should expect the repair or replacement to take approximately 30 days.

3. How long is the limited warranty period?

The limited warranty period for the PRODUCT extends for ONE (1) YEAR from the date of purchase. If the manufacturer repairs or replaces a materially defective PRODUCT under the terms of this limited warranty, this limited warranty also applies to repaired or replacement PRODUCT for a period of either (a) 90 days from the date the repaired or replacement PRODUCT is shipped to you or (b) the time remaining on the original one-year limited warranty; whichever is longer.

4. What is not covered by this limited warranty?

This limited warranty does not cover:

- PRODUCT that has been subjected to misuse, accident, shipping or other physical damage, improper installation, abnormal operation or handling, neglect, inundation, fire, water, or other liquid intrusion; or
- PRODUCT that has been damaged due to repair, alteration, or modification by anyone other than an authorized service representative of the manufacturer; or
- PRODUCT to the extent that the problem experienced is caused by signal conditions, network reliability or cable or antenna systems; or
- PRODUCT to the extent that the problem is caused by use with non-AT&T accessories; or
- PRODUCT whose warranty/quality stickers, PRODUCT serial number plates or electronic serial numbers have been removed, altered or rendered illegible; or
- PRODUCT purchased, used, serviced, or shipped for repair from outside the United States of America or Canada, or used for commercial or institutional purposes (including but not limited to products used for rental purposes); or
- PRODUCT returned without a valid proof of purchase (see item 6 below); or
- Charges for installation or setup, adjustment of customer controls, and installation or repair of systems outside the unit.

Limited warranty

5. How do you get warranty service?

To obtain warranty service in the United States of America, visit

www.telephones.att.com or call **1 (800) 222-3111**; in Canada, please

dial **1 (866) 288-4268**. NOTE: Before calling for service, please review the user's manual. A check of the PRODUCT's controls and features might save you a service call.

Except as provided by applicable law, you assume the risk of loss or damage during transit and transportation and are responsible for delivery or handling charges incurred in the transport of the PRODUCT(s) to the service location. The manufacturer will return repaired or replaced PRODUCT under this limited warranty. Transportation, delivery or handling charges are prepaid. The manufacturer assumes no risk for damage or loss of the PRODUCT in transit. If the PRODUCT failure is not covered by this limited warranty, or proof of purchase does not meet the terms of this limited warranty, the manufacturer notifies you and requests that you authorize the cost of repair prior to any further repair activity. You must pay for the cost of repair and return shipping costs for the repair of products that are not covered by this limited warranty.

6. What must you return with the PRODUCT to get warranty service?

You must:

- Return the entire original package and contents including the PRODUCT to the service location along with a description of the malfunction or difficulty; and
- Include a "valid proof of purchase" (sales receipt) identifying the PRODUCT purchased (PRODUCT model) and the date of purchase or receipt; and
- Provide your name, complete and correct mailing address, and telephone number.

7. Other limitations

This warranty is the complete and exclusive agreement between you and the manufacturer of this AT&T branded PRODUCT. It supersedes all other written or oral communications related to this PRODUCT. The manufacturer provides no other warranties for this PRODUCT. The warranty exclusively describes all of the manufacturer's responsibilities regarding the PRODUCT. There are no other express warranties. No one is authorized to make modifications to this limited warranty and you should not rely on any such modification.

State/Provincial Law Rights: This warranty gives you specific legal rights, and you might also have other rights that vary from state to state or province to province.

Limitations: Implied warranties, including those of fitness for a particular purpose and merchantability (an unwritten warranty that the PRODUCT is fit for ordinary use) are limited to one year from date of purchase. Some states/provinces do not allow limitations on how long an implied warranty lasts, so the above limitation might not apply to you. In no event shall the manufacturer be liable for any indirect, special, incidental, consequential, or similar damages (including, but not limited to lost profits or revenue, inability to use the PRODUCT or other associated equipment, the cost of substitute equipment, and claims by third parties) resulting from the use of this PRODUCT. Some states/provinces do not allow the exclusion or limitation of incidental or consequential damages, so the above limitation or exclusion might not apply to you.

Please retain your original sales receipt as proof of purchase.

Technical specifications

Operating temperature	32°F — 122°F 0°C — 50°C
-----------------------	----------------------------

Power adapter	input: 117V AC 60Hz output: 9V AC 300mA
---------------	--

Index

A

- AC adapter, 5, 6
- Alert tones, 42
- Answer a call, 20

B

- Backlight, 15

C

- Caller ID
 - Delete entries, 38
 - Dial an entry, 38
 - Dialing options, 38
 - Reviewing call history, 37
 - Save entries to speed dial, 40
 - Save entries to the directory, 39
- Caller ID history (call log), 36
- Caller ID screen messages, 41
- Call waiting, 23, 35
- Chain dialing, 25
- Character chart, 31
- Clearspeak, 21
- Clear voicemail indication, 18
- Clock, 14
- Conference calls, 24
- COVM (central office voicemail), 19

D

- Data port, 7
- Date and time, 14
- Directory
 - Capacity, 31
 - Create entries, 32
 - Delete entries, 34
 - Dial entries, 34
 - Editing entries, 34
 - Review entries, 33

- Search entries, 33

- Directory card, 12
- Display dial, 34
- DSL, 5, 6

E

- Elapsed time, 20
- End a call, 20

F

- Flash, 23

G

- General product care, 48

H

- Headset (optional), 12
- Hold, 23
- Home area code, 17

I

- Important safety information, 49
- Indicator lights, 42
- Installation, 4–11

L

- Language, 16
- Last number redial, 22
- LCD backlight, 15
- Limited warranty, 53–54
- Line power mode, 26
- Local area code, 17

M

- Make a call, 20
- Memory match, 37
- Missed calls indicator, 37
- Mute, 23

Index

O

On hook dialing, 21

P

Predialing, 21

Preferred mode, 15

Primary line, 14

R

Redial

- Delete a redial entry, 22

- Dial a redial entry, 22

Ringer volume, 16

S

Safety information, 49

Screen display messages, 43

Searching by name, 33

Speakerphone, 20

Speed dial

- Delete a number, 30

- Dial a number, 30

- Edit a number, 29

- Review a number, 28

- Store a number, 28

Speed dial memory, 27

Switch between the handset, headset
and speakerphone, 21

Switching between lines, 24

T

Tabletop installation, 10–11

Technical specifications, 55

Telephone base installation, 4–6

Three-way conference call, 24

Time, 14

Troubleshooting, 44–47

V

Voicemail indicator, 18

Volume, 16, 23

W

Wall installation, 8–10

Warranty, 53–54



www.telephones.att.com

Clearspeak™ is a trademark of Advanced American Telephones.

© 2011 Advanced American Telephones. All Rights Reserved.

AT&T and the AT&T logo are trademarks of AT&T Intellectual Property licensed to
Advanced American Telephones, San Antonio, TX 78219.

Printed in China. Issue 2 AT&T 11/11.