



at&t



SynJ™

Proud Sponsor

User's manual

SynJ SB67148

**DECT 6.0 4-line expansion deskset
for use with AT&T model
SynJ SB67118/SB67138**



Congratulations

on your purchase of this AT&T product. Before using this AT&T product, please read the **Important safety information** on pages 76-77 of this manual. Please thoroughly read this user's manual for all the feature operations and troubleshooting information necessary to install and operate your new AT&T product. You can also visit our website at **www.telephones.att.com** or call **1 (888) 915-2007**. In Canada, dial **1 (866) 288-4268**.

Model number: SynJ™ SB67148

Type: DECT 6.0 expansion deskset

Serial number: _____

Purchase date: _____

Place of purchase: _____

Both the model and serial numbers of your AT&T product can be found on the bottom of the deskset.

Save your sales receipt and original packaging in case it is necessary to return this product for warranty service.



Telephones identified with this logo have reduced noise and interference when used with most T-coil equipped hearing aids and cochlear implants. The TIA-1083 Compliant Logo is a trademark of the Telecommunications Industry Association. Used under license.

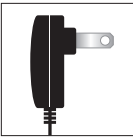

Powered by an ENERGY STAR® qualified adapter for a better environment

The ENERGY STAR® program (www.energystar.gov) recognizes and encourages the use of products that save energy and help protect our environment. We are proud to supply this product with an ENERGY STAR® qualified power adapter meeting the latest energy efficiency guidelines.

Parts checklist

Check to make sure the telephone package includes the following items:

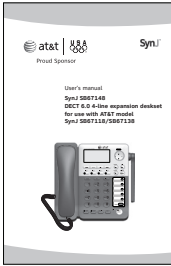

User's manual

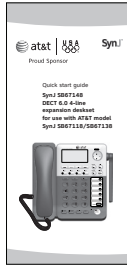

Quick start guide



Deskset



Handset with coiled cord installed



Backup battery



Deskset power adapter

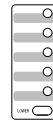

Additional directory card

SynJ SB67148

DECT 6.0 4-line expansion deskset

for use with AT&T model

SynJ SB67118/SB67138



Table of contents

Getting started

Quick reference guide	1
Installation	4
Deskset installation	5
Backup battery installation	6
Backup battery charging	7
Add and register a deskset	8
Register the deskset to your SynJ SB67118 telephone base	8
Register the deskset to your SynJ SB67138 telephone base	9
Deregister a deskset	10
Deregister the deskset to your SynJ SB67118 telephone base	10
Deregister the deskset to your SynJ SB67138 telephone base	11
Add a corded headset	12
Add a corded headset to the deskset	12

Deskset settings

Deskset setup	13
Menu settings	13
Ringer volume	13
Ringer tone	14
LCD contrast	15
Key tone	15
Language	16
Line selection	16
Deskset name	17
Hold reminder	17
Speed dial setup	18
Customer support	18

Deskset operation

Deskset basic operation	19
Line indicators	19
Make a call	19
On hook dialing (predialing)	20
Dial a speed dial number	21
Answer a call	21
End a call	21
Switch among the corded handset, the speakerphone and the corded headset	22
Temporary ringer silencing	22
Last number redial	22
Options while on calls	24
Volume control	24
Call waiting	24
Mute	24
Call privacy	25
Record a call	26
Hold	27
Switch among lines	27
Join a call in progress	27
Chain dialing	28
Three-way conference calls	28
COVM (central office voicemail)	30
Intercom	31
Make an intercom call	31
Answer an incoming call during an intercom call	32
Answer an intercom call	32
End an intercom call	32
Call transfer using intercom	33
Push to talk (PTT) intercom	35

PTT to the main telephone base or a system device	35
PTT to all devices	36
Answer a PTT call	37
Convert a PTT call to an intercom call	37
End a PTT call	37

Directory

About the directory	38
Capacity	38
Exit the directory	38
Create directory entries	39
Create a new directory entry	39
Store a pause in a directory entry	40
Store a flash in a directory entry	40
Review directory	41
Review directory entries	41
Search directory	42
Search by name	42
Dial, delete or edit directory entries	43
Display dial	43
Delete an entry	43
Delete all entries	43
Edit an entry	43

Caller ID

About caller ID	44
Information about caller ID with call waiting	44
Caller ID Information	45
How the caller ID information (call log) works	45
Caller ID operation	46
Memory match	46
Missed (new) calls indicator	46
Review the caller ID information	46
View dialing options	47
Dial a call log entry	47
Delete the call log entries	47
Save a call log entry to the directory	48
Reasons for missing caller ID information	49

Answering system

Deskset voicemail box (answer system)	50
Answering system and voicemail	50
Set the answering system to answer automatically	51
Answering system capacity	51
Voice prompts	51
Deskset mailbox setup	52
Deskset mailbox overview	52
New message indication	52
Fast answer mode	52
Set access code (remote access code) and mailbox security	53
Notify alert	54
Deskset announcement setup	56
Message playback	57
Options during playback	58
Transfer messages	58
Call back to the mailbox message caller	59
Delete all old messages	59
Record and deliver memos	60
Remote access	61

Appendix

Screen icons, indicator tones and lights	63
Screen icons	63
Indicator tones	63
Indicator lights	64
Deskset display screen messages	65
Troubleshooting	67
Maintenance	75
Important safety information	76
FCC part 68 and ACTA	78
FCC part 15	79
Limited warranty	80
Technical specifications	82
Backup battery	82
DECT 6.0 digital technology	82
Telephone operating range	82

Index

Index	83
-------------	----

Getting started
Quick reference guide

HOLD

Press to place an outside call on hold (page 27).

LINE 1-LINE 4 keys

Press to make or answer a call on the desired line (pages 19-21).

EXIT

While in a menu, press to cancel an operation and exit the menu display.

NEW CALL indicator

On when there are new or missed calls (page 46).

▲DIR

Press to view directory information (page 41).

▼CID

Press to view caller ID information (page 46).

▶▶/SKIP

During message playback, press to skip to the next message (page 58).

QO/MAILBOX

When in idle mode, press to enter the general or an assigned mailbox menu (page 57).

◀◀/REPEAT

During message playback, press to repeat a message, or press twice to play the previous message (page 58).

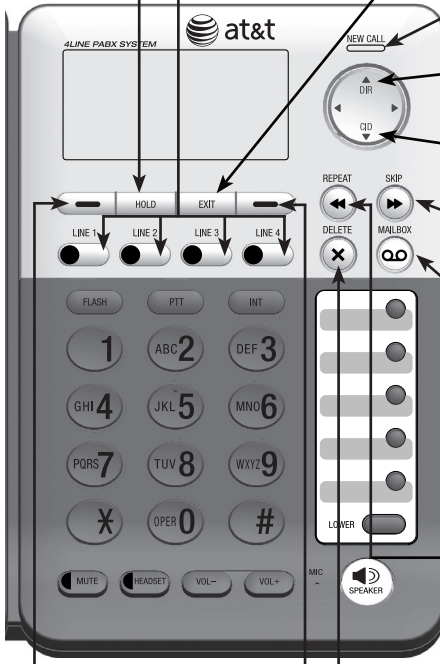

Softkeys (2)

Press to select a menu item displayed above the key.

X/DELETE

Press to delete the message currently playing (page 58).
Press to delete an entry while reviewing the redial list (page 23), directory (page 43) or call log (page 47).
Press to delete a digit or character while entering numbers or names.

Navigation keys

While in menus, press ▲DIR or ▼CID to scroll through the menus, highlight items or to change settings.

While entering names or numbers, press ◀ or ▶ to move the cursor to the left or right.

While playing back messages, press ◀ once to repeat the message, or press ◀ twice to hear the previous message, or press ▶ to skip to the next message.

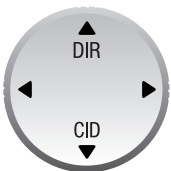

Getting started

Quick reference guide

FLASH

During a call, press to answer an incoming call when you receive a call waiting alert (page 24).

PTT

Press to initiate a PTT call (page 35).
Press and hold to broadcast to all extensions (page 36).

INT

When in idle mode, press to initiate an intercom call (page 31).

Speed dial keys

Press to review or dial a stored speed dial number when the deskset is not in use (page 21).

LOWER

Press to enter the lower speed dial locations (page 21).

🔊 SPEAKER

Press to turn on the speakerphone. Press again to turn it off (page 22).

MUTE

During a call, press to mute the microphone (page 24).

During an incoming call, press to mute the ringer (page 22).

HEADSET

When a corded headset is connected to the deskset, press to get a line, answer a call or hang up (pages 19-22). The red indicator is on when the headset is in use.

VOL+/VOL-

During a call, press to adjust the listening volume (page 24).

During message playback, press to adjust the playback volume (page 58).

Press to adjust the ringer volume (page 13).

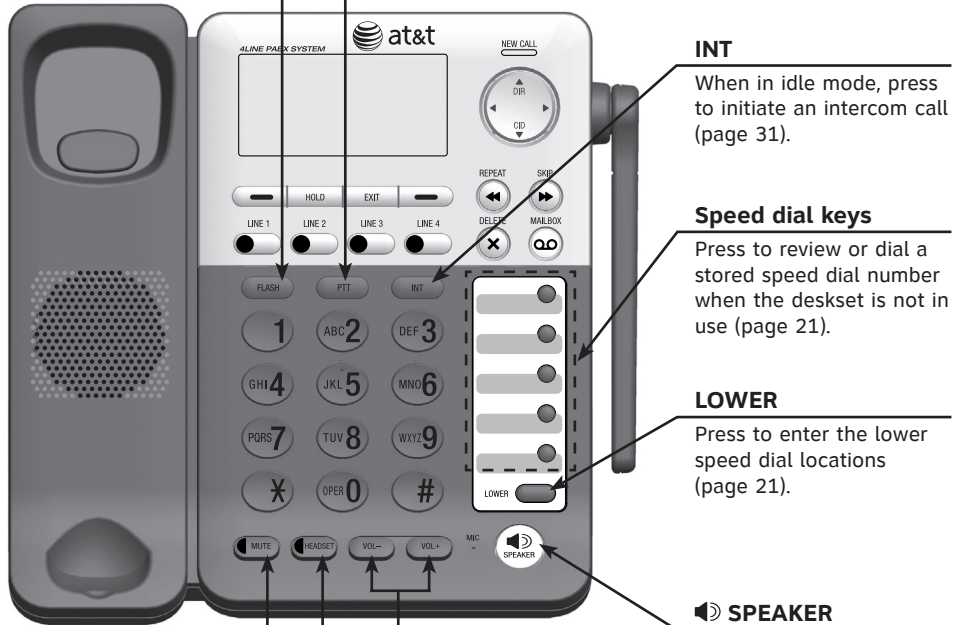

Directory card

To write names on the directory card:

1. Remove the clear plastic cover by inserting the tip of a small item such as a paperclip into the hole at the top edge of the cover.
2. Pull out the directory card.
3. Write the information on the directory card.
4. Replace the directory card and the plastic cover.



Main menu

The > symbol highlights a menu item.

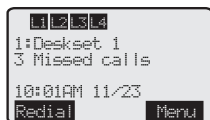

Main menu

- Directory (pages 38-43)
- Call log (pages 44-48)
- Ringer setting (pages 13-14)
- Mailbox setup (pages 52-56)
- Deskset setup (pages 15-17)
- COVM (page 30)
- Speed dial setup (page 18)
- Customer support (page 18)



Using menus:

1. Press the **Menu** softkey to show the first menu item, **Directory**.
2. Press **▲DIR** or **▼CID** to scroll through menu items.
3. Press the **Select** softkey to select or the **Save** softkey to save changes to a highlighted menu item.
4. Press the **Back** softkey to cancel an operation or back up to the previous menu.

Installation

Install the deskset close to a power outlet not controlled by a wall switch. The deskset should be placed on a flat surface. For optimum range and better reception, place the deskset near the main telephone base.

Your product may be shipped with a protective sticker covering the deskset display - remove it before use.

For customer service or product information, visit our website at **www.telephones.att.com** or call **1 (888) 915-2007**. In Canada, dial **1 (866) 288-4268**.

Avoid placing the deskset too close to:

- Communication devices such as television sets, VCRs, or other cordless telephones.
- Excessive heat sources.
- Noise sources such as a window with traffic outside, motors, microwave ovens, refrigerators, or fluorescent lighting.
- Excessive dust sources such as a workshop or garage.
- Excessive moisture.
- Extremely low temperature.
- Mechanical vibration or shock such as on top of a washing machine or work bench.

Getting started
Deskset installation

Install the deskset as shown below.

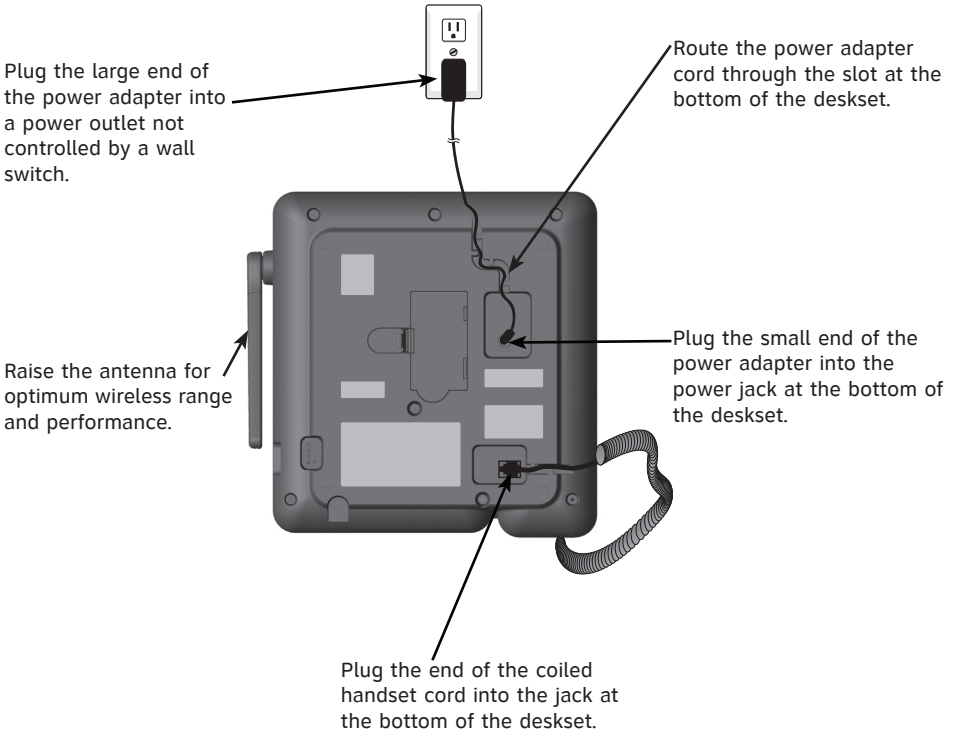

IMPORTANT INFORMATION:

- Use only the power adapter supplied with this product. To order a replacement power adapter, visit our website at **www.telephones.att.com**, or call **1 (888) 915-2007**. In Canada, dial **1 (866) 288-4268**.
- The power adapter is intended to be correctly oriented in a vertical or floor mount position. The prongs are not designed to hold the plug in place if it is plugged into a ceiling, under-the-table or cabinet outlet.

Backup battery installation

Install the backup battery as shown below. In the event of a power failure, the charged backup battery allows the deskset to operate. Plug in the AC power adapter into the power jack at the bottom of the deskset to charge the backup battery.

1. Press down the tab to open the battery compartment cover.

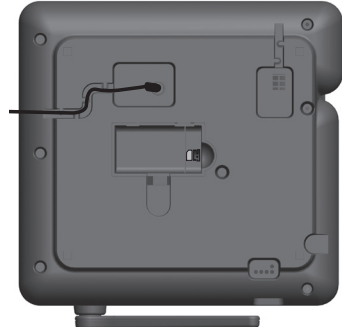
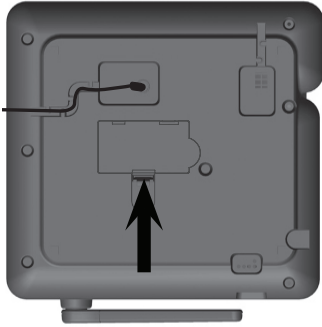

2. Place the battery in the compartment. Make sure the supplied battery with the label **THIS SIDE UP** faces up as indicated.

3. Align the cover flat against the battery compartment, then press down until it clicks into place.

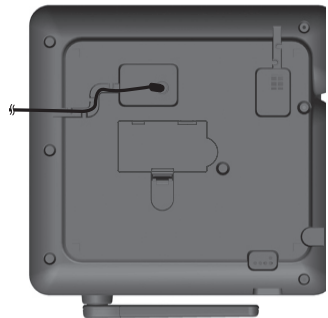



IMPORTANT INFORMATION:

Use only the supplied rechargeable battery or replacement battery (model 27910). To order, visit our website at www.telephones.att.com, or call **1 (888) 915-2007**. In Canada, dial **1 (866) 288-4268**.

Backup battery charging

When the deskset loses power with the backup battery installed, the screen indicates the battery status (see table below) and displays **Check AC power**. When the backup battery is in low battery mode, the screen displays **Low battery**. The backup battery is fully charged after 16 hours of continuous charging. See the table on page 82 for battery operating times.

The following table summarizes the battery charge indicators and actions to take.

Battery indicators	Battery status	Action
The screen shows Low battery and  flashes.	Battery has enough charge to be used for a short time.	Charge without interruption at least one hour.
The screen shows  .	Battery is fully charged.	Keep the backup battery in the battery compartment to recharge.

Add and register a deskset

The handset provided with the SynJ SB67118/SB67138 is already registered as **Handset 1**. Additional desksets are assigned numbers in the order they are registered (**Deskset 2** to **Deskset 10**). You can register a maximum of 10 desksets/handsets, or 9 desksets/handsets and one cordless headset.

You can add desksets (SynJ SB67148, purchased separately) to the SynJ SB67118/SB67138 at any time, but each new deskset must be registered with the main telephone base before use.

Start registration when the deskset shows **Press MENU on Main base, select Registration & then Register HS. Then press Start.**



Register the deskset to your SynJ SB67118 telephone base

1. On the SynJ SB67118 telephone base, press **MENU/ENTER**.
2. Scroll down to **Registration** and then press **MENU/ENTER**.
3. Press **MENU/ENTER** again to select **Register HS**. The main telephone base displays **Handset registering**.
4. Press the **Start** softkey on the unregistered deskset. The deskset shows **Register...Please wait**. You hear a beep when the registration process is successful. The main telephone base shows **Handset registered**. The deskset shows **Registered** and then **X:Deskset X** (X represents the extension number [1-0]; **Deskset X** represents the default deskset name). It takes up to 60 seconds to complete the registration process.

SB67118:

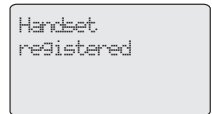
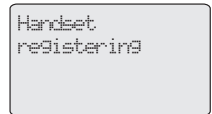
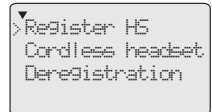
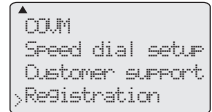

SB67148:

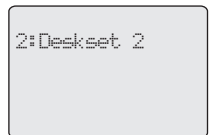

Add and register a deskset

Register the deskset to your SynJ SB67138 telephone base

1. On the SynJ SB67138 telephone base, press **MENU/ENTER**.
2. Scroll down to **Registration** and press **MENU/ENTER**.
3. Press **MENU/ENTER** again to select **Register HS**.
The main telephone base screen shows **Registering new device...**
4. Press the **Start** softkey on the unregistered deskset. The deskset shows **Registering...Please wait**. You hear a beep sound when the registration process is successful. The main telephone base shows **Deskset registered**. The deskset shows **Registered** and then **X:Deskset X** (**X** represents the extension number [**1-0**]; **Deskset X** represents the default deskset name). It takes up to 60 seconds to complete the registration process.



NOTE: If the registration fails, the screen shows **Press MENU on MAIN base, select Registration & then Register HS. Then press Start**. Try the registration process again.

SB67138:

```
▲
COUM
Speed dial setup
Customer support
>Registration
```

```
▼
>Register HS
Deregistration
```

```
Registering
new device...
```

```
Deskset
registered
```

SB67148:

```
2*Deskset 2
```

Deregister a deskset

You may need to deregister the deskset from the main telephone base if you already have ten registered devices and need to replace a deskset, or if you wish to change the assigned number of your registered devices.

You must first deregister ALL the registered devices, and then register each device that you wish to use again individually.

Please read carefully through all the instructions in this section before beginning the deregistration process.

Please make sure the telephone system is not in use before deregistration. Deregistering a deskset does not remove the data saved on it. For details, see **Deregister handsets and headset** in the SynJ SB67118/SB67138 user's manual.

Deregister the deskset to your SynJ SB67118 telephone base

1. On the SynJ SB67118 telephone base, press **MENU/ENTER**.
2. Scroll down to **Registration** and press **MENU/ENTER**.
3. Scroll down to **Deregistration** and press **MENU/ENTER**.
4. The main telephone base shows **Deregister all devices? <=No >=Yes**. Press **◀REP** to exit or press **SKIP▶** to continue the deregistration process.
5. The main telephone base shows **Deregistering**. The main telephone base shows **All handsets deregistered** and beeps when the deregistration process is successful. It takes up to 10 seconds to complete.

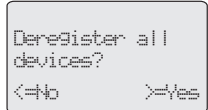

```
Deregister all
devices?
<=No      >=Yes
```

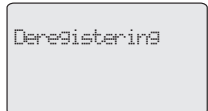

```
Deregistering
```



```
All handsets
deregistered
```

Deregister a deskset

Deregister the deskset to your SynJ SB67138 telephone base

1. On the SynJ SB67138 telephone base, press **MENU/ENTER**.
2. Scroll down to **Registration** and press **MENU/ENTER**.
3. Scroll down to **Deregistration** and press **MENU/ENTER**.
4. The main telephone base shows
Deregister all devices? <=No >=Yes. Press **◀REP** to exit or press **SKIP▶** to continue the deregistration process.
5. The main telephone base shows **Deregistering**. The main telephone base shows **All devices deregistered** and beeps when the deregistration process is successful. It takes up to 10 seconds to complete.

```
Deregister all
devices?
<=No      >=Yes
```

```
Deregistering
```

```
All devices
deregistered
```



NOTES:

- If the deregistration process fails, you may need to reset the system and try again. To reset, you can press **EXIT** on the main telephone base. You can also reset the main telephone base by unplugging the power from it and plugging it back in.
- To register a deskset again, refer to the registration information on pages 8 and 9.

Getting started

Add a corded headset

You can use this deskset handsfree when you install any industry-standard 2.5mm corded telephone headset (purchased separately). For best results, use a 2.5mm corded headset. To purchase a headset, visit our website at www.telephones.att.com, or call **1 (888) 915-2007**. In Canada, dial **1 (866) 288-4268**. See pages 19-22 for instructions on using the corded headset with this deskset.

Add a corded headset to the deskset

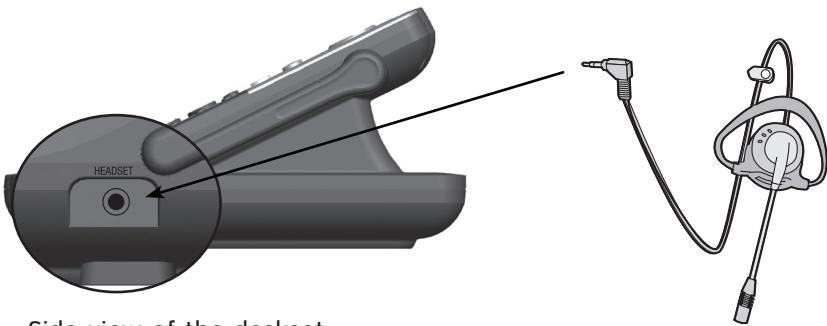

Side view of the deskset

Plug a 2.5 mm headset into the **HEADSET** jack on the side of the deskset.

Menu settings

Use the menus to change the deskset settings.

1. Press the **Menu** softkey to enter the main menu when the deskset is not in use.
2. Press **▲DIR** or **▼CID** to scroll to the feature to be changed. The > symbol indicates the selected menu item.
3. Press the **Select** softkey to select the menu item.
4. Press the **Back** softkey to cancel an operation, exit the menu display, or return to the previous menu.



-OR-

Press **◀** to return to the previous menu.

-OR-

Press **EXIT** to exit to idle mode without making any changes.

Ringer volume

Use this feature to set the ringer volume to one of three levels or turn the ringer off. When the ringer is off,  icon appears on the deskset.

1. When the deskset is not in use, press the **Menu** softkey.
2. Press **▲DIR** or **▼CID** to scroll to **Ringer setting**.
3. Press the **Select** softkey twice to select **Ringer volume**.
4. Press **▲DIR**, **▶** or **VOL+** to increase the ringer volume. Press **▼CID**, **◀** or **VOL-** to decrease the ringer volume.
5. Press the **Set** softkey to save the setting and return to the previous menu. There is a confirmation tone.



NOTE: The ringer volume also determines the ringer volume for intercom calls. If the ringer volume is set to off, the deskset is silenced for all incoming calls, including intercom calls.



Deskset setup

Ringer tone

Use this feature to turn the key tone on and off. The telephone base is factory set to beep with each key press. You can turn off this beep sound by turning the key tone off.

1. When the deskset is not in use, press the **Menu** softkey.
2. Press **▲DIR** or **▼CID** to scroll to **Ringer setting**. Press the **Select** softkey.
3. Press **▲DIR** or **▼CID** to scroll to **Ringer tone**. Press the **Select** softkey.
4. Press **◀** or **▶** to select a desired line (**L1**, **L2**, **L3** or **L4**).
5. Press **▲DIR** or **▼CID** to select a desired ringer tone.
6. Repeat Step 4 and Step 5 above to choose ringer tones for other lines if desired.
7. Press the **Save** softkey to save the setting and return to the previous menu. There is a confirmation tone.



NOTE: If you turn off the ringer volume, you will not hear ringer tone samples.

LCD contrast

Use this feature to adjust the screen contrast to one of five levels to optimize readability in different lighting conditions.

1. When the deskset is not in use, press the **Menu** softkey.
2. Press **▲DIR** or **▼CID** to scroll to **Deskset setup**. Press the **Select** softkey.
3. Press the **Select** softkey to select **LCD contrast**.
4. Press **▲DIR** or **▼CID** to adjust the screen contrast level. The screen display temporarily fades away as you press **▼CID** and reappears as you press **▲DIR**.
5. Press the **Save** softkey to save the setting and return to the previous menu. There is a confirmation tone.

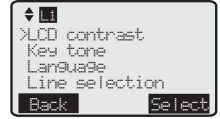

Key tone

Use this feature to turn the key tone on or off. The deskset is factory programmed to beep with each key press. If you turn off the key tone, there are no beeps when you press the keys.

1. When the deskset is not in use, press the **Menu** softkey.
2. Press **▲DIR** or **▼CID** to scroll to **Deskset setup**. Press the **Select** softkey.
3. Press **▲DIR** or **▼CID** to scroll to **Key tone**. Press the **Select** softkey.
4. Press **▲DIR** or **▼CID** to scroll to **On** or **Off**.
5. Press the **Save** softkey to save the setting and return to the previous menu. There is a confirmation tone.



Deskset setup

Language

Use this feature to change the display language that is used in all menus and screen displays. This telephone comes factory set for English displays.

1. When the deskset is not in use, press the **Menu** softkey.
2. Press **▲DIR** or **▼CID** to scroll to **Deskset setup**. Press the **Select** softkey.
3. Press **▲DIR** or **▼CID** to scroll to **Language**. Press the **Select** softkey.
4. Press **▲DIR** or **▼CID** to select **English** or **Español**.
5. Press the **Save** softkey to save the setting and return to the previous menu. There is a confirmation tone.

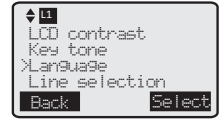

Line selection

Use this feature to select the default telephone line to be used when you make outgoing calls. The deskset comes factory set for **Auto** selectable line, which chooses the first available line for making a call. To select a particular line, choose **Line 1**, **Line 2**, **Line 3** or **Line 4**.

1. When the deskset is not in use, press the **Menu** softkey.
2. Press **▲DIR** or **▼CID** to scroll to **Deskset setup**. Press the **Select** softkey.
3. Press **▲DIR** or **▼CID** to scroll to **Line selection**. Press the **Select** softkey.
4. Press **▲DIR** or **▼CID** to select **Auto**, **Line 1**, **Line 2**, **Line 3** or **Line 4**.
5. Press the **Save** softkey to save the setting and return to the previous menu. There is a confirmation tone.

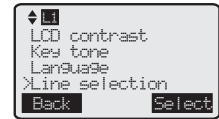

Deskset name

Use this feature to change the deskset name.

1. When the deskset is not in use, press the **Menu** softkey.
2. Press **▲DIR** or **▼CID** to scroll to **Deskset setup**. Press the **Select** softkey.
3. Press **▲DIR** or **▼CID** to scroll to **Deskset name**. Press the **Select** softkey.
4. Use the dialing keys (page 40) to enter a name.
 - Press **◀** move the cursor to the left or **▶** to the right.
 - Press **X/DELETE** to erase a character.
 - Press and hold X/DELETE to erase all characters.
5. Press the **Save** softkey to confirm and return to the previous menu. There is a confirmation tone.

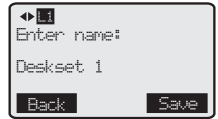
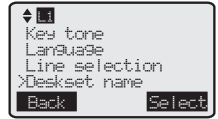

Hold reminder

When there is a call on hold for more than three minutes, the deskset gives you a reminder beep once every 30 seconds. You can also turn this setting off.

1. When the deskset is not in use, press the **Menu** softkey.
2. Press **▲DIR** or **▼CID** to scroll to **Deskset setup**. Press the **Select** softkey.
3. Press **▲DIR** or **▼CID** to scroll to **Hold Reminder**. Press the **Select** softkey.
4. Press **▲DIR** or **▼CID** to scroll to **On** or **Off**.
5. Press the **Save** softkey to save the setting and return to the previous menu. There is a confirmation tone.



NOTE: A call on hold after 10 minutes is automatically forwarded to the auto attendant, even if the auto attendant is not activated. To keep a call on hold longer than 10 minutes, release the held call within 10 minutes and then place the call on hold again.

Deskset setup

Speed dial setup

The deskset has 10 speed dial locations where you can store the telephone numbers you wish to dial using fewer keys than usual. You can store up to 32 digits in each location. The first five locations can be accessed by using only the speed dial keys. To access the remaining five locations, press **LOWER** and then the speed dial key for the desired location.

To enter, edit or delete a speed dial number:

1. When the deskset is not in use, press the **Menu** softkey.
2. Press **▲DIR** or **▼CID** to scroll to **Speed dial setup**. Press the **Select** softkey.
3. Press **▲DIR** or **▼CID** to choose a desired speed dial location, then press the **Select** softkey.
4. Use the dialing keys to enter or edit the telephone number up to 32 digits. If you want to delete the entry, erase all the digits.
 - Press **◀** or **▶** to move the cursor to the left or right.
 - Press the **Pause** softkey to insert a dialing pause (a **P** appears).
 - Press **X/DELETE** to backspace and delete digits.
 - Press and hold X/DELETE to delete all digits.
5. Press the **Save** softkey to save the setting. There is a confirmation tone.

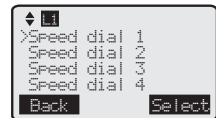

NOTES:

- See page 21 for instructions on calling a speed dial number.
- The speed dial memory and the directory are independent, so setting up speed dial numbers does not decrease your directory storage space.

Customer support

Use this feature to display the AT&T website.

1. When the deskset is not in use, press the **Menu** softkey.
2. Press **▲DIR** or **▼CID** to scroll to **Customer support**. Press the **Select** softkey.
3. To exit, press the **Back** softkey.



Deskset basic operation

The telephone comes programmed to use line 1 (default primary line) for outgoing calls when you do not press a line key. (To change the primary line, see **Line selection** on page 16.) When you answer a call, the telephone automatically selects the ringing line.

Line indicators

Each of the four indicators on **LINE 1-LINE 4** indicates the status of the corresponding telephone line.

- On when the corresponding line is in use.
- Flashes slowly when the line is on hold.
- Flashes slowly when there is a transferred call on the corresponding line.
- Flashes slowly when there is an incoming auto attendant transferred call on the corresponding line.
- Flashes rapidly when there is an incoming call on the corresponding line.

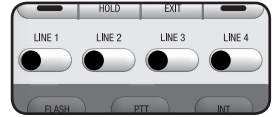

Make a call

To make a call using the corded handset:

1. Lift the corded handset.

-OR-

To override automatic line selection, press **LINE 1-LINE 4** for the desired line, and then lift the corded handset.

2. Wait for a dial tone, then enter the telephone number. The screen displays the elapsed time as you talk (in hours, minutes and seconds).

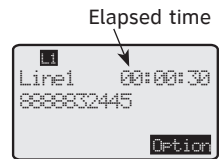

To make a call using the speakerphone:

1. Press **SPEAKER** on the deskset.

-OR-

To override automatic line selection, press **LINE 1-LINE 4** for the desired line.

2. Wait for a dial tone, then enter the telephone number. The screen displays the elapsed time as you talk (in hours, minutes and seconds).

To make a call using the corded headset:

Make sure a corded headset is connected to the deskset (page 12).

1. Press **HEADSET** on the deskset.

-OR-

To override automatic line selection, press **LINE 1-LINE 4** for the desired line, and then press **HEADSET**.

2. Wait for a dial tone, then dial the number. The screen displays the elapsed time as you talk (in hours, minutes and seconds).

Deskset basic operation

On hook dialing (predialing)

To predial using the corded handset:

1. Enter the telephone number.
 - Press **X/DELETE** to make corrections when entering the telephone number.
2. Lift the corded handset to dial.

-OR-

To override automatic line selection, press **LINE 1-LINE 4** for the desired line, then lift the corded handset.

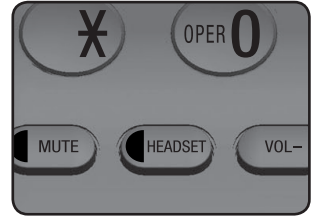

To predial using the speakerphone:

1. Enter the telephone number.
 - Press **X/DELETE** to make corrections when entering the telephone number.
2. Press **SPEAKER** to dial.

-OR-

To override automatic line selection, press **LINE 1-LINE 4** for the desired line.

To predial using the corded headset:

1. Enter the telephone number.
 - Press **X/DELETE** to make corrections when entering the telephone number.
2. Press **HEADSET** on the deskset to dial.

-OR-

To override automatic line selection, press **LINE 1-LINE 4** for the desired line, then press **HEADSET**.

Deskset basic operation

Dial a speed dial number

1. Press the desired speed dial key.

-OR-

Press **LOWER** and then the desired speed dial key.

2. Lift the corded handset, or press the **Call** softkey, **▶** **SPEAKER** or **HEADSET**.

-OR-

To override automatic line selection, press **LINE 1- LINE 4** for the desired line and use the speakerphone. If you want to use the corded handset, lift it from the deskset. If you want to use the corded headset, press **HEADSET**.



NOTE: If there is no telephone number stored in the speed dial location, **No number** displays.

Answer a call

To answer a call using the corded handset:

- Lift the corded handset.

To answer a call using the speakerphone:

- Press **▶** **SPEAKER**.

To answer a call using the corded headset:

- Press **HEADSET**.

End a call

To end a call using the corded handset:

- Place the corded handset on the deskset.

To end a call using the speakerphone:

- Press **▶** **SPEAKER**.

To end a call using the corded headset:

- Press **HEADSET** on the deskset.



NOTE: The elapsed time is not affected by accessing services from your telephone service provider, such as call waiting.

Deskset basic operation

Switch among the corded handset, the speakerphone and the corded headset

To switch from the corded handset to the speakerphone/corded headset:

1. While you are using the corded handset on a call, press **SPEAKER** or **HEADSET**.
2. Put the corded handset back to the deskset.

To switch from the speakerphone/corded headset to the corded handset:

- While you are using the speakerphone or corded headset on a call, pick up the corded handset to continue the call.

Temporary ringer silencing

Press **MUTE** while the telephone is ringing to silence the ringer temporarily on the deskset only. This turns off the ringer without disconnecting the call. The next incoming call rings normally at the preset volume.



Last number redial

The last 10 telephone numbers dialed (up to 32 digits) are stored in the redial memory of the deskset.

To view the 10 most recently dialed numbers:

1. Press the **Redial** softkey to enter the redial list and display the most recently called number.
2. Press **▲DIR** or **▼CID** to browse.
3. Press the **Back** softkey to exit the redial list.

To redial a number:

- To dial the displayed number, lift the corded handset, or press **SPEAKER** or **HEADSET**.
- OR-**

To override automatic line selection, press **LINE 1-LINE 4** for the desired line and use the speakerphone. If you want to use the corded handset, lift it from the deskset. If you want to use the corded headset, press **HEADSET**.

 **NOTE:** If there are no numbers on the redial list, the deskset displays **Redial list empty**.

Deskset basic operation

To save a redialed number in the directory:

1. When the desired number displays, press the **Save** softkey.
2. The deskset displays **Enter phone #**.
 - Use the dialing keys (page 40) to edit the number, if necessary.
 - Press ◀ or ▶ to move the cursor to the left or right.
 - Press **X/DELETE** to backspace and delete a digit.
 - Press and hold **X/DELETE** to delete all the digits.
 - Press the **Pause** softkey to enter a dialing pause (a **P** appears).
 - Press **FLASH** to enter a flash.
3. Press the **Next** softkey. The deskset displays **Enter name**. Use the dialing keys to enter a name.
 - Use the dialing keys (page 40) to enter a name.
 - Press ◀ or ▶ to move the cursor to the left or right.
 - Press **X/DELETE** to backspace and delete a character.
 - Press and hold **X/DELETE** to delete all characters.
4. Press the **Save** softkey to confirm. There is a confirmation tone.



To delete a redialed number:

- When the screen displays the desired number, press **X/DELETE** to delete the number from the redial memory. The deskset displays **Deleted**. There is a confirmation tone.

Options while on calls

Volume control

While on a call, press **VOL+** or **VOL-** to adjust the listening volume.



NOTES:

- The corded headset and corded handset volume settings are the same, but the speakerphone volume setting is independent.
- You hear a triple beep when you have reached the minimum or maximum volume level.



Call waiting

If you subscribe to call waiting service with your telephone service provider, you hear a beep when someone calls while you are already on a call.

1. Press **FLASH** to put your current call on hold and take the new call.
2. Press **FLASH** at any time to switch back and forth between calls.



NOTES:

- If you miss a call while the line is in use, the caller ID of the missed call displays for 15 seconds after your current conversation ends.
- For more information on caller ID with call waiting, see page 44.

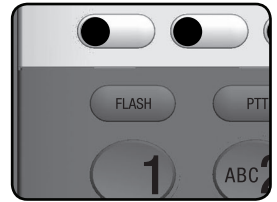

Mute

Use this feature during a telephone conversation to silence the microphone. You can hear the caller, but the caller cannot hear you.

To mute a call:

- Press **MUTE**. When mute is on, the **MUTE** light flashes and the screen flashes **-MUTE**.

To take a call off mute:

- Press **MUTE** again and resume speaking.



NOTE: Transferring a call, changing lines or putting a call on hold also cancels the mute function.



Options while on calls

Call privacy

For call privacy, you can also block all other system handsets and the main telephone base from joining a phone conversation (see page 27 for instructions for joining a call).

To enable call privacy:

- During a call, press the **Option** softkey and then press the **Select** softkey to choose **Privacy ON**. The screen displays **-PRIV**. Any other extensions are dropped and no extensions can join the call. If another extension tries to access the line you are using, its screen displays **Privacy**.



To cancel call privacy:

- During a call, press the **Option** softkey and then press the **Select** softkey to choose **Privacy OFF**. The message **-PRIV** disappears from the screen. Other extensions can now join the call by pressing the appropriate line key.



NOTES:

- Call privacy is automatically canceled when you end or transfer a call.
- You cannot set call privacy during intercom or conference calls.
- Call privacy applies only to system telephones. It does not affect non-system phones using the same line(s).

Options while on calls

Record a call

Use this feature to record a two-way phone conversation during a call. The recording is treated the same as memos and is always marked as a new message in the mailbox. However, the message indicator **LD** does not flash for new or missed recorded calls. You cannot record a conference call or an intercom call. You cannot use another line while you are recording a phone conversation.

To record a call:

1. While on a call, press the **Option** softkey.
2. Press **▲DIR** or **▼CID** to scroll to **Record call on**. Press the **Select** softkey.
3. The recording starts and the system activates call privacy. The screen displays **-PRIV** and **-REC**, and the timer starts counting while recording.
4. To stop recording and continue the call, press the **Option** softkey and then press the **Select** softkey to choose **Record call off**. The system saves the conversation into the deskset mailbox.



-OR-

The recording ends when you disconnect the call.

While recording a phone conversation, the other party hears a short beep when the recording begins and once each minute during the recording. To ensure compliance with the state and federal regulations regarding the recording of a telephone call, you should inform the caller that you are recording the call before you start recording.

To play back a memo or phone conversation:

Play memos or two-way phone conversations the same way as messages are played (see **Message playback** on page 58).



NOTES:

- Call privacy is automatically on when recording a call.
- Calls that you record use the same memory as the answering system. Recording long conversations uses up space available for recording normal messages. Please see **Remaining space** in your SynJ SB67118/SB67138 user's manual.
- When the memory of the answering system is full, the screen displays **Memory is full**.

Options while on calls

Hold

Use this feature to hold one line while accessing another, or as part of the conference and call transfer features.

While on a call, press **HOLD**. The **LINE 1-LINE 4** indicator for the line on hold flashes slowly in red. After the call has been on hold for more than three minutes, a beep sounds every 30 seconds. (See **Hold reminder** on page 17 to turn off this feature).

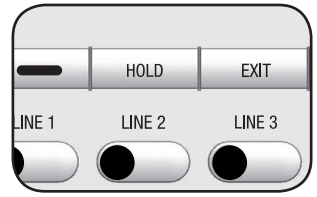

If you are using the speakerphone, the speakerphone turns off automatically when you press **HOLD**.

To resume the call, press **LINE 1-LINE 4** of the call on hold.



NOTES:

- A call on hold after 10 minutes is automatically forwarded to the auto attendant, even if the auto attendant is not activated. To keep a call on hold longer than 10 minutes, release the held call within 10 minutes and then place the call on hold again.
- You cannot put an intercom call on hold.

Switch among lines

You can switch among lines during an outside call:

1. Press **LINE 1-LINE 4** of another telephone line to make or answer another call. The current call is put on hold automatically.
2. To return to the first call, press the original **LINE 1-LINE 4**. The second line is put on hold automatically.

Join a call in progress

Use this feature to join an ongoing call on any line that does not have call privacy set (see **Call privacy** on page 25 for more information). The corresponding line icon appears on the screen when the line is in use.

- Press and hold the desired **LINE 1-LINE 4** on the deskset to join the call, which becomes a three-way conference (see page 28).



NOTE: When you try to join an ongoing call on a line with call privacy on, the screen displays **Privacy** and you hear four beeps.

Options while on calls

Chain dialing

While you are on a call, you can initiate a dialing sequence from the numbers in the directory.

Chain dialing can be useful if you wish to access other numbers (such as bank account numbers or access codes) from the directory.

To access the directory while on a call:

1. During the call, press **▲DIR**, then press **▲DIR** or **▼CID** to review the directory.
2. To dial the displayed number, press the **Call** softkey. To exit without making changes, press the **Back** softkey and continue the conversation.

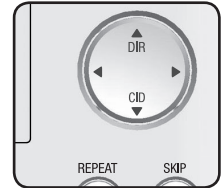

NOTES:

- You cannot edit a directory entry while on a call. See page 43 for more details about the directory.
- If there is no entry in the directory, the screen displays **Directory empty** and you can continue your call.

Three-way conference calls

You can set up a three-party call by using two lines at the same time. You can also join an intercom call with a call on an outside line. The outside line call must be established first because an intercom call cannot be placed on hold.

To make a three-way conference call:

1. Make or answer an outside call.
2. Press **HOLD** and call someone on another line, or start an intercom connection.

-OR-

Call someone on another line, or intercom someone. The first line is automatically put on hold.

3. Press the **Conf** softkey at any time to begin the three-way conference.

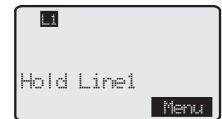

To talk privately on the outside call:

1. Press **HOLD** to place both lines on hold.
2. Press **LINE 1-LINE 4** to talk privately with the person on that line.
3. Press the **Conf** softkey to resume the conference call.

Options while on calls

To talk privately on the intercom call:

1. Press **HOLD** to talk privately with the person on that intercom call. The external line is automatically placed on hold.
2. Press the **CONF** softkey to resume the conference call.

To drop one line:

1. Press **LINE 1-LINE 4** to activate the line you want to drop. Place the corded handset on the deskset or press **🔊 SPEAKER** to hang up. The other line is put on hold automatically.
2. Press **LINE 1-LINE 4** to retrieve the call on hold and lift the handset on the deskset.

To drop the intercom call:

- Press **LINE 1-LINE 4** to activate the external call. The intercom call drops automatically.

To end a conference call:

- Place the corded handset on the deskset or press **🔊 SPEAKER** to hang up. The call does not terminate until all extensions hang up.



NOTES:

- If an internal party hangs up, the ongoing call becomes a two-way conversation.
- You cannot make any conference calls if all four telephone lines are in use.
- If you are experiencing difficulty in using the conference features on this telephone, please consider using AT&T's complete line of teleconference services to find a solution that best meets your needs. AT&T TeleConference Services reduces travel time and expenses while increasing productivity wherever people are located, enabling you to host truly virtual meetings and share important information in real time. To sign up for AT&T TeleConference Services, go to:

www.att.com/orderconference for details.

COVM

COVM (central office voicemail)

If you subscribe to voicemail service with your telephone service provider, and you want the deskset to indicate when you have new voicemail, turn the **COVM** indicator on. When a phone line receives any new voicemail messages, **COVM LX** (X is the telephone line number) displays on the screen.

If you do not subscribe to voicemail service or want to disable the indicator, turn off the **COVM** feature.

1. When the deskset is not in use, press the **MENU** softkey.
2. Press **▲DIR** or **▼CID** to scroll to **COVM**. Press the **Select** softkey.
3. The deskset displays **>COVM on/off**. Press the **Select** softkey again.
4. Press **▲DIR** or **▼CID** to select **On** or **Off**.
5. Press the **Save** softkey to save the setting and return to the previous menu. There is a confirmation tone.



NOTE: If there are messages from the telephone service provider when you turn on this feature, the screen displays the **COVM** indicator.

Intercom

You can use the intercom feature for conversations with a cordless handset, a cordless headset or the SB67118/SB67138 main telephone base. When the system is making one or more external calls, the deskset can make intercom calls with a cordless handset, a cordless headset or the main telephone base.

Make an intercom call

1. Press the **INT** key on the deskset.
2. Press **▲DIR** or **▼CID** to choose a destination device.

-OR-

Press ***** (star key) for the main telephone base, **1-0** for extension 1-10, and **#** (pound key) for all extensions.

3. Press the **Select** softkey.
4. The screen displays **Calling X:Handset X** (**X** represents the extension number [1-0], **Handset X** represents the handset name), **Calling *:Base** or **Calling All**.

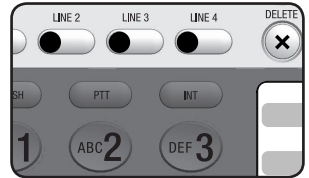

NOTES:

- Before the intercom call is answered, you can cancel the intercom by pressing **▶ SPEAKER**, lifting the corded handset and putting it back to the deskset, or by pressing the corresponding **LINE 1-LINE 4** to resume a call.
- The intercom call is automatically canceled if it is unanswered after one minute.
- Press **MUTE** to temporarily silence the intercom ringer.
- When you choose **All** in the menu, all extensions and the telephone base ring. The intercom call is established with the first extension to answer.
- If a line is in use, pressing **INT** places the line on hold and activates the intercom.

Intercom

Answer an incoming call during an intercom call

If you receive an incoming outside call during an intercom call, there is an alert tone. To answer the call, press **LINE 1-LINE 4**. The intercom call ends automatically.

Answer an intercom call

When you receive an intercom call, you hear a ringing tone and your screen displays **Call X: Handset X** (X represents the extension number [1-0], **Handset X** represents the handset name) or **Call *:Base**. Answer an intercom call just as you would answer a normal call.

End an intercom call

End an intercom just as you would end a normal call.

Call transfer using intercom

You can transfer a call to the main telephone base or any other system device.

1. During a call, press **INT**.
2. Press **▲DIR** or **▼CID** to scroll to the desired device. Press the **Select** softkey.

-OR-

Press **1-0** for the desired extension number, ***X** (star key) for the main telephone base, or **#** (pound key) for all.

3. The outside call is put on hold and the deskset shows **Calling X:Handset X Hold Line X**, **Calling *: Base Hold Line X**, or **Calling All Hold Line X**.
4. The other device rings and its screen shows **Call X:Deskset X**.
5. Answer an intercom call just as you would answer a normal call, or press **INT**. The outside call is still on hold and both screens now show **Intercom**. You can now have a private conversation.

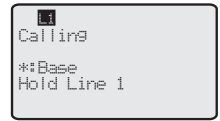

6. From this intercom call, you have the following options:
 - You can let the other handset or main telephone base join you on the outside call in a three-way conversation. Press the **Conf** softkey on the deskset.
 - You can transfer the outside call to the other extension before the intercom call is answered (blind transfer). Place your corded handset back in the deskset, then the other extension automatically connects to the outside call.
 - You can return to the outside call. Press the **LINE 1-LINE 4** key on the deskset.
 - The other person can .Press the line key on the original extension to resume the outside call.

NOTES:

- Before the intercom call is answered, you can cancel the call transfer and return to the external call by pressing the corresponding line key on the deskset.
- When a transferred call is not answered after 30 seconds, the transfer is canceled. The external call returns to the deskset and is on hold. When the hold reminder is turned on, the deskset beeps every 30 seconds. Press the **LINE 1-LINE 4** key to answer the external call.

Call transfer using intercom

You can also transfer a call to the general mailbox.

1. During a call, press **INT**.
2. Press **▲DIR** or **▼CID** to scroll to **Mailbox**. Press the **Select** softkey.
3. The caller is prompted to leave a message in the general mailbox.



NOTE: For details on how to operate the mailbox, see the SynJ SB67118/SB67138 user's manual.

Push to talk (PTT) intercom

You can directly broadcast your voice to the speakerphone of any extension. The extension you called can respond by pressing the **PTT** key to begin a two-way communication. Up to five pairs of PTT calls can exist at a time.

PTT to the main telephone base or a system device

1. When the deskset is not in use, press the **PTT** key.
2. Press **▲DIR** or **▼CID** to choose the desired device.
3. Press and hold **PTT** until the deskset shows **PTT to: X:Handset X Release PTT key to stop** (X represents the extension number [1-0]; **Handset X** represents the handset name) or **PTT to: *:Base Release PTT key to stop**. When the connection is made, both the caller and the destination party hear two beeps.
4. Speak towards the deskset speakerphone while continuing to hold down the **PTT** key. Your voice is broadcast to the desired extension.
5. Release the **PTT** key after speaking. There is a three-second PTT wait state with **-MUTE** slowly flashing on the screen. During the PTT wait state, if necessary, you can press and hold the PTT key to continue speaking towards the speakerphone.
6. The destination party can respond by converting the PTT call to an intercom call (see page 37).

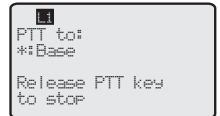
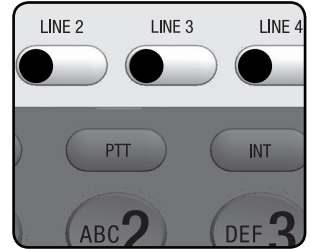

NOTE: When the destination device is on an intercom or outside call, you hear a busy tone and the deskset displays **Busy**.

Push to talk (PTT) intercom

PTT to all devices

1. When the deskset is not in use, press the **PTT** key. Press **▲DIR** or **▼CID** to choose **#: All**. Then press and hold **PTT** until the deskset displays **PTT to: All Release PTT key to stop**.

-OR-

When the deskset is not in use, press and hold the **PTT** key until the deskset displays **PTT to: All Release PTT key to stop**.

2. When the connection is made, both the caller and the destination parties hear two beeps.
3. Speak towards the deskset speakerphone. Your voice is broadcast to all extensions. Release the **PTT** key after speaking. There is a three-second PTT wait state with **-MUTE** slowly flashing on the screen and the **MUTE** indicator flashing. During the PTT wait state, if necessary, you can press and hold the **PTT** key to continue to speak towards the deskset speakerphone.
4. Any system device can reply.

Push to talk (PTT) intercom

Answer a PTT call

1. When you hear two beeps, the screen displays **PTT from: X:Handset X** (**X** represents the extension number [1-0], **Handset X** represents the handset name) or **PTT from: *:Base**.
2. To respond to a new PTT call, press **INT** on the deskset to convert the call to a two-way intercom call.

Convert a PTT call to an intercom call

When you have initiated a PTT call to a system device, the destination device can convert the PTT call to a two-way intercom call.

1. After two beeps, the destination device displays **PTT from: X:Deskset X** (**X** represents the extension number [1-0], **Deskset X** represents the deskset name).
2. Press **INT** on the destination device to convert the call to a two-way intercom call.



NOTE: If the PTT call is sent to all handsets, the intercom call is established with the first one who presses **INT**.

End a PTT call

Press **EXIT** to end the incoming PTT call.

About the directory

Use the directory to store names and phone numbers. The directory in the deskset is independent from the main telephone base and all other registered devices. Changes made to the directory on the main telephone base and other registered handsets apply only to that particular device.

Capacity

The directory of the deskset can store up to 100 entries, with a maximum of 16 alphanumeric characters (including spaces) for names and 32 digits for telephone numbers. A convenient search feature can help you quickly find and dial numbers (page 42).

When there are already 100 entries, the screen shows **Memory is full**. You cannot store a new number until you delete one. If you try to view the directory entries when there are no entries, the screen displays **Directory empty**.

Exit the directory

On the deskset, press **EXIT** to cancel an operation and return to idle mode.

If you pause for too long while creating or reviewing an entry, the procedure times out and you have to begin again.

Create directory entries

Create a new directory entry

Use the following steps to store a name and number in the directory.

1. When the deskset is not in use, press the **Menu** softkey and then press the **Select** softkey to choose **Directory**.

-OR-

Press **DIR** on the deskset.

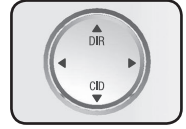

2. When the deskset displays **Directory empty** or **Directory XX entries**, press the **Add** softkey to add an entry.



3. Enter a telephone number (up to 32 digits) using the dialing keys when prompted.

- Press **◀** or **▶** to move the cursor to the left or right.
- Press **X/DELETE** to backspace and delete a digit.
- Press and hold X/DELETE to erase all digits.
- Press the **Pause** softkey to enter a dialing pause (a **P** appears; see page 40).



4. Press the **Next** softkey to move on to the name. Enter the name when prompted.

- Use the dialing keys to enter a name (up to 16 characters). Each time you press a key, the character on that key appears. Additional key presses produce other characters on that key. See the chart on page 40.
 - Press **◀** or **▶** to move the cursor to the left or right.
 - Press **X/DELETE** to backspace and delete a character.
 - Press and hold X/DELETE to erase all characters.
 - Press **0** once to add a space.



5. Press the **Save** softkey to save the setting and return to the previous menu. There is a confirmation tone. The name and the telephone number appear on the screen.



NOTE: If the telephone number in the directory exceeds 16 digits, **<** appears in front of the telephone number. Press **<** to move towards the beginning of the telephone number or press **>** to move towards the end of the telephone number.

Create directory entries

Number key	Characters by number of key presses								
	1	2	3	4	5	6	7	8	9
1	&	'	()	,	-	.	/	1
2	a	b	c	A	B	C	2		
3	d	e	f	D	E	F	3		
4	g	h	i	G	H	I	4		
5	j	k	l	J	K	L	5		
6	m	n	o	M	N	O	6		
7	p	q	r	s	P	Q	R	S	7
8	t	u	v	T	U	V	8		
9	w	x	y	z	W	X	Y	Z	9
0	space	0							
*	*								
#	#								

Store a pause in a directory entry

You may need to include a pause in a directory number to enable access to automated telephone systems.

- When you wish to enter a pause in the dialing sequence, press the **Pause** softkey to store a pause (a **P** appears). Each pause counts as one digit. If you want to save the number in the directory, press the **Save** softkey.

Store a flash in a directory entry

You may need a flash to access certain custom-calling services in a directory number.

- When you wish to enter a flash in the dialing sequence, press the **FLASH** key. An **F** appears in the telephone number. Each flash counts as one digit. If you want to save the number in the directory, press the **Save** softkey.

Review directory

Review directory entries

1. When the deskset is not in use, press the **Menu** softkey and then press the **Select** softkey to choose **Directory**.

-OR-

Press **DIR** on the deskset.

2. When the deskset displays **Directory empty** or **Directory XX entries**, press **▲DIR** or **▼CID** to browse through the directory. Entries appear alphabetically by the first letter in the name.



Search directory

Search by name

Follow the steps below to search for directory entries on the deskset.

1. When the deskset is not in use, press the **Menu** softkey and then press the **Select** softkey to choose **Directory**.

-OR-

Press **▲DIR** on the deskset.

2. When the deskset displays **Directory empty** or **Directory XX entries**, press **▲DIR** or **▼CID** to browse through the directory. Entries appear alphabetically by the first letter in the name.
3. When a name appears, press the dialing keys (**2-9**) to start a name search.
 - The directory shows the first name beginning with the first letter associated with the dialing key if there is an entry in the directory beginning with that letter. If there is no entry matching the letter you pressed, it remains in the current entry.
4. To see other names starting with the letters on the same dialing key, keep pressing the key. The names appear in alphabetical order.



For example, if you have the names **Jennifer**, **Jessie**, **Kevin** and **Linda** in your directory:

- If you press **5 (JKL)** once, you see **Jennifer**.
- If you press **5 (JKL)** twice, you see **Kevin**.
- If you press **5 (JKL)** three times, you see **Linda**.
- If you press **5 (JKL)** four times, you see **Jennifer**.
- To view **Jessie**, press **▼** while **Jennifer** is displayed.

Dial, delete or edit directory entries

You can dial, delete or edit a directory entry (name and number) when it is shown on the deskset screen. You can use the directory review or name search (pages 41-42) to show an entry.

Display dial

When a number is displayed on the screen, you can dial the number by lifting the corded handset, pressing the **Call** softkey, **▶ SPEAKER, HEADSET** or **LINE 1-LINE 4** for the desired line.

Delete an entry

When a directory entry appears, press **X/DELETE** on the deskset to delete the displayed entry from the directory. You cannot retrieve a deleted entry.



Delete all entries

1. When the deskset is not in use, press the **Menu** softkey and then press the **Select** softkey to choose **Directory**.

-OR-

Press **▲DIR** on the deskset.

2. When the deskset displays **Directory XX entries**, press the **Del All** softkey.

3. When the deskset displays **Delete entire directory?** Press the **Yes** softkey to confirm, or the **No** softkey to exit.

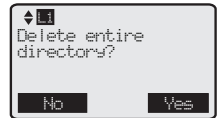

NOTE: You cannot retrieve deleted entries.

Edit an entry

1. When a directory entry appears, press the **Edit** softkey.
2. Follow Step 3 to Step 5 on page 39.



NOTE: If the telephone number in the directory exceeds 16 digits, < appears in front of the telephone number on the editing screen. Press ◀ to move towards the beginning of the telephone number or press ▶ to move towards the end of the telephone number.

About caller ID

This deskset supports caller ID services that most telephone service providers offer. Caller ID allows you to see the name, number, date and time of calls. Depending on your service subscription, you might see the caller's number, or the caller's name and number from the telephone service provider after the first or second ring. Caller ID information might not be available for every incoming call. Callers may intentionally block their names and/or telephone numbers.

This product can provide information only if both you and the caller are in areas offering caller ID service and if both telephone service providers use compatible equipment.

Information about caller ID with call waiting

Caller ID with call waiting lets you see the name and telephone number of the caller before answering the telephone, and while on another call.



There are fees associated with caller ID services. In addition, this service might be called by different names (such as caller ID with visual call waiting) by different telephone service providers and might not be available in all areas.

It might be necessary to change telephone service to use this feature. Contact your telephone service provider if:

- You have both caller ID and call waiting, but as separate services (you might need to combine these services).
- You only have caller ID service, or only call waiting service.
- You do not subscribe to caller ID or call waiting services.



NOTES:

- You can use this telephone with regular caller ID service, or you can use this telephone's other features without subscribing to caller ID or combined caller ID with call waiting service.
- The format of telephone numbers displayed depends on the home and local area codes you set (see **Area codes** in your SynJ SB67118/SB67138 user's manual for explanations and instructions for setting area codes).

Caller ID Information

How the caller ID information (call log) works

The deskset stores caller ID information for the last 50 incoming calls. Entries are stored in reverse chronological order. The telephone deletes the oldest entry when the log is full to make room for a new call.

Each extension has an independent call log. Deleting the caller ID information on any one extension does not affect the caller ID information on other extensions.

If you answer a call before the information appears on the screen, it will not be saved in the call log.

Review the caller ID information to see who called, to easily return the call, or to copy the caller's name and number into your directory.

The **NEW CALL** indicator turns on and **XX Missed call(s)** appears when there are new call log entries (including new or missed calls).

Call log empty appears when there are no records in the call log.

The time and date of the call and the caller's name and telephone number are included in the display.

Caller ID information appears on the screen as the telephone rings, or until the caller hangs up, or until the call has been answered at another extension, or until the call ends.

If you subscribe to caller ID service, this phone automatically resets the time and date each time new call information is received. You can also set the time and date manually (see **Set date and time** in your SynJ SB67118/ SB67138 user's manual).

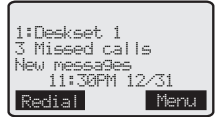

Screen display of the deskset

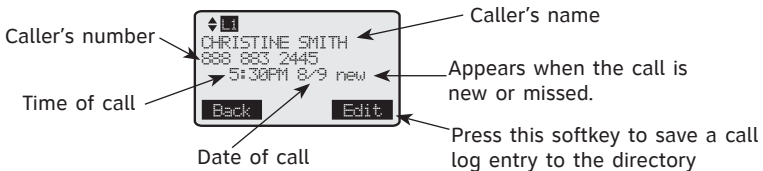

NOTES:

- The caller ID information might not be available for every incoming call. Callers might intentionally block their names and/or telephone numbers.
- Each entry can store up to 32 digits for the telephone number and 16 characters for the name. If the telephone number has more than 16 digits but less than or equal to 24 digits, only the last 17 digits appear. If the telephone number has more than 24 digits, only the 8th to 24th digits (17 digits) appear. In order to view the entire number, you must first save the entry to the directory (see page 48). If the telephone number has more than 32 digits, it is not saved or shown in the call log.

Caller ID operation

Memory match

If the incoming telephone number is an exact match with a telephone number in your directory, the name that appears on the screen matches the corresponding name in your directory.

For example, if Christine Smith calls, her name appears as **Chris** if this is how you entered it into your directory.



NOTE: The number shown is in the format from the telephone service provider. It usually delivers 10-digit telephone numbers (area code plus telephone number). The telephone system ignores the area code when searching for a match and displays the name of the first corresponding number from the directory.

Missed (new) calls indicator

When the deskset is not in use and has new missed calls, its screen shows **XX Missed calls**.

All new missed entries are counted as missed calls. Each time you review a call log entry with the icon **new**, the number of missed calls decreases by one. When all the entries in the call log become old (have been reviewed), the system removes the missed calls alert from the display, and the **NEW CALL** indicator turns off.

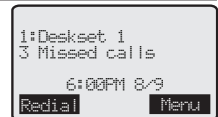

Review the caller ID information

1. When the deskset is not in use, press **▼CID**.

-OR-

When the deskset is not in use, press the **Menu** softkey. Press **▲DIR** or **▼CID** to scroll to **Call log**. Press the **Select** softkey.

2. When the deskset displays **XX Missed calls**, press **▲DIR** or **▼CID** to review the call log. The call log entries are stored in reverse chronological order starting with the most recent entry.

3. To exit without making changes, press **EXIT**.

Caller ID operation

View dialing options

Although the incoming call log entries have 10 digits (the area code plus the seven-digit number), in some areas, you may need to dial only the seven digits, 1 plus the seven digits, or 1 plus the area code plus the seven digits. You can change and store the number of digits that you dial in the call log.

While reviewing the call log, press **#** (pound key) repeatedly on the deskset to show different dialing options for local and long distance numbers before dialing or saving the telephone number in the directory.

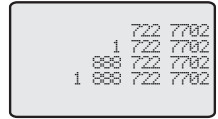

Dial a call log entry

1. When in the call log, press **▲DIR** or **▼CID** to browse.
2. When the desired number displays, lift the handset, or press **▶SPEAKER** or **HEADSET**.

-OR-

To override automatic line selection, press **LINE 1-LINE 4** for the desired line and use the speakerphone. If you want to use the corded handset, lift it from the deskset. If you want to use the corded headset, press **HEADSET**.

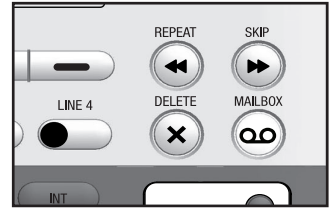

Delete the call log entries

To delete a call log entry:

1. When in the call log, press **▲DIR** or **▼CID** to browse to the number you wish to delete.
2. Press **X/DELETE** to delete the shown entry from the caller ID history.

To delete all call log entries:

1. When the deskset is not in use, press **▼CID**.

-OR-

When the deskset is not in use, press the **Menu** softkey. Press **▲DIR** or **▼CID** to scroll to **Call log**. Press the **Select** softkey.

2. Press the **Del All** softkey. The deskset displays **Delete all calls?**
3. Press the **Yes** softkey to delete all call log entries. The deskset displays **All deleted**.

-OR-

Press the **No** softkey to exit.



Caller ID operation

Save a call log entry to the directory

1. When in the call log, press **▲DIR** or **▼CID** to browse.
2. When the desired entry displays, press the **Edit** softkey.
3. When the **telephone number** appears:
 - Press the dialing keys to add digits (page 40).
 - Press **X/DELETE** to erase a digit.
 - Press and hold X/DELETE to erase all digits.
 - Press **◀** or **▶** to move the cursor to the left or right.
 - Press the **Pause** softkey to enter a dialing pause (a **P** appears).
4. Press the **Next** softkey to move to the name.
 - Press the dialing keys to add characters (page 40).
 - Press **X/DELETE** to erase a character.
 - Press and hold X/DELETE to erase all characters.
 - Press **◀** or **▶** to move the cursor to the left or right.
 - Press **0** once to enter a space.
5. Press the **Save** softkey to save the new directory entry. There is a confirmation tone. The name and the telephone number appear.
 - If the entry is already saved in the directory, the screen returns to the call log.
 - If there is no caller ID information, you hear an error tone. The number is unable to save.



-OR-

To exit without making changes, press **EXIT**.

NOTE: You will need to change how a caller ID number is dialed if the entry does not appear in the correct format. Caller ID numbers might appear with an area code that might not be necessary for local calls, or without a 1 that might be necessary for long distance calls (see **View dialing options** on the previous page for more information).

Reasons for missing caller ID information

Reasons for missing caller ID information

There are also occasions when other information or no information shows for various reasons:

Screen message	Reason
Private caller	The caller prefers not to show the telephone number and name.
Unknown caller	Your telephone service provider cannot determine the caller's name and telephone number. Calls from other countries may also generate this message.

Deskset voicemail box (answering system)

The deskset has a private voicemail box that is different from the general mailbox on the main telephone base or handset. The voicemail messages for the deskset can also be accessed from the main telephone base.

Answering system and voicemail

The deskset has separate indicators for two different types of voice messages: those left on its built-in answering system and those left at your service provider's voicemail (fees may apply). Your telephone's built-in answering system messages and voicemail messages are separate. Each alerts you to new messages differently.



- If you turn on the **COVM** feature (see **COVM** on page 30 for more information) and the **COVM** icon displays on the deskset, your telephone service provider is indicating that it has new voicemail for you. To listen to your voicemail, you typically dial an access number provided by your telephone service provider, followed by a security code or PIN.

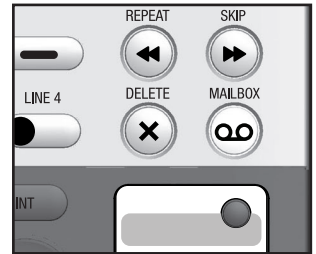

- To listen to messages recorded on your digital answering system, press **OO/MAILBOX** on the deskset (see page 57).

Some service providers bundle or combine multiple services like voicemail and call waiting, so you may not be aware that you have voicemail. To check what services you have and how to access them, contact your telephone service provider.

To use your voicemail service rather than your answering system, turn off your answering system. To use your answering system rather than your voicemail service, contact your telephone service provider to deactivate your voicemail service. You can also use your telephone answering system and voicemail together by setting your built-in answering system to answer before voicemail answers as described below. To learn how to program your voicemail settings, contact your telephone service provider. Then, if you are on a call, or if the answering system is busy recording a message and you receive another call, the second caller can leave a voicemail message.

Set your answering system to answer calls at least two rings earlier than your voicemail is set to answer. For example, if your voicemail answers after six rings, set your answering system to answer after four rings. Some voicemail providers may program the delay before answering calls in seconds instead of rings. In this case, allow six seconds per ring when determining the appropriate setting.

Set the answering system to answer automatically

You can set each of the four lines to automatically answer incoming calls on the main telephone base in two different ways. See the SynJ SB67118/SB67138 user's manual for more information.

General mailbox:

The called line rings on every extension for each incoming call. If there is no answer, the caller is prompted to leave a message in the general mailbox, which a person at any handset or the deskset can review. The general mailbox stores incoming messages, memos and recorded calls.

Auto attendant:

The called line for each incoming call flashes on every extension, but does not ring. Instead, the auto attendant answers. The caller can specify an extension or leave a general mailbox message. When the auto attendant directs a call to an extension but it is not answered, the auto attendant prompts the caller to leave a message for that extension or try another extension.

Answering system capacity

The maximum recording time of all handsets, desksets and main telephone base is 180 minutes. The actual recording time depends on individual message characteristics. Individual messages can be up to three minutes. Messages remain available for review until you delete them.

Each recorded announcement requires system memory, so we suggest recording a brief announcement in order to leave more space for messages.



NOTE: You cannot record an announcement when the telephone system is out of space. You will hear a two-beep alert tone and voice prompt "*Memory is full.*" Please refer to **Remaining space** in the SynJ SB67118/SB67138 user's manual.

Voice prompts

The system provides voice prompts to guide you through the setup procedures.

Deskset mailbox setup

Deskset mailbox overview

Your deskset has its own mailbox which is different from the general mailbox on the main telephone base. If you turn on the auto attendant on the main telephone base and fast answer mode on the deskset, the caller is able to leave a message on the deskset mailbox after two rings. If you do not turn on the fast answer mode on the deskset, the answering system picks up the call after five rings and allows the caller to leave a message on the deskset mailbox, or call another extension or the operator.

New message indication

When you have new messages in the deskset mailbox, the screen displays **New messages**. In addition, the new message indicator  flashes.

If the notify alert is turned on (see pages 54-55), you will receive a phone call at the telephone number you chose each time a new message has been recorded.

There is no new message indication on the deskset when messages are left in the general mailbox.

Fast answer mode

You can set the number of times your extension rings before the auto attendant asks the caller to leave you a message or choose another extension. The number of rings can be two (on) or five (off). The default is five rings.

1. When the deskset is not in use, press **00/MAILBOX**.
2. Press **▲DIR** or **▼CID** to scroll to **Fast answer mode**. Press the **Select** softkey.
3. Press **▲DIR** or **▼CID** to select **On** or **Off**.
4. Press the **Save** softkey to save the setting and return to the previous menu. There is a confirmation tone. To exit without making changes, press the **Back** softkey.

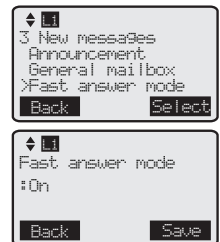

Deskset mailbox setup

Set access code (remote access code) and mailbox security

You can enter a four-digit number (**0000-9999**) to allow remote access to your deskset mailbox from any touch-tone telephone. Unless you change it, the remote access code is **0000**.

This access code is also used for mailbox security. If you turn this feature on, you must enter the access code each time you access the deskset mailbox. If you do not want to enter the access code every time you access the deskset mailbox, turn this feature off.

1. When the deskset is not in use, press the **Menu** softkey.
2. Press **▲DIR** or **▼CID** to scroll to **Mailbox setup**.
3. Press the **Select** softkey twice to select **Set access code**.
4. Use the dialing keys to enter a four-digit number.
 - Press **X/DELETE** to backspace and delete a digit.
5. Press the **Next** softkey.
6. When the deskset displays **Mailbox security**, press **▲DIR** or **▼CID** to scroll to **On** or **Off**.
7. Press the **Save** softkey to save the setting. There is a confirmation tone.



NOTES:

- The access code must have four digits. You can only press the **Next** softkey after you have entered four digits.
- You will hear an error tone if you enter an access code that is already assigned. Then the deskset displays **Please enter another access code**.

Deskset mailbox setup

Notify alert

Use this feature to receive notification calls to any phone number you set (such as a cellular phone or paging device) after a new message has been recorded to the deskset mailbox. To receive notification calls, you must save the number you wish to be notified at to the deskset, and then set the system to call this number after it finishes recording a message.

If the number called has caller ID service, there will be an indication of the notification call. When you receive a notification call, you hear about 15 seconds of silence; then the call is ended. There is no message sent and the call is only made once. If the call is not picked up within three rings, the telephone base cancels the call. You may not receive the call if the number you set is busy, not available or off during the call.

To set an alert number:

1. When the deskset is not in use, press the **Menu** softkey.
2. Press **▲DIR** or **▼CID** to scroll to **Mailbox setup**. Press the **Select** softkey.
3. Press **▲DIR** or **▼CID** to scroll to **Notify alert**. Press the **Select** softkey.
4. Press the **Select** softkey again to select **Alert call #**.
5. Use the dialing keys to enter the phone number (up to 32 digits) you want to notify.
 - Press **◀** or **▶** to move the cursor to the left or right.
 - Press **X/DELETE** to backspace and delete a digit.
 - Press and hold **X/DELETE** to delete all digits.
6. Press the **Save** softkey to save the setting and return to the previous menu. There is a confirmation tone. To exit without making changes, press the **Back** softkey.

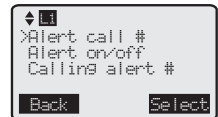

To turn alert on or off:

1. Follow Step 1 through Step 3 above.
2. Press **▲DIR** or **▼CID** to scroll to **Alert on/off**. Press the **Select** softkey.
3. Press **▲DIR** or **▼CID** to scroll to **On** or **Off**.
4. Press the **Save** softkey to save the setting and return to the previous menu. There is a confirmation tone. To exit without making changes, press the **Back** softkey.

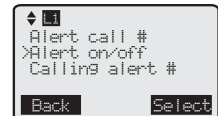

Deskset mailbox setup

To confirm the call alert number set correctly:

You can confirm whether the system can successfully call the alert number that you entered.

1. Follow Step 1 through Step 3 in **To set an alert number** on page 54.
2. Press ▲**DIR** or ▼**CID** to scroll to **Calling alert #**. Press the **Select** softkey. The screen displays **Press SPKR to confirm the alert call**. You can press the **Back** softkey to exit.
3. Press 🔊 **SPEAKER** on the deskset. The deskset dials the number you set and the phone being notified rings.
4. Press 🔊 **SPEAKER** again to end the test. The screen returns to idle mode.

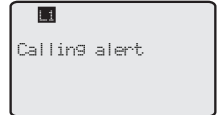
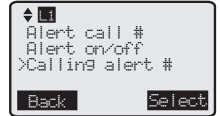

NOTE: When you turn on **Notify alert** before you enter the alert number, **Please set alert #** appears on the screen.

Deskset mailbox setup

Deskset announcement setup

The announcement is the greeting callers hear when calls are answered by the deskset mailbox.

The deskset has the default announcement *"Hello, please leave a message after the tone."* You can use this announcement, or replace it with your own recording.

The announcement can be up to two minutes.

To play the default announcement:

1. When the deskset is not in use, press **QD/MAILBOX**.
2. If you have new messages in the deskset mailbox, it announces, *"Mailbox X, you have X new messages."*

-OR-

If you do not have new messages in the deskset mailbox, it announces, *"Mailbox X, you have no new messages."*

3. Press **▲DIR** or **▼CID** to select **Annemnt setup**. Press the **Select** softkey and the current announcement plays. Press the **OK** softkey to exit.

To record a new personal announcement:

1. Follow the steps in **To play the default announcement** above.
2. Press the **Change** softkey to record a new announcement. The screen displays **Record annemnt**.
3. Press the **Start** softkey. The system announces, *"Record after the tone. Press Stop when you are done."* There is a reminder beep. The timer starts counting.
4. Press the **Stop** softkey when finished. The timer stops and the deskset automatically plays the recorded announcement.
5. Press the **OK** softkey to exit.

-OR-

Press the **Change** softkey to record the announcement again if desired.



Message playback

From the deskset, you can play the messages in the deskset mailbox and the general mailbox.

If you have new messages, the system plays them (in chronological order) automatically when you access the mailbox.

When playback begins, the total number of messages is announced. Before each message, you hear the date and time of the recording. After the last message, you hear *"End of messages."*

To play new messages in the deskset mailbox:

- When the deskset is not in use, press **OO/MAILBOX** and the new messages play automatically.

To play all old messages in the deskset mailbox:

1. When the deskset is not in use, press **OO/MAILBOX**.
2. Press the **Select** softkey to choose **Play all**.

To play new messages in the general mailbox:

1. When the deskset is not in use, press **OO/MAILBOX**.
2. Press **▲DIR** or **▼CID** to scroll to **General mailbox**.
3. Press the **Select** softkey.

If you have new messages in the general mailbox, it announces, *"This is the general delivery mailbox. You have X new messages."* Then the deskset starts to play the new messages.

-OR-

If you do not have new messages in the general mailbox, it announces, *"This is the general delivery mailbox. You have no new messages."*

To play all old messages in the general mailbox:

1. When the deskset is not in use, press the **OO/MAILBOX**.
2. Press **▲DIR** or **▼CID** to scroll to **General mailbox**. Press the **Select** softkey.

If you have new messages in the general mailbox, it announces, *"This is the general delivery mailbox. You have X new messages."* Then the deskset starts to play the new messages.

-OR-

If you do not have new messages in the general mailbox, it announces, *"This is the general delivery mailbox. You have no new messages."*

3. Press the **Select** softkey again to choose **Play all**.

When you are in the general mailbox, press **▲DIR** or **▼CID** to scroll to **Go to HS MBox** and press the **Select** softkey to return to the deskset mailbox.

Message playback

Options during playback

When a message is playing, you can skip, repeat, or delete the message, or adjust the playback volume.

When a message is playing on the deskset:

- Press **VOL+** or **VOL-** to adjust the message playback volume.
- Press **▶** or **▶▶/SKIP** to skip to the next message.
- Press **◀** or **◀◀/REPEAT** to repeat the message. Press twice to hear the previous message.
- Press **X/DELETE** to delete the message. The system announces, "Message deleted."
- Press the **Back** softkey to stop the playback and return to the mailbox.
- Press **EXIT** to stop the playback and exit.

Transfer messages

When a message in the deskset mailbox is playing, you can transfer the message to the main telephone base, a registered extension or all registered extensions.

1. Press **INT** on the deskset while the deskset is playing a message.
2. The deskset announces, "Enter the mailbox number."
Press **▲DIR** or **▼CID** to scroll to the desired device, then press the **Select** softkey.



-OR-

Press **X** for the main telephone base, **1-0** for a registered extension or **#** (pound key) for all registered extensions.

3. The deskset displays **Msg transferred to mailbox X** and announces, "Message transferred to Mailbox X."

A copy of the message automatically transfers to the main telephone base, the desired extension or all extensions. The general mailbox retains the original copy of the message.



NOTE: The mailbox of the desired extension keeps only one copy even if you send the same message twice.

Message playback

Call back to the mailbox message caller

During message playback, you can call back the message caller by pressing **Line 1-Line 4**,  **SPEAKER, HEADSET** or the **Call** softkey, or lifting the corded handset.



NOTE: If there is no caller ID information of the caller, you only hear a dial tone when you press **Line 1-Line 4**, , **SPEAKER, HEADSET**, the **Call** softkey, or lift the corded handset.

Delete all old messages

You can only delete old (reviewed) messages. You cannot delete new messages until you review them. You cannot retrieve deleted messages.

To delete all old messages in the deskset mailbox:

1. When the deskset is not in use, press **QD/MAILBOX**.
2. Press **▲DIR** or **▼CID** to scroll to **Delete all old**. Press the **Select** softkey.
3. The screen displays **Delete all old messages?** Press the **Yes** softkey to confirm or press the **No** softkey to return to the previous screen.

To delete all old messages in the general mailbox:

1. When the deskset is not in use, press **QD/MAILBOX**.
2. Press **▲DIR** or **▼CID** to scroll to **General mailbox**. Press the **Select** softkey.
3. Press **▲DIR** or **▼CID** to scroll to **Delete all old**. Press the **Select** softkey.
4. The screen displays **Delete all old messages?** Press the **Yes** softkey to confirm or press the **No** softkey to return to the previous screen.



NOTE: If there are new missed messages in the deskset mailbox, the new message indicator still flashes after you delete all old messages.

Record and deliver memos

Memos are messages you record into the deskset mailbox. You can save, play back, and delete them like incoming messages. You can record a memo as a reminder to yourself, or send a message to other extensions using the answering system.

To record and deliver a memo to the general mailbox or a handset mailbox:

1. When the deskset is not in use, press **OO/MAILBOX**.
2. Press **▲DIR** or **▼CID** to scroll to **Deliver**. Press the **Select** softkey.
-OR-
Press **▲DIR** or **▼CID** to scroll to **General mailbox**. Press the **Select** softkey. Press **▲DIR** or **▼CID** to scroll to **Deliver** and then press the **Select** softkey.
3. The system announces, *"Enter the mailbox number."*
4. Press **▲DIR** or **▼CID** to scroll to the desired device.
-OR-
Press **✕** for the main telephone base, **1-0** for a registered extension or **#** (pound key) for all registered extensions.
5. Press the **Select** softkey.
6. The deskset displays **Record message**. Press the **Start** softkey to record a message. The deskset announces, *"Hello! Please leave a message after the tone. Press **Stop** when you are done."* You can record a memo up to three minutes. The system does not save memos shorter than three seconds.
7. Speak facing the deskset microphone to record.
8. Press the **Stop** softkey to stop recording. The recorded memo plays automatically.

 **NOTE:** If you record a memo when the memory is full, the screen displays **Message is full**.

Remote access

You can access your deskset answering system remotely by dialing your telephone number from any touch-tone telephone.

To remotely reach the answering system:

1. Dial your telephone number from any touch-tone telephone.
2. When the system answers, enter the four-digit remote access code (**0000** is the default code; see page 53 to change it).

The system automatically announces the number of messages (new and/or old) if there are any, and then begins to play them.

3. You can also enter the following remote commands.

Remote commands:

1	<ul style="list-style-type: none">• Press to play all messages.• Press to record a new announcement (during announcement playback).
2	<ul style="list-style-type: none">• Press to accept the recorded announcement (during announcement playback).
3	<ul style="list-style-type: none">• Press to delete the current message (during playback).• Press to delete the recorded announcement (during announcement playback).
4	<ul style="list-style-type: none">• Press to repeat the current message (during playback).• After you hear "Repeat", press 4 again within five seconds to listen to the previous message (during playback).
5	<ul style="list-style-type: none">• Press to repeat the list of remote commands.• Press to stop and return to the remote commands (during playback).• Press to end recording (during recording announcement).
6	<ul style="list-style-type: none">• Press to skip to the next message (during playback).
7	<ul style="list-style-type: none">• Press to transfer the current message (during playback). Then press the handset number (1-0) or ✳ (star key) for the base, and then # (pound key) to transfer a message to the destination mailbox. (This option is only available for transferring messages.)
8	<ul style="list-style-type: none">• Press to change the personal announcement (only available to deskset mailboxes).
9	<ul style="list-style-type: none">• Press to change to the general delivery mailbox (only available to deskset mailboxes).
✳	<ul style="list-style-type: none">• Press to end the call.

Remote access

4. Hang up or press **X** to end the call.

Cut out the remote access wallet card at the back of this user's manual for quick reference.







NOTES:

- If the auto attendant is active, enter your extension number. Wait for the outgoing announcement to begin, then enter the remote access code.
- If you do not enter a valid remote access code, the answering system will answer the call as usual, but the sound from pressing the dialing keys and the environment will be recorded as a message and stored in the general mailbox.
- If you do not enter any remote access code, the answering system announces, *"Thank you for calling,"* and the call ends.
- When there is no new message or all the new messages are played during remote access, you hear a help menu listing all features and commands. If there is no command after the help menu is played three times, the call ends automatically.
- If you press **4** within five seconds after each message playback starts, the previous message plays instead of repeating the current message.

Screen icons, indicator tones and lights

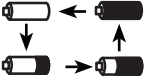
Screen icons

	<p>Line indicator - on when the corresponding line is in use.</p> <p>Flashes when the corresponding line is on hold.</p>
	<p>Ringer off - the deskset ringer is off.</p>
	<p>New answering system message - indicates you have new answering system messages.</p>
	<p>Backup battery status - the backup battery is charging (animated display). Becomes solid when the battery is fully charged.</p>
	<p>Backup battery status - flashes when the backup battery is low and needs charging.</p>



Indicator tones

One short beep	<ul style="list-style-type: none"> The Hold reminder is active. A call has been on hold for more than three minutes. The telephone conversation recording begins. During the recording, you will hear one beep per minute.
One triple beeps	<ul style="list-style-type: none"> You are pressing VOL+ or VOL- when the volume has reached its highest or lowest setting. Your directory or call log is empty. You enter more than 32 digits or characters while predialing or editing an entry. Deskset registration fails to register to the main telephone base.
Four beeps	<ul style="list-style-type: none"> You cannot intercom with an extension when it is set to Privacy ON. When you end an intercom call with the other party, the deskset beeps.

Indicator lights

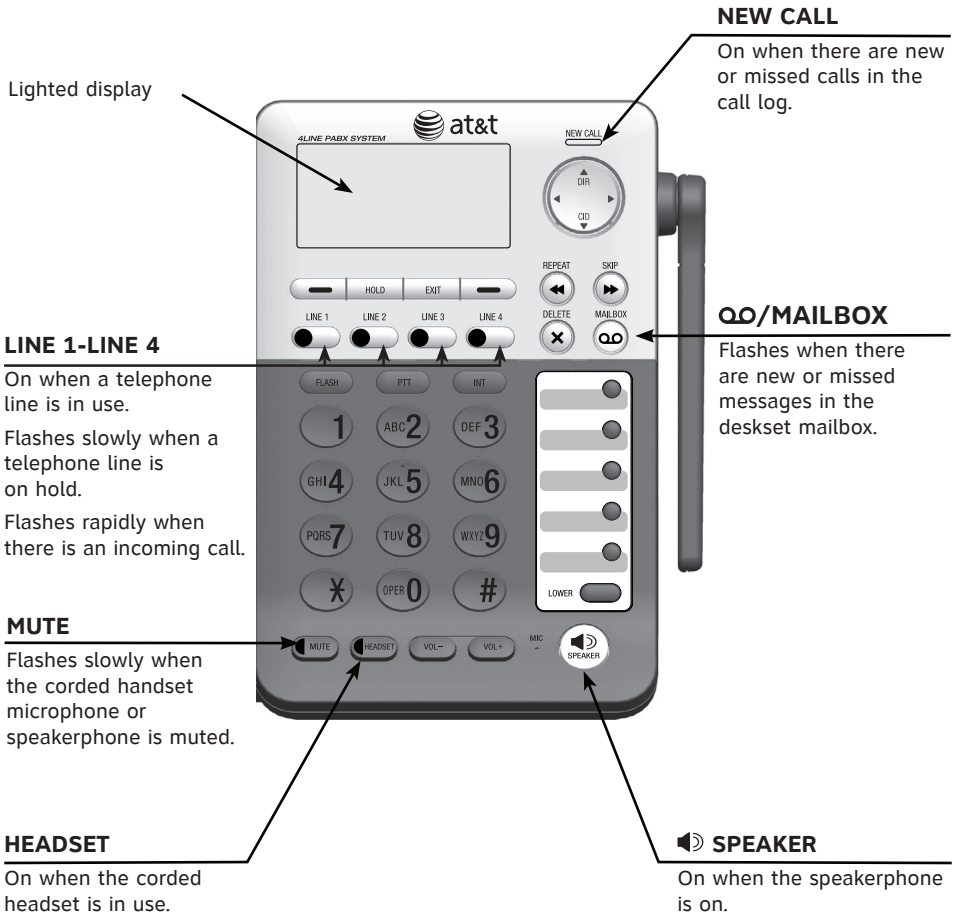

Deskset display screen messages

All deleted	All directory entries, call log entries or old messages in the general or deskset mailbox are erased.
Busy	Failed intercom or conference call (there are already two cordless handsets or desksets being used).
Call **Base	The main telephone base is calling.
Call X:Handset X	Another system handset is calling.
Call log empty	There are no entries in the caller ID history.
Calling All	The deskset is calling all registered devices (for intercom calls).
Calling **Base	The deskset is starting an intercom call with the main telephone base.
Calling X:Handset X	The deskset is starting an intercom call with a cordless handset.
COVM L1 L2 L3 L4	There are new voicemail messages on the corresponding lines.
Check AC power	The power cord is not connected.
Deleted	A call log entry, a redial number or a directory entry was deleted.
Directory empty	There are no directory entries.
Ended	You have just ended a call.
———Line X——— Incoming call	There is an incoming call.
Line X	The telephone line X is in use.
Low battery	The backup battery is low on power.
Memory is full	The directory is full. You cannot save new entries unless you delete some current entries.
Message is full	The system memory is full. You cannot record new messages unless you delete some old messages.
-MUTE	The microphone is off.
Msg. transferred to mailbox X	A message has been transferred from the general mailbox to a particular private mailbox.
No link to the base. Please walk closer to the base and try again	The deskset has lost communication with the main telephone base.

Deskset display screen messages

Please enter another access code.	The access code you are trying to save already exists in the system.
Please set alert #	You are trying to confirm the alert number or set the notify alert on or off before you set the alert number.
Press MENU on MAIN base, select Registration & then Register HS. Then press Start .	The deskset is not registered to the telephone base. Follow the procedure for registration.
Press SPKR to confirm the alert call	Press the deskset speakerphone to call the alert call number.
-PRIV	The call is in privacy mode.
Privacy	The deskset tried to join a call in which call privacy is activated.
PTT To: All Release PTT key to stop	You are using push to talk (PTT) intercom feature to call all registered devices. Release PTT to stop.
PTT To: *1Base Release PTT key to stop	You are using push to talk (PTT) intercom feature to call the main telephone base. Release PTT to stop.
PTT To: X:Handset X Release PTT key to stop	You are using push to talk (PTT) intercom feature to call Handset X . Release PTT to stop.
-REC	The call is being recorded.
Redial list empty	The redial list is empty.
Registered	The deskset registration is successful.
Registration failed	The deskset registration failed.
Speed dial X No number	You cannot initiate a speed dial without a telephone number stored in that speed dial location.
The system is busy. Please try again later.	The system resources are all occupied.
This mailbox is in use	You are trying to access a mailbox that is in use.
XX Missed calls	There are new calls in the caller ID history.

Troubleshooting

If you have difficulty with your telephone, please try the suggestions below. For customer service, visit our website at **www.telephones.att.com** or call **1 (888) 915-2007**. In Canada, dial **1 (866) 288-4268**.

My deskset doesn't work at all.

- Make sure the power cord is securely plugged in.
- Make sure you plug the telephone line cord securely and firmly into the main telephone base and the telephone wall jack.
- Reset the deskset. Unplug the electrical power. Wait for approximately 15 seconds, then plug it back in. Allow up to one minute for the deskset to reset.
- Other electronic products such as HAM radios and other DECT phones can cause interference with your cordless devices. Try installing your phone as far away as possible from these types of electronic devices.
- You may need to purchase a backup battery to make the deskset work in the event of a power failure. Please refer to **Backup battery installation** on page 6 and **Backup battery charging** on page 7 in this user's manual.

I cannot get a dial tone from the corded handset.

- Try all the suggestions above.
- Make sure you plug the handset cord securely and firmly into the handset jack on the deskset and the corded handset.
- Your line cord might be malfunctioning. Try installing a new line cord.

I cannot dial out.

- Try all the suggestions above.
- Make sure you have a dial tone before dialing. The corded handset might take a second or two to connect the deskset and produce a dial tone. This is normal. Wait an extra second before dialing.
- Eliminate any background noise. Noise from a television, radio or other appliances might cause the telephone to not dial out properly. If you cannot eliminate the background noise, first try muting the corded handset before dialing, or dialing from another room with less background noise.
- If the other telephones in your building are having the same problem, contact your telephone service provider.

Troubleshooting

My deskset isn't performing normally.

- Make sure you plug the power cord securely into the deskset. Plug the power adapter into a different working electrical outlet without a wall switch.
- Move the deskset closer to the main telephone base. You might have moved out of range.
- Reset the deskset. Unplug the electrical power. Wait for 15 seconds then plug it back in. Allow up to one minute for the deskset to reset.
- Other electronic products such as HAM radios and other DECT phones can cause interference with your deskset. Try installing your deskset as far away as possible from these types of electronic devices.

The backup battery does not hold a charge.

- Make sure you plug the power cord securely into the deskset. Plug the power adapter into a different working electrical outlet without a wall switch.
- Unplug the electrical power. Wait for 15 seconds then plug it back in. Allow up to one minute for the main telephone base to reset.
- You might need to purchase a new battery. Refer to **Backup battery installation** on page 6 and **Backup battery charging** on page 7 in this user's manual.

I experience poor sound quality when using the speakerphone.

- For increased sound quality while using the telephone speakerphone, place the deskset on a flat surface.
- Excessive background noise will cause a speakerphone to fade in and out. Try controlling the background noise by turning off any audio devices near the speakerphone. Also, try to avoid interrupting the person at the other end of the conversation while they are speaking. If background noise cannot be controlled, you should stop speakerphone operation and return to normal corded handset mode.
- When using a speakerphone, controlling background noise in your environment is essential. While you are listening to your party, press **MUTE** to temporarily turn your microphone off. When it is your turn to speak, remember to press **MUTE** again to turn the microphone on.

Troubleshooting

I get noise, static, or weak signals even when I'm near the main telephone base.

- If you subscribe to high-speed Internet service (DSL - digital subscriber line) through your telephone lines, you must install a DSL filter between each telephone line cord and telephone wall jack. The filter prevents noise and caller ID problems as a result of DSL interference. Please contact your DSL service provider for more information about DSL filters.
- You may be able to improve the performance of your deskset by installing your new telephone base as far as possible from any other existing cordless telephone system that may already be installed.
- Other electronic products such as HAM radios and other DECT phones can cause interference with your cordless devices. Try installing your deskset as far away as possible from these types of electronic devices.
- Do not install the deskset near a microwave oven or on the same electrical outlet. You might experience decreased performance while the microwave oven is operating.
- If you plug your phone in with a modem or a surge protector, plug the phone (or modem/surge protector) into a different location. If this does not solve the problem, relocate your phone or modem farther apart from one another, or use a different surge protector.
- Move your main telephone base to a higher location. The phone might have better reception in a high area.
- If the other phones in your building are having the same problem, contact your telephone service provider (charges may apply).

I hear other calls while using my telephone.

- Disconnect the main telephone base from the telephone jack, and plug in a different telephone. If you still hear other calls, call your telephone service provider (charges may apply).

Troubleshooting

My deskset does not ring when I receive a call.

- Make sure that the ringer is not turned off (page 13).
- Make sure you plug in the power cord securely.
- The deskset may be too far from the main telephone base.
- You may have too many extension telephones on your telephone line to allow all of them to ring simultaneously. Try unplugging some of the other telephones.
- The layout of your building might be limiting the operating range. Try moving the main telephone base to another location, preferably to a higher location.
- If other telephones in your building are having the same problem, contact your telephone service provider (charges may apply).
- Test a working telephone at the telephone jack. If another telephone has the same problem, contact your telephone service provider (charges may apply).
- Other electronic products such as HAM radios and other DECT phones can cause interference with your cordless phone. Try installing your phone as far away as possible from these types of electronic devices.
- Your line cord might be malfunctioning. Try installing a new line cord.

Troubleshooting

My calls cut in and out while I'm using my deskset.

- Other electronic products such as HAM radios and other DECT phones can cause interference with your deskset. Try installing your phone as far away as possible from these types of electronic devices.
- Do not install the deskset near a microwave oven or on the same electrical outlet. You might experience decreased performance while the microwave oven is operating.
- If you plug the main telephone base in with a modem or surge protector, plug it (or modem/surge protector) into a different location. If this does not solve the problem, relocate the main telephone base or modem farther apart from one another, or use a different surge protector.
- Relocate the main telephone base to a higher location. The main telephone base might have better reception when installed in a high area.
- If other telephones in your building are having the same problem, contact your telephone service provider.
- Excessive background noise will cause a speakerphone to fade in and out. Try controlling the background noise by turning off any audio devices near the speakerphone. Also, try to avoid interrupting the person at the other end of the conversation while they are speaking. If background noise cannot be controlled, you should stop speakerphone operation and return to normal handset mode.
- When using a deskset speakerphone, controlling background noise in your environment is essential. While you are listening to your party, press **MUTE** to temporarily turn your microphone off. When it is your turn to speak, remember to press **MUTE** again to turn the microphone on.

My caller ID isn't working.

- Caller ID is a subscription service. You must subscribe to this service from your telephone service provider for this feature to work on your phone.
- The caller must be calling from an area that supports caller ID.
- Both your and your caller's telephone service providers must use caller ID compatible equipment.
- If you subscribe to high-speed Internet service (DSL - digital subscriber line) through your telephone lines, you must install a DSL filter between each telephone line cord and telephone wall jack. The filter prevents noise and caller ID problems resulting from DSL interference. Please contact your DSL service provider for more information about DSL filters.

Troubleshooting

The telephone system does not receive caller ID when on a call.

- Make sure you subscribe to caller ID with call waiting features from your telephone service provider. Caller ID feature works only if both you and the caller are in areas offering caller ID service, and if both telephone service providers use compatible equipment.

The answering system is recording incomplete messages.

- If a caller leaves a very long message, part of it may be lost when the system disconnects the call after three minutes.
- If the caller pauses for longer than six seconds, the system stops recording and disconnects the call.
- If the system memory becomes full while recording a message, the system stops recording and disconnects the call.
- If the caller's voice is very soft, the system may stop recording and disconnect the call.

I have difficulty hearing messages.

- Press **VOL+** to increase the speaker volume on the deskset.

The answering system does not answer after the correct number of rings.

- Make sure the auto attendant is on. Please refer to **Turn the auto attendant on** in the SynJ SB67118/SB67138 user's manual.
- Make sure the memory of the answering system is not full. Refer to **Remaining space** in the SynJ SB67118/SB67138 user's manual. When the answering system memory is full, it does not record new messages until some old messages are deleted.
- If you subscribe to voicemail service, change the number of rings so that your answering system answers before your voicemail answers. To determine how many rings activate your voicemail, contact your telephone service provider (charges may apply).
- If there is a fax machine connected to the same telephone line, try disconnecting the fax machine. If that solves the problem, consult your fax machine documentation for information on compatibility with answering systems.

Troubleshooting

The answering system does not record messages.

- Make sure the answering system is turned on.
- Make sure the memory of the answering system is not full. Refer to the **Remaining space** section in your SynJ SB67118/SB67138 user's manual. When the answering system memory is full, it does not record new messages until some old messages are deleted.
- If you subscribe to voicemail service, change the number of rings so that your answering system answers before your voicemail answers. To determine how many rings activate your voicemail, contact your telephone service provider.
- If there is a fax machine connected to the same telephone line, try disconnecting the fax machine. If that solves the problem, consult your fax machine documentation for information on compatibility with answering systems.

The system does not respond to remote commands.

- Make sure to enter your remote access code correctly (page 61).
- Make sure you are calling from a touch-tone telephone. When you dial a number, you should hear tones. If you hear clicks, the telephone is not a touch-tone telephone and cannot activate the answering system.
- The answering system may not detect the remote access code while your announcement is playing. Try waiting until the announcement is over before entering the code.
- There may be interference on the telephone line you are using. Press the dialing keys firmly.

The outgoing announcement is not clear.

- When you record your announcement, make sure you speak in a normal tone of voice, about nine inches from the deskset.
- Make sure there is no background noise (TV, music, etc.) while recording.

COVM shows on the screen display and I do not know why.

- Your telephone has voicemail indication that is separate from the built-in answering system. If **COVM** appears on the display, then your telephone has received a signal from your telephone service provider. Contact your telephone service provider for more information on how to access your voicemail.

I cannot retrieve voicemail messages.

- Your telephone has both a built-in answering system and voicemail indication. They are independent features and each alerts you to new messages differently (page 50). If you subscribe to voicemail service from your telephone service provider, contact your telephone service provider for more information on how to access your voicemail.

Common cure for electronic equipment.

If the deskset does not seem to be responding normally, do the following (in the order listed):

- Disconnect the power to the main telephone base and the deskset.
- Disconnect the backup battery in the deskset.
- Wait a few minutes.
- Connect power to the main telephone base and the deskset.
- Install the backup battery again.
- Wait for the deskset to reestablish its connection with the main telephone base. Allow up to one minute for this to take place.

Appendix
Maintenance

Taking care of your telephone

- Your deskset contains sophisticated electronic parts, so you must treat it with care.
- Avoid rough treatment.
- Place the deskset down gently.
- Save the original packing materials to protect your deskset if you ever need to ship it.

Avoid water

- You can damage your deskset if it gets wet. Do not use the deskset in the rain, or handle it with wet hands. Do not install the deskset near a sink, bathtub or shower.

Electrical storms

- Electrical storms can sometimes cause power surges harmful to electronic equipment. For your own safety, take caution when using electric appliances during storms.

Cleaning your telephone

- Your deskset has a durable plastic casing that should retain its luster for many years. Clean it only with a soft cloth slightly dampened with water or mild soap.
- Do not use excess water or cleaning solvents of any kind.

Remember that electrical appliances can cause serious injury if used when you are wet or standing in water. If the deskset should fall into water, DO NOT RETRIEVE IT UNTIL YOU UNPLUG THE POWER CORD AND TELEPHONE LINE CORDS FROM THE WALL. Then pull the unit out by the unplugged cords.

Important safety information



This symbol is to alert you to important operating or servicing instructions that may appear in this user's manual. Always follow basic safety precautions when using this product to reduce the risk of injury, fire, or electric shock.

Safety information

- Read and understand all instructions in the user's manual. Observe all markings on the product.
- Avoid using a telephone during a thunderstorm. There may be a slight chance of electric shock from lightning.
- Do not use the telephone to report a gas leak in the vicinity of the leak. Under certain circumstances, a spark may be created when the adapter is plugged into the power outlet, or when the handset is replaced in its cradle. This is a common event associated with the closing of any electrical circuit. The user should not plug the phone into a power outlet, and should not put a charged handset into the cradle, if the phone is located in an environment containing concentrations of flammable or flame-supporting gases, unless there is adequate ventilation. A spark in such an environment could create a fire or explosion. Such environments might include: medical use of oxygen without adequate ventilation; industrial gases (cleaning solvents; gasoline vapors; etc.); a leak of natural gas; etc.
- Do not use this product near water, or when you are wet. For example, do not use it in a wet basement or shower, or next to a swimming pool, bathtub, kitchen sink, or laundry tub. Do not use liquids or aerosol sprays for cleaning. If the product comes in contact with any liquid, unplug any line or power cord immediately. Do not plug the product back in until it has dried thoroughly.
- Install this product in a protected location where no one can trip over any line or power cords. Protect cords from damage or abrasion.
- If this product does not operate normally, see the **Troubleshooting** section on pages 67-74 of this user's manual. If you cannot solve the problem, or if the product is damaged, refer to the **Limited warranty** section on pages 80-81. Do not open this product except as directed in your user's manual. Opening the product or reassembling it incorrectly may expose you to hazardous voltages or other risks.
- Replace the backup battery only as described in your user's manual (see page 6). Do not burn or puncture batteries — they contain caustic chemicals.
- This power adapter is intended to be correctly oriented in a vertical or floor mount position. The prongs are not designed to hold the plug in place if it is plugged into a ceiling, an under-the-table or cabinet outlet.



Caution: Use only the power adapter provided with this product. To obtain a replacement, visit our website at **www.telephones.att.com** or call **1 (888) 915-2007**. In Canada, dial **1 (866) 288-4268**.

Important safety information

Especially about cordless telephones

- **Privacy:** The same features that make a cordless telephone convenient create some limitations. Telephone calls are transmitted between the telephone base and the handset by radio waves, so there is a possibility that your cordless telephone conversations could be intercepted by radio receiving equipment within range of the cordless handset. For this reason, you should not think of cordless telephone conversations as being as private as those on corded telephones.
- **Electrical power:** The telephone base of this cordless telephone must be connected to a working electrical outlet which is not controlled by a wall switch. Calls cannot be made from the handset if the telephone base is unplugged, switched off or if the electrical power is interrupted.
- **Potential TV interference:** Some cordless telephones operate at frequencies that may cause interference to TVs and VCRs. To minimize or prevent such interference, do not place the telephone base of the cordless telephone near or on top of a TV or VCR. If interference is experienced, moving the cordless telephone farther away from the TV or VCR will often reduce or eliminate the interference.
- **Rechargeable batteries:** This product contains nickel-metal hydride rechargeable batteries. Exercise care in handling batteries in order not to create a short circuit with conductive material such as rings, bracelets, and keys. The battery or conductor may overheat and cause harm. Observe proper polarity between the battery and the battery charger.
- **Nickel-metal hydride rechargeable batteries:** Dispose of these batteries in a safe manner. Do not burn or puncture. Like other batteries of this type, if burned or punctured, they could release caustic material which could cause injury.



The RBRC™ Seal means that the manufacturer is voluntarily participating in an industry program to collect and recycle nickel-metal hydride rechargeable batteries when taken out of service within the United States. These batteries may be taken to a participating local retailer of replacement batteries or recycling center. Or you may call 1 (800) 8-BATTERY for locations accepting spent Ni-MH batteries.

Precautions for users of implanted cardiac pacemakers

Cardiac pacemakers (applies only to digital cordless telephones):

Wireless Technology Research, LLC (WTR), an independent research entity, led a multidisciplinary evaluation of the interference between portable wireless telephones and implanted cardiac pacemakers. Supported by the U.S. Food and Drug Administration, WTR recommends to physicians that:

Pacemaker patients

- Should keep wireless telephones at least six inches from the pacemaker.
- Should NOT place wireless telephones directly over the pacemaker, such as in a breast pocket, when it is turned ON.
- Should use the wireless telephone at the ear opposite the pacemaker.
WTR's evaluation did not identify any risk to bystanders with pacemakers from other persons using wireless telephones.

Especially about telephone answering systems

Two-way recording: This unit does not sound warning beeps to inform the other party that the call is being recorded. To ensure that you are in compliance with any federal or state regulations regarding recording a telephone call, you should start the recording process and then inform the other party that you are recording the conversation.

SAVE THESE INSTRUCTIONS

FCC part 68 and ACTA

This equipment complies with Part 68 of the FCC rules and with technical requirements adopted by the Administrative Council for Terminal Attachments (ACTA). The label on the back or bottom of this equipment contains, among other things, a product identifier in the format US: AAAEQ##TXXXX. This identifier must be provided to your telephone service provider upon request.

The plug and jack used to connect this equipment to premises wiring and the telephone network must comply with the applicable Part 68 rules and technical requirements adopted by ACTA. A compliant telephone cord and modular plug is provided with this product. It is designed to be connected to a compatible modular jack that is also compliant. An RJ11 jack should normally be used for connecting to a single line and an RJ14 jack for two lines. See the installation instructions in the user's manual.

The Ringer Equivalence Number (REN) is used to determine how many devices you may connect to your telephone line and still have them ring when you are called. The REN for this product is encoded as the 6th and 7th characters following the US: in the product identifier (e.g., if ## is 03, the REN is 0.3). In most, but not all areas, the sum of all RENs should be five (5.0) or less. For more information, please contact your telephone service provider.

This equipment may not be used with Party Lines. If you have specially wired alarm dialing equipment connected to telephone line, ensure the connection of this equipment does not disable your alarm equipment. If you have questions about what will disable the alarm equipment, consult your telephone service provider or a qualified installer.

If this equipment is malfunctioning, it must be unplugged from the modular jack until the problem has been corrected. Repairs to this telephone equipment can only be made by the manufacturer or its authorized agents. For repair procedures, follow the instructions outlined under the Limited Warranty.

If this equipment is causing harm to the telephone network, the telephone service provider may temporarily discontinue your telephone service. The telephone service provider is required to notify you before interrupting service. If advance notice is not practical, you will be notified as soon as possible. You will be given the opportunity to correct the problem and the telephone service provider is required to inform you of your right to file a complaint with the FCC. Your telephone service provider may make changes in its facilities, equipment, operation, or procedures that could affect the proper functioning of this product. The telephone service provider is required to notify you if such changes are planned.

If this product is equipped with a corded or cordless handset, it is hearing aid compatible.

If this product has memory dialing locations, you may choose to store emergency telephone numbers (e.g., police, fire, medical) in these locations. If you do store or test emergency numbers, please:

Remain on the line and briefly explain the reason for the call before hanging up.

Perform such activities in off-peak hours, such as early morning or late evening.

Industry Canada

Operation is subject to the following two conditions: (1) this device may not cause harmful interference, and (2) this device must accept any interference, including interference that may cause undesired operation.

The term "IC:" before the certification/registration number only signifies that the Industry Canada technical specifications were met.

The Ringer Equivalence Number (REN) for this terminal equipment is 0.1. The REN is an indication of the maximum number of devices allowed to be connected to a telephone interface. The termination on an interface may consist of any combination of devices subject only to the requirement that the sum of the RENs of all the devices does not exceed five.

This product meets the applicable Industry Canada technical specifications.

Appendix
FCC part 15

This equipment has been tested and found to comply with the requirements for a Class B digital device under Part 15 of the Federal Communications Commission (FCC) rules. These requirements are intended to provide reasonable protection against harmful interference in a residential installation. This equipment generates, uses and can radiate radio frequency energy and, if not installed and used in accordance with the instructions, may cause harmful interference to radio communications. However, there is no guarantee that interference will not occur in a particular installation. If this equipment does cause harmful interference to radio or television reception, which can be determined by turning the equipment off and on, the user is encouraged to try to correct the interference by one or more of the following measures:

- Reorient or relocate the receiving antenna.
- Increase the separation between the equipment and receiver.
- Connect the equipment into an outlet on a circuit different from that to which the receiver is connected.
- Consult the dealer or an experienced radio/TV technician for help.

Changes or modifications to this equipment not expressly approved by the party responsible for compliance could void the user's authority to operate the equipment.

This device complies with Part 15 of the FCC Rules. Operation is subject to the following two conditions: (1) this device may not cause harmful interference, and (2) this device must accept any interference received, including interference that may cause undesired operation. Privacy of communications may not be ensured when using this telephone.

To ensure safety of users, the FCC has established criteria for the amount of radio frequency energy that can be safely absorbed by a user or bystander according to the intended usage of the product. This product has been tested and found to comply with the FCC criteria. The handset may be safely held against the ear of the user. The deskset shall be installed and used such that parts of the user's body other than the hands are maintained at a distance of approximately 20 cm (8 inches) or more.

This Class B digital apparatus complies with Canadian ICES-003.

Limited warranty

The AT&T brand is used under license - any repair, replacement or warranty service, and all questions about this product should be directed to: In the United States of America, visit **www.telephones.att.com** or call **1 (888) 915-2007**. In Canada, call **1 (866) 288-4268**.

1. What does this limited warranty cover?

The manufacturer of this AT&T-branded product warrants to the holder of a valid proof of purchase ("CONSUMER" or "you") that the product and all accessories provided in the sales package ("PRODUCT") are free from defects in material and workmanship, pursuant to the following terms and conditions, when installed and used normally and in accordance with the PRODUCT operating instructions. This limited warranty extends only to the CONSUMER for products purchased and used in the United States of America and Canada.

2. What will be done if the PRODUCT is not free from defects in materials and workmanship during the limited warranty period ("materially defective PRODUCT")?

During the limited warranty period, the manufacturer's authorized service representative will repair or replace at the manufacturer's option, without charge, a materially defective PRODUCT. If the manufacturer repairs the PRODUCT, they may use new or refurbished replacement parts. If the manufacturer chooses to replace the PRODUCT, they may replace it with a new or refurbished PRODUCT of the same or similar design. The manufacturer will retain defective parts, modules, or equipment. Repair or replacement of the PRODUCT, at the manufacturer's option, is your exclusive remedy. The manufacturer will return repaired or replacement products to you in working condition. You should expect the repair or replacement to take approximately 30 days.

3. How long is the limited warranty period?

The limited warranty period for the PRODUCT extends for ONE (1) YEAR from the date of purchase. If the manufacturer repairs or replaces a materially defective PRODUCT under the terms of this limited warranty, this limited warranty also applies to repaired or replacement PRODUCT for a period of either (a) 90 days from the date the repaired or replacement PRODUCT is shipped to you or (b) the time remaining on the original one-year limited warranty; whichever is longer.

4. What is not covered by this limited warranty?

This limited warranty does not cover:

- PRODUCT that has been subjected to misuse, accident, shipping or other physical damage, improper installation, abnormal operation or handling, neglect, inundation, fire, water, or other liquid intrusion; or
- PRODUCT that has been damaged due to repair, alteration, or modification by anyone other than an authorized service representative of the manufacturer; or
- PRODUCT to the extent that the problem experienced is caused by signal conditions, network reliability or cable or antenna systems; or
- PRODUCT to the extent that the problem is caused by use with non-AT&T accessories; or
- PRODUCT whose warranty/quality stickers, PRODUCT serial number plates or electronic serial numbers have been removed, altered or rendered illegible; or
- PRODUCT purchased, used, serviced, or shipped for repair from outside the United States of America or Canada, or used for commercial or institutional purposes (including but not limited to products used for rental purposes); or
- PRODUCT returned without a valid proof of purchase (see item 6 below); or
- Charges for installation or setup, adjustment of customer controls, and installation or repair of systems outside the unit.

Limited warranty

5. How do you get warranty service?

To obtain warranty service in the United States of America, visit

www.telephones.att.com or call **1 (888) 915-2007**. In Canada, call **1 (866) 288-4268**. NOTE: Before calling for service, please review the user’s manual; a check of the PRODUCT’s controls and features may save you a service call.

Except as provided by applicable law, you assume the risk of loss or damage during transit and transportation and are responsible for delivery or handling charges incurred in the transport of the PRODUCT(s) to the service location. The manufacturer will return repaired or replaced PRODUCT under this limited warranty to you. Transportation, delivery or handling charges are prepaid. The manufacturer assumes no risk for damage or loss of the PRODUCT in transit. If the PRODUCT failure is not covered by this limited warranty, or proof of purchase does not meet the terms of this limited warranty, the manufacturer will notify you and will request that you authorize the cost of repair prior to any further repair activity. You must pay for the cost of repair and return shipping costs for the repair of products that are not covered by this limited warranty.

6. What must you return with the PRODUCT to get warranty service?

You must:

- Return the entire original package and contents including the PRODUCT to the service location along with a description of the malfunction or difficulty; and
- Include a “valid proof of purchase” (sales receipt) identifying the PRODUCT purchased (PRODUCT model) and the date of purchase or receipt; and
- Provide your name, complete and correct mailing address, and telephone number.

7. Other limitations

This warranty is the complete and exclusive agreement between you and the manufacturer of this AT&T branded PRODUCT. It supersedes all other written or oral communications related to this PRODUCT. The manufacturer provides no other warranties for this PRODUCT. The warranty exclusively describes all of the manufacturer’s responsibilities regarding the PRODUCT. There are no other express warranties. No one is authorized to make modifications to this limited warranty and you should not rely on any such modification.

State/Provincial Law rights: This warranty gives you specific legal rights, and you may also have other rights which vary from state to state or province to province.

Limitations: Implied warranties, including those of fitness for a particular purpose and merchantability (an unwritten warranty that the PRODUCT is fit for ordinary use) are limited to one year from date of purchase. Some states/provinces do not allow limitations on how long an implied warranty lasts, so the above limitation may not apply to you. In no event shall the manufacturer be liable for any indirect, special, incidental, consequential, or similar damages (including, but not limited to lost profits or revenue, inability to use the PRODUCT or other associated equipment, the cost of substitute equipment, and claims by third parties) resulting from the use of this PRODUCT. Some states/provinces do not allow the exclusion or limitation of incidental or consequential damages, so the above limitation or exclusion may not apply to you.

Please retain your original sales receipt as proof of purchase.

Technical specifications

RF frequency band	1921.536MHz - 1928.448MHz
Channels	5
Operating temperature	32°F - 122°F 0°C - 50°C
Deskset voltage (AC voltage, 60Hz)	100 Vrms - 120Vrms
Deskset voltage (AC adapter output)	6VDC @400mA
Replacement battery	3.6V 600mAH

Backup battery

Operation	Operating time*
Talk time (corded handset)	Up to 12 hours
Talk time (speakerphone/ corded headset)	Up to 7 hours
Standby	Up to 3 days

* Operating times vary depending on your actual use and the age of the battery.

DECT 6.0 digital technology

The AT&T DECT 6.0 products offer unsurpassed range performance and sound clarity. This is achieved through a unique antenna design and advances in noise-filtering technology. An independent laboratory has confirmed that AT&T DECT 6.0 products perform up to 45% better in range competitions. Now calls can be taken in the basement, backyard and garage with exceptional sound quality.

Telephone operating range

This cordless telephone operates within the maximum power allowed by the Federal Communications Commission (FCC). Even so, the deskset can communicate over only a certain distance — which can vary with the locations of the deskset, the weather, and the construction of your building.

A

AC adapter 5
Access code 53, 61
Add the deskset 8–9
Alert tones 63
Announcement 56
Answering calls 21
Answering system 50–62

B

Battery charging 7
Battery installation 6

C

Caller ID (CID) 44–49
 add entries to phone directory 48
 delete entries 47
 review entries 46
Call privacy 25
Call transfer 33–34
Call waiting 24
Chain dialing 28
Conference call 28
COVM 30
Customer support 18

D

Delete
 call log entries 47
Delete redial entries 23
Deliver a memo 60
Dialing
 directory dialing 43
 from the call log 47

Directory

 capacity 38
 create entries 39
 dial number 43
 display dial 43
 edit entries 43
 name search 42

E

Ending calls 21

F

Flash (switch hook flash) 24

H

Hold 27
Hold reminder 17

I

Incoming call, answering 21
Incoming caller ID history 46
Indicator lights 64
Indicator tones 63
Installation 4–5
Intercom 31–33

J

Join a call in progress 27

K

Key tone 15

L

Language 16
Last number redial 22
LCD contrast 15
Limited warranty 80–81
Line selection 16

Index

M

Maintenance 75
 Making calls 19
 Memory match 46
 Menu settings 13
 Message memo 60
 Message playback 57–59
 Missed calls indicator 46
 Mute 24

N

Names
 enter into directory 39
 search 42
 Navigation keys 1
 New message indication 52
 Notify alert 54

O

On hook dialing 20

P

Pause 18, 23, 39, 40, 48
 Phonebook (directory) 38
 Play back a message memo 60
 Power adapter 5
 PPT 35–37
 Predialing 20

Q

Quick reference guide 1–3

R

Receiving calls 21
 Recharging 7
 Record
 a call 26
 announcement 56
 message memo 60

Redial 22

Registration 8
 Remote access 61–62
 Review directory entries 41
 Review the caller ID information 46
 Ringer silencing 22
 Ringer tone options 14
 Ringer volume 13

S

Safety information 76–77
 Screen display messages 65–66
 Screen icons 63
 Search by name 42
 Speakerphone 19, 20, 21, 22
 Speed dial 21

T

Technical specifications 82
 Telephone operating range 82
 Temporary ringer silencing 22
 Three-way conference calls 28
 Transfer a call 33
 Troubleshooting 67–74

V

Voicemail 50
 Voice prompts 51
 Volume control
 listening volume 24
 ringer volume 13

Remote access wallet card

Use the wallet card below to help you remember commands to control your answering system from any touch-tone telephone.

Cut along dotted line.



Call your telephone number, then enter your four-digit access code (preset to **0000**).

Action	Remote command
--------	----------------

Play all messages or record announcement.....	1
Accept the recorded announcement.....	2
Delete the message or recorded announcement.....	3
Repeat the message.....	4
Help menu or end the recording.....	5
Skip the message.....	6
Transfer the message.....	7
Transfer message to other mailbox...(Mailbox number) + #	
Change the announcement.....	8
Change to the general delivery mailbox.....	9
End remote access call.....	X (or hang up)

Fold here.

Model name: SynJ SB67148

Type: SynJ SB67148 DECT 6.0 4-line expansion deskset for use with AT&T model SynJ SB67118/SB67138

© 2010 Advanced American Telephones. All Rights Reserved. AT&T and the AT&T logo are trademarks of AT&T Intellectual Property licensed to Advanced American Telephones, San Antonio, TX 78219. Printed in China. SynJ™ is a trademark of Advanced American Telephones.



Proud Sponsor

www.telephones.att.com