



at&t

Quick start guide

**EL52200/EL52210/EL52250/
EL52300/EL52350/EL52400/
EL52450/EL52500/EL52510
DECT 6.0 cordless telephone/
answering system with
caller ID/call waiting**



Introduction

This quick start guide provides you with basic installation and use instructions. A limited set of features are described in abbreviated form.

 Please refer to the complete online **EL52200/EL52210/EL52250/EL52300/EL52350/EL52400/EL52450/EL52500/EL52510 DECT 6.0 cordless telephone/answering system with caller ID/call waiting** user's manual for a full set of installation and operation instructions at **<http://telephones.att.com/EL52XX0>**.

Before using this AT&T product, please read **Important safety information** on pages 23-24 of this quick start guide.

Table of contents

Parts checklist.....	2	Answering system and voicemail.....	17
Installation.....	3	Turning the answering system on or off	17
Battery installation.....	4	Announcement	17
Battery charging.....	5	Call screening.....	18
Handset overview.....	6	Message playback.....	18
Telephone base overview.....	7	To delete all old messages	18
Menu overview.....	8	Remote access.....	18
Menu structure	8	Troubleshooting.....	19
Telephone settings	9	Important safety information	23
Making, answering and ending a call.....	10	FCC Part 68 and ACTA.....	25
Options while on a call.....	11	FCC Part 15.....	26
Handset locator.....	12	Limited warranty.....	27
Intercom.....	13	Technical specifications	29
Directory	14		
Speed dial	15		
Caller ID overview.....	16		
Caller ID history (call log).....	16		

Parts checklist

Your telephone package contains the following items. Save your sales receipt and original packaging in the event warranty service is necessary.



Quick start guide



Telephone base



Power adapter for telephone base



Cordless handset

(2 for EL52200, EL52210 or EL52250)
(3 for EL52300 or EL52350)
(4 for EL52400 or EL52450)
(5 for EL52500 or EL52510)



Charger for cordless handset with power adapter installed

(1 for EL52200, EL52210 or EL52250)
(2 for EL52300 or EL52350)
(3 for EL52400 or EL52450)
(4 for EL52500 or EL52510)

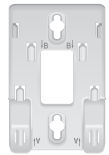

Wall mount bracket



Battery for cordless handset

(2 for EL52200, EL52210 or EL52250)
(3 for EL52300 or EL52350)
(4 for EL52400 or EL52450)
(5 for EL52500 or EL52510)



Battery compartment cover

(2 for EL52200, EL52210 or EL52250)
(3 for EL52300 or EL52350)
(4 for EL52400 or EL52450)
(5 for EL52500 or EL52510)



Telephone line cord

Installation

Install the telephone base and charger as shown below. If you subscribe to high-speed Internet service (DSL - digital subscriber line) through your telephone line, you must install a DSL filter on the DSL line. If you want to mount your telephone on a wall, use the included wall mount bracket and refer to **Wall mount installation** in the online user's manual for details.

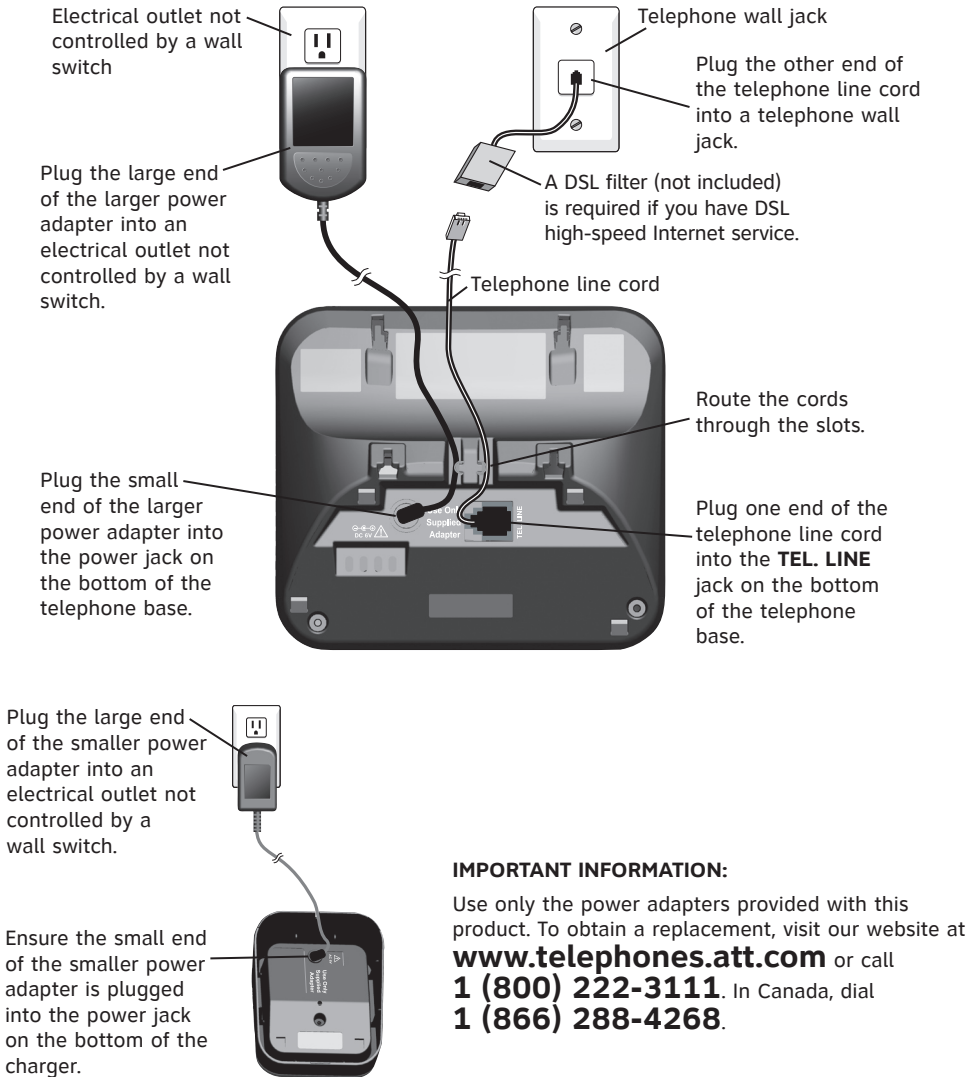

IMPORTANT INFORMATION:

Use only the power adapters provided with this product. To obtain a replacement, visit our website at www.telephones.att.com or call **1 (800) 222-3111**. In Canada, dial **1 (866) 288-4268**.

Battery installation

Install the battery as shown below.

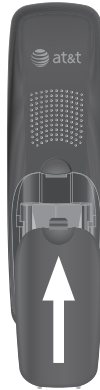
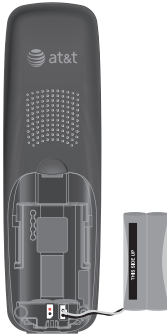

1. Plug the battery connector securely into the socket inside the handset battery compartment, matching the color-coded label.
2. Insert the supplied battery with the label **THIS SIDE UP** facing up as indicated.
3. Align the cover flat against the battery compartment, then slide it upwards until it clicks into place.



4. Charge the handset by placing it face up in the telephone base or charger. The **CHARGE** light is on when charging.



To replace the battery, press the tab and slide the battery compartment cover downwards. Lift out the old battery and disconnect it from the handset. Follow the instructions above to install and charge the new battery.

IMPORTANT INFORMATION:

Use only the supplied rechargeable battery or replacement battery (model BT166342). To order, visit our website at www.telephones.att.com, or call **1 (800) 222-3111**. In Canada, dial **1 (866) 288-4268**.



Battery charging

Once you have installed the battery, the screen indicates the battery status (see the table below). If necessary, place the handset in the telephone base or charger to charge the battery. For best performance, keep the handset in the telephone base or charger when not in use. The battery is fully charged after 10 hours of continuous charging. See page 29 for battery operating times.



Battery status icon

If the screen is blank, you need to charge the handset without interruption for at least 30 minutes to give the handset enough charge to use the telephone for a short time. The screen shows **LOW BATTERY** until you have charged the battery without interruption for at least 30 minutes. The following table summarizes the battery charge indicators and actions to take.

Battery indicators	Battery status	Action
The screen is blank or shows PLACE IN CHARGER.	The battery has no or very little charge. The handset cannot be used.	Charge without interruption until the screen shows LOW BATTERY or HANDSET X (at least 30 minutes).
The screen shows LOW BATTERY and  flashes.	Battery has enough charge to be used for a short time.	Charge without interruption until the screen shows HANDSET X (at least 30 minutes).
The screen shows HANDSET X and the battery icon shows  .	Battery is charged.	To keep the battery charged, place it in the telephone base or charger when not in use.

NOTES:

- If you are on a call in low battery mode, you hear four short beeps every 50 seconds.
- If no battery is installed in the handset when you place it in the telephone base or charger, the **CHARGE** light is off and the screen shows **NO BATTERY**. Follow the instructions in **Battery installation** on page 4 to install the battery.

Handset overview

REDIAL/PAUSE

Press repeatedly to view the last 20 numbers dialed.

While entering numbers, press and hold to insert a dialing pause.

PHONE/FLASH

Press to make or answer a call.

During a call, press to answer an incoming call when you receive a call waiting alert.

1

While reviewing a caller ID history entry, press repeatedly to add or remove 1 in front of the telephone number before dialing or saving it in the directory.

0

While entering names in the directory, press to add a space.

MUTE/DELETE

During a call, press to mute the microphone.

While predialing, press to delete digits.

While reviewing the redial list, directory, speed dial list or caller ID history, press to delete an individual entry.

TOPE*

During a call, press to send touch-tone signals.

SPEAKER

Press to turn on the handset speakerphone, press again to resume normal handset use.

INT

Press to initiate an intercom conversation or transfer a call.

▲DIR/VOLUME

Press to scroll up while in menus.

Press to increase the listening volume.

Press to show directory entries when the handset is not in use.

While entering names or numbers in the directory, press to move the cursor to the right.

▼CID/VOLUME

Press to scroll down while in menus.

Press to decrease the listening volume.

Press to show the caller ID history when the handset is not in use.

While entering names or numbers in the directory, press to move the cursor to the left.

MENU/SELECT

Press to display the menu.

Once in the menu, press to select an item or save an entry or setting.

OFF/CLEAR

During a call, press to hang up.

While using menus, press to cancel an operation, back up to the previous menu, or exit the menu display.

Press and hold while the handset is not in use to erase the missed calls indicator.

#

When reviewing a caller ID history entry, press repeatedly to view the dialing options.



Telephone base overview



ANSWER ON/OFF

Press to turn the built-in answering system on or off.

Message window

Displays the number of messages. During playback, displays the message number currently playing.

PLAY/STOP

Press to start or stop message playback. While call screening, press to temporarily turn the call screening on or off.

DELETE

Press to delete the message currently playing. Press twice to delete all old messages when the telephone is not in use.

SKIP

Press to skip a message.

REPEAT

After the answering system plays the day and time the current message was received, press to repeat the message currently playing.

While the answering system is playing the day and time the current message was received, press to listen to the previous message.

HANDSET LOCATOR

Press to make handsets beep so you can locate them.

VOLUME

While the telephone is not in use, press to adjust the telephone base ringer volume. During call screening or message playback, press to adjust the listening volume.

Menu overview

Use the menu to change the telephone settings.

1. Press **MENU/SELECT** in idle mode (when the handset is not in use) to enter the main menu.
2. Press **▲DIR** or **▼CID** to scroll until the **>** is next to the feature you want to select.
3. Press **MENU/SELECT** to select or save the indicated item.

Press **↶OFF/CLEAR** to cancel an operation, back up to the previous menu or exit the menu display. Press and hold **↶OFF/CLEAR** to cancel an operation and return to idle mode.



The handset is in idle mode.

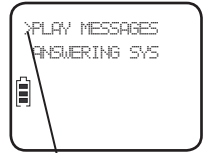

The **>** symbol indicates the feature to select.

Menu structure

Many of the telephone settings are common to all handsets and the base, such as the date and time. Some settings are specific to each handset, such as the ring tone and volume settings. Refer to **Menu overview** in the online user's manual for details.

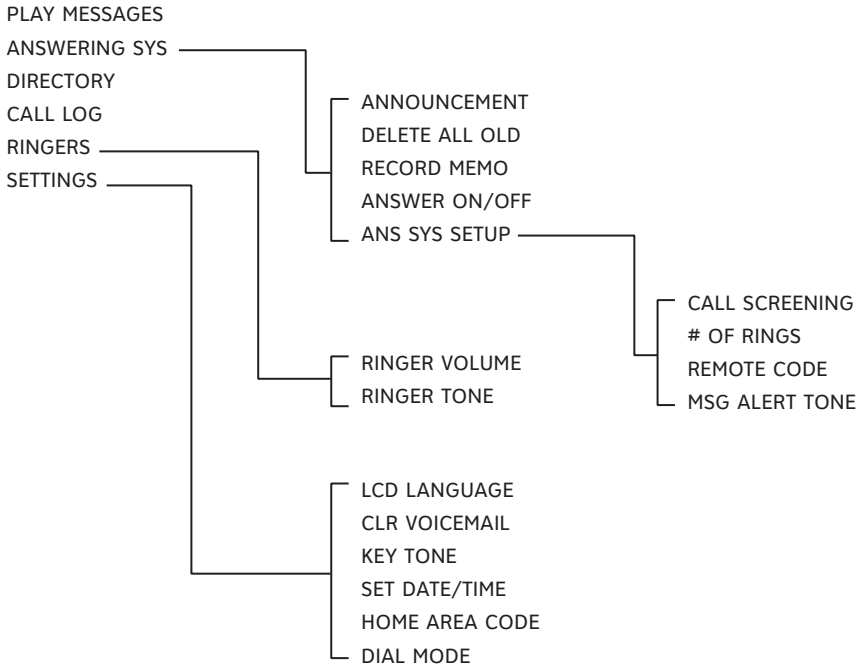

Telephone settings

Use **Menu structure** on page 8 to find and set features. Many are simple yes/no questions. The following are a few examples of common features to set. Refer to **Handset settings** and **Answering system settings** in the online user's manual for detailed instructions on setting all telephone features.

Ringer volume

Set the ringer volumes individually on each handset and the telephone base.

Handset:

You can set the handset ringer volume level, or turn the ringer off. When the ringer is off,  appears on the handset screen.

1. On a handset, press **MENU/SELECT** in idle mode. Select **>RINGERS** and then select **>RINGER VOLUME**.
2. Press **▲DIR** or **▼CID** to sample each volume level.
3. Press **MENU/SELECT** to save your preference.



 **NOTE:** If the handset ringer volume is set to off, that handset ringer is silenced for all incoming calls; however, that handset still plays the paging tone when you use the handset locator feature.

Telephone base:

When the telephone is not in use, press **▲▼VOLUME** on the telephone base to adjust the ringer volume.



Date and time

The answering system announces the day of the week and time of each message received prior to playing it. If you subscribe to caller ID service, the day, month and time are set automatically with each incoming call. However, the year must be set so that the day of the week can be calculated from the caller ID information.

1. On a handset, use **MENU/SELECT** in idle mode. Select **>SETTINGS** and then select **>SET DATE/TIME**.
2. Use the dial pad keys (0-9) to enter two-digit numbers for the month, day and year. Press **MENU/SELECT**.
3. Use the dial pad keys (0-9) to enter two-digit numbers for the hour and minute.
4. Press **▲DIR** or **▼CID** to choose **AM** or **PM**. Press **MENU/SELECT** to confirm.

Making, answering and ending a call

Making a call

Press **PHONE/FLASH** or **SPEAKER** and then dial a telephone number, or predial by first dialing the number and then pressing **PHONE/FLASH** or **SPEAKER**. When entering the number before pressing **PHONE/FLASH** or **SPEAKER**, you can:

- Press and hold **REDIAL/PAUSE** to insert a three-second dialing pause (a **P** appears).
- Press **MUTE/DELETE** to make corrections.
- Press and hold **OFF/CLEAR** to return to the idle mode.

The screen shows the elapsed time as you talk (in hours, minutes and seconds).

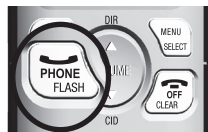

Answering a call

Press **PHONE/FLASH**, **SPEAKER**, or any dial pad key (known as Any Key Answer).

Ending a call

Press **OFF/CLEAR** or put the handset in the telephone base or charger to end the call (known as Auto Off).

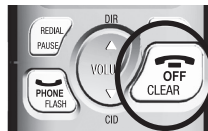

Speakerphone

During a call, press **SPEAKER** to switch between speakerphone and normal handset use.

Press **OFF/CLEAR** to hang up.

Temporary ringer silencing

While the telephone is ringing, press **OFF/CLEAR** or **MUTE/DELETE** to silence the ringer temporarily on that handset only. This turns off the ringer without disconnecting the call. The next incoming call rings normally at the preset volume.

Options while on a call

Volume control

While on a call, press **▲DIR/VOLUME** to increase or press **▼CID/VOLUME** to decrease the listening volume.

NOTE: The handset earpiece volume setting (1-5) and speakerphone volume setting (1-6) are independent. Changing one does not affect the other.



Join a call in process

You can use two system handsets at the same time on an outside call. If a handset is already on a call and you would like to join the call, press **PHONE/FLASH** or **SPEAKER** on another system handset.

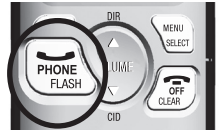

To exit the call, press **OFF/CLEAR** or place the handset in the telephone base or charger. The call does not end until all handsets hang up.

Chain dialing

While on a call, you can initiate a dialing sequence from numbers stored in the directory, caller ID history or redial list. Doing this can be useful if you wish to access other numbers (such as bank account numbers or access codes).

To dial a number from the directory, caller ID history or redial list while on a call, access the number through the menu system:

1. While on a call, to show the directory or caller ID history, press **MENU/SELECT**, scroll to **>DIRECTORY** or **>CALL LOG**. Press **MENU/SELECT**.

-OR-

While on a call, press **REDIAL/PAUSE** to show the redial list.

2. Scroll to the desired number or press the dial pad keys to find the desired directory entry (see **To search by name** in the online user's manual for more options).
3. Press **MENU/SELECT**. The selected number is dialed.

Redial

Each handset stores the 20 most recently called numbers in the redial list.

1. To review and call numbers in the redial list, press **REDIAL/PAUSE** in idle mode. The most recently called number appears on the screen.
2. If it is not the desired number, press **▲DIR** or **▼CID** to scroll through the numbers in the list.
3. Once the desired number appears, press **PHONE/FLASH** or **SPEAKER** to dial the number. Or press **OFF/CLEAR** to exit the redial list.



Handset locator

Use the handset locator to find misplaced handsets.

To start the paging tone:

- Press  **HANDSET LOCATOR** at the telephone base to start the paging tone on all handsets for 60 seconds.

To stop the paging tone:

- Press  **PHONE/FLASH**,  **SPEAKER**, or any dial pad key (0-9, *, or #) on a handset or press  **HANDSET LOCATOR** on the telephone base.

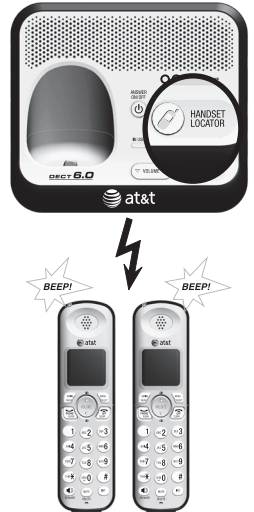

To make and answer an intercom call

You can intercom between handsets.

1. Press **INT** on your handset when not in use.
 - If you have two handsets, your screen shows **CALLING HANDSET X**.
 - If you have more than two handsets, your screen shows **INTERCOM TO:** Use the dial pad keys to select the other handset.
 - The other handset rings and its screen shows **HANDSET X IS CALLING**.
2. To answer the intercom call, press **PHONE/FLASH**, **SPEAKER** or **INT** on that handset. Both handsets now show **INTERCOM**.
3. To end an intercom call, press **OFF/CLEAR** or place the handset back in the telephone base or charger.

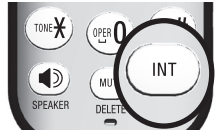

NOTE: Before the intercom call is answered, you can cancel the intercom call by pressing **OFF/CLEAR** or **INT** on your originating handset.

Call transfer using intercom

You can transfer an outside call to another system handset.

During a call, press **INT** and proceed just as you would for a normal intercom call. Once the other party has answered the intercom, you have the following options:

- You can let the other handset join you on the outside call in a three-way conversation. Press and hold **INT** on the calling handset.
- You can transfer the call. Press **OFF/CLEAR**, or place your handset back in the telephone base or charger. Your handset screen shows **CALL TRANSFERRED**. The other handset automatically connects to the outside call.
- You can switch between the outside call (**OUTSIDE CALL** appears on the screen) and the intercom call (**INTERCOM** appears on the screen). Press **INT** on your handset to switch.
- The other person can end the intercom call by pressing **OFF/CLEAR**, or by placing the other handset back in the telephone base or charger. The outside call continues with the original system handset.

NOTES:

- To cancel the transfer and return to the external call before the intercom call is answered, press **OFF/CLEAR**, **PHONE/FLASH** or **INT** on your handset.
- If the other handset is not answered within 100 seconds, is in use, on a call or is out of range, the calling handset shows **UNABLE TO CALL TRY AGAIN** on its screen and automatically returns to the external call.

Directory

Directory overview

The directory is stored in the telephone base, and is shared by all handsets. It stores up to 100 entries. Changes made to the directory on any one handset apply to all. Only one handset can review the directory at a time.

Storing names and numbers

You can add new entries to the directory whenever a telephone number shows on the screen (predial or from caller ID history) by pressing **MENU/SELECT** then go to Step 3 below. To add entries through the menu:

1. On a handset, use **MENU/SELECT** in idle mode. Select **>DIRECTORY** and then select **>ADD CONTACT**.
2. Use the dial pad keys or press **REDIAL/PAUSE** and then **MENU/SELECT** to enter the telephone number (up to 30 digits).
3. Press **MENU/SELECT** to save the number in the display.
4. Enter the name when prompted. Use the dial pad keys to enter a name (up to 15 characters). Each time you press a key, the character on that key appears. Additional key presses produce other characters on that key. Refer to the character chart in **Create directory entries** of the online user's manual for information on entering special characters.
5. Press **MENU/SELECT** to store your new directory entry. The screen shows **SAVED**.

While entering names and numbers, you can edit them using the following controls:

- Press **▲DIR** or **▼CID** to move the cursor to the right or left.
- Press **MUTE/DELETE** to erase digits or characters.
- Press and hold **MUTE/DELETE** to erase entire entry.
- While entering the telephone number, press and hold **REDIAL/PAUSE** to enter a three-second dialing pause (a **P** appears).
- While entering the name, press **0** to add a space.

To review directory entries

1. Press **▲DIR** when in idle mode to show the first entry in the directory.
2. Press **▲DIR** or **▼CID** to browse through the directory or press the dial pad keys (0-9) to start a name search. Entries appear alphabetically by the first letter in the name.

 **NOTE:** If the telephone number in the directory exceeds 15 digits, **<*** appears in front of the telephone number. Press **TONEx** to move towards the end of the telephone number or press **#** to move towards the beginning of the telephone number.

To dial a directory number

When you see the desired directory number, press **PHONE/FLASH** or **SPEAKER**.

To edit a directory entry

1. When the desired directory number is on the screen, press **MENU/SELECT**.
2. Edit the telephone number (page 14). Press **MENU/SELECT**.
3. Edit the name (page 14).
4. Press **MENU/SELECT** to confirm.

To delete a directory entry

When the desired directory number is on the screen, press **MUTE/DELETE** and then **MENU/SELECT**.

Speed dial

There are 10 speed dial locations that you assign from the directory (see **Speed dial locations** in the online user's manual for details). The speed dial locations are shared by all handsets. Changes made apply to all handsets.

To enter a speed dial number

1. On a handset, use **MENU/SELECT** in idle mode. Select **>DIRECTORY** and then select **>SPEED DIAL**.
2. Press **▲DIR** or **▼CID** to scroll to the desired speed dial location.
3. Press **MENU/SELECT** to show the directory. Press **▲DIR** or **▼CID** to browse through the directory or press the dial pad keys (0-9) to start a name search.
4. When the screen shows the desired directory entry, press **MENU/SELECT**.

To dial a speed dial number

1. When in idle mode, press and hold a dial pad key (0 through 9) to display the desired speed dial entry.
2. Press **PHONE/FLASH** or **SPEAKER** to dial the displayed telephone number.

Caller ID overview

This product supports caller ID services offered by most telephone service providers. Caller ID allows you to see the name, number, date and time of calls. The available caller ID information will appear after the first or second ring.

Caller ID history (call log)

The caller ID information is stored in a 50-entry caller ID history. Until unanswered new calls are reviewed in the caller ID history, they are reported as **XX MISSED CALLS** on the handset idle screen. If you want to mark all of the messages OLD, press and hold **OFF/CLEAR** for four seconds when the handset is idle.

To review the caller ID history

1. When a handset is in idle mode, press **▼CID**.
2. Press **▲DIR** or **▼CID** scroll through the list.
3. Press **OFF/CLEAR** exit the caller ID history.

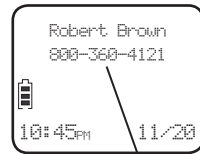

To dial a number from the caller ID history

1. When a handset is in idle mode, press **▼CID**.
2. Press **▲DIR** or **▼CID** scroll through the list.
 - Press **#** repeatedly to show different dialing options.
 - If you need to add or remove a **1** at the beginning of the number, press **1** repeatedly to show the number options.
3. Press **PHONE/FLASH** or **SPEAKER** to dial the displayed telephone number.

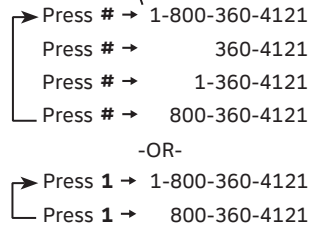

To delete entries from the caller ID history

- **Delete One:** When viewing an entry, press **MUTE/DELETE** to delete the entry from the caller ID history.
- **Delete all:** On a handset, use **MENU/SELECT** in idle mode. Select **>CALL LOG** and then select **>DEL ALL CALLS**. Press **MENU/SELECT** twice.

Once deleted, you cannot retrieve the entries.

To store a caller ID entry in the Directory

1. On a handset, press **▼CID** in idle mode.
2. Press **▲DIR** or **▼CID** to scroll through the list.
3. When the desired entry is on the screen, press **MENU/SELECT**. The screen shows **EDIT NUMBER**. If needed, modify the number (page 14).
4. Press **MENU/SELECT** to save the number in the display. The screen shows **EDIT NAME**. If needed, modify the name (page 14).
5. Press **MENU/SELECT** to confirm.

Answering system and voicemail

Your telephone has separate indicators for two different types of voice messages: those left on its built-in answering system and those left at your service provider's voicemail (fees may apply). Your telephone's built-in answering system messages and voicemail messages are separate. Each alerts you to new messages differently.

- If  and **NEW VOICEMAIL** display on the handset, your telephone service provider is indicating that it has new voicemail for you. To listen to your voicemail, you typically dial an access number provided by your telephone service provider, followed by a security code or PIN. Refer to **Voicemail waiting (visual message waiting) indicator** in the online user's manual for a full description of the voicemail indicator.
- If a number flashes in the message window on the telephone base and **XX NEW MESSAGES** appears on the screen of each system handset, there are new digital answering system messages. If you turn on **MSG ALERT TONE** (page 8), the telephone base beeps every 10 seconds when there are new answering system messages. To listen to these messages, from a handset, use the **PLAY MESSAGES** menu or press **▶/■ PLAY/STOP** on the telephone base (see **Message playback** on page 18).

Some service providers bundle or combine multiple services like voicemail and call waiting, so you may not be aware that you have voicemail. To check what services you have and how to access them, contact your telephone service provider.

You can use your telephone answering system and voicemail together by setting your built-in answering system to answer before voicemail answers. Refer to **Answering system and voicemail** in the online user's manual for instructions.

Turning the answering system on or off

You can turn the answering system on or off by pressing the **ANSWER ON/OFF** key on the telephone base or through the **ANSWER ON/OFF** handset menu (page 8).

 **NOTE:** You can turn the answering system on or off from either the handset or the telephone base, but you can only use the handset to change the other answering system settings.

Announcement

The announcement is the greeting callers hear when calls are answered by the answering system. The telephone has a default announcement. You can use this announcement, or record your own announcement of up to 90 seconds.

On a handset, use **MENU/SELECT** in idle mode. Select **>ANSWERING SYS** and then select **>ANNOUNCEMENT**. Follow the screen and voice prompts to record a new announcement.



Call screening

If **CALL SCREENING** is **ON** (page 8), the incoming messages are played through the speaker on the telephone base. You can press **PHONE/FLASH** or **SPEAKER** on the handset to stop recording and speak to the caller.

Message playback

If there are new messages, the system plays back only the new messages (oldest first). If there are no new messages, the system plays back all old messages (oldest first). When playback begins, the total number of messages is announced.

You can play back messages from either the telephone base or a handset.

On the telephone base, press **PLAY/STOP** and use the other keys to repeat, skip, delete, and adjust the volume of messages.

On a handset, use **MENU/SELECT** to select **>PLAY MESSAGES**. Then follow the screen and voice prompts.

To delete all old messages

From idle you can delete all old messages. Once deleted, you cannot retrieve them. You cannot delete messages until you have listened to them.

On the telephone base, press **X DELETE** twice.

On a handset, use **MENU/SELECT** in idle mode. Select **>ANSWERING SYS** and then select **>DELETE ALL OLD**. Press **MENU/SELECT**.

Remote access

You can access the answering system remotely by dialing your home telephone number from any touch-tone telephone. When the answering system answers, enter the two-digit remote access code (19, unless you have changed it; refer to **REMOTE CODE** on page 8). New messages play automatically. Use the remote commands to control playback. There is also a wallet card listing the remote commands at the back of the online user's manual.

Remote access commands

Action	Remote command	Action	Remote command
Play all messages	1	Stop.....	5
Play new messages.....	2	Help menu	*5
Delete the message (during playback).....	3	Skip the message.....	6
Delete all old messages	33	Record announcement	*7
Repeat or go back	4	Turn system on or off	0
		End remote access call (or hang up).....	8

Troubleshooting

If you have difficulty with your telephone, please try the suggestions below. For customer service, or to purchase accessories or replacement parts, visit our website at **www.telephones.att.com**, or call **1 (800) 222-3111**. In Canada, dial **1 (866) 288-4268**. When you call customer service, you will need the serial number or model number found on the bottom of the telephone base.

My telephone doesn't work at all.

- Make sure the power cord is securely plugged in.
- Make sure that the battery connector is securely plugged into the cordless handset.
- Make sure the telephone line cord is securely and firmly plugged into the telephone base and the telephone wall jack.
- Charge the battery in the cordless handset for at least 10 hours. For optimum daily performance, return the cordless handset to the telephone base or charger when not in use.
- If the battery is depleted, it may take approximately 30 minutes to charge the handset before it shows **LOW BATTERY**, refer to **Battery charging** on page 5 for details.
- Reset the telephone base. Unplug the electrical power. Wait for approximately 15 seconds, then plug it back in. Allow up to one minute for the cordless handset and telephone base to reset.
- You may need to purchase a new battery. Please refer to **Battery installation** on page 4.

I cannot get a dial tone.

- First try all the suggestions above.
- Move the cordless handset closer to the telephone base. You might have moved out of range.
- If the previous suggestions don't work, disconnect the telephone base from the telephone wall jack and connect to a different telephone. If there is no dial tone on that telephone either, the problem is in your wiring or telephone service. Contact your telephone service provider (charges may apply).
- Your telephone line cord might be defective. Try installing a new telephone line cord.

I cannot dial out.

- First try all the suggestions in the item **I cannot get a dial tone** on this page.
- Make sure you have a dial tone before dialing. The cordless handset may take a second or two to find the telephone base and produce a dial tone. This is normal. Wait an extra second before dialing.
- Check that all the telephones connected to the same telephone line are hung up.
- Make sure to set the dial mode to the correct setting (pulse dialing or tone dialing) for the service in your area (see the **DIAL MODE** menu on page 8).

- Eliminate any background noise. Noise from a television, radio or other appliances may cause the telephone to not dial out properly. If you cannot eliminate the background noise, first try muting the cordless handset before dialing, or dialing from another room in your home with less background noise.
- If the other telephones in your home are having the same problem, the problem is in your wiring or telephone service. Contact your telephone service provider (charges may apply).

My cordless handset isn't performing normally.

- Make sure the power cord is securely plugged into the telephone base. Plug the power adapter into a different, working electrical outlet not controlled by a wall switch.
- Move the cordless handset closer to the telephone base. You might have moved out of range.
- Reset the telephone base. Unplug the electrical power. Wait for 15 seconds then plug it back in. Allow up to one minute for the cordless handset and telephone base to reset.
- Other electronic products can cause interference to your cordless telephone. Try installing your telephone as far away from these types of electronic devices as possible: television sets, VCRs, or other cordless telephones.

OUT OF RANGE OR NO PWR AT BASE appears on my cordless handset.

- Ensure that the telephone base is powered up.
- Place the cordless handset in the telephone base for one minute to allow the cordless handset and base to synchronize.
- Move the cordless handset closer to the telephone base. You might have moved out of range.
- Reset the telephone base. Unplug the electrical power. Wait for 15 seconds then plug it back in. Allow up to one minute for the cordless handset and telephone base to reset.
- Other electronic products can cause interference to your cordless telephone. Try installing your telephone as far away from these types of electronic devices as possible: television sets, VCRs, or other cordless telephones.

The batteries do not hold a charge.

- If the cordless handset is in the telephone base or charger and the charge light does not come on, refer to the item **The charge light is off** on page 21.
- Charge the battery in the cordless handset for at least 10 hours. For optimum daily performance, return the cordless handset to the telephone base or charger when not in use.
- If the battery is depleted, it may take approximately 30 minutes to charge the handset before it shows **LOW BATTERY**, refer to **Battery charging** on page 5 for details.
- You may need to purchase a new battery. Please refer to **Battery installation** on page 4.

The charge light is off.

- Make sure the power cord is plugged in correctly and securely.
- Make sure the battery is installed correctly in the handset. Follow the instructions in **Battery installation** on page 4 to install the battery.
- Unplug the electrical power. Wait for 15 seconds, then plug it back in. Allow up to one minute for the cordless handset and telephone base to reset.
- Clean the cordless handset and telephone base charging contacts each month using a pencil eraser or cloth.

I get noise, static, or weak signals even when I'm near the telephone base.

- If you subscribe to high-speed Internet service (DSL - digital subscriber line) through your telephone line, you must install a DSL filter between the telephone line cord and the telephone wall jack (see **Installation** on page 3). The filter prevents noise and caller ID problems caused by DSL interference. Please contact your DSL service provider for more information about DSL filters.
- Other electronic products, such as computers, wireless routers, microwave ovens and other cordless telephones can interfere with the performance of your cordless telephone. You may be able to improve the performance of your telephone by installing the telephone base as far away as possible from other electronic devices.
- Do not install this telephone near a microwave oven or on the same electrical outlet. You may experience decreased performance while the microwave oven is operating.
- If your telephone is plugged in with a modem or a surge protector, plug the telephone (or modem/surge protector) into a different location. If this doesn't solve the problem, relocate your telephone or modem farther apart from one another, or use a different surge protector.
- Relocate your telephone to a higher location. The telephone will likely have better reception when installed in a high area.
- If the other telephones in your home are having the same problem, the problem is in your wiring or telephone service. Contact your telephone service provider (charges may apply).

I experience poor sound quality when using the speakerphone.

- For increased sound quality while using the speakerphone, place the handset on a flat surface with the dial pad facing up.
- When using a speakerphone, controlling background noise in your environment is essential. While you are listening to your party, press **MUTE/DELETE** to temporarily turn your microphone off. When it is your turn to speak, remember to press **MUTE/DELETE** again to turn the microphone on.
- Excessive background noise will cause a speakerphone to fade in and out. Try controlling the background noise by turning off any audio devices near the speakerphone. Also, try to avoid interrupting the person at the other end of the conversation while they are speaking. If background noise cannot be controlled, you should terminate speakerphone operation and return to normal handset mode.

I hear other calls while using my telephone.

- Disconnect the telephone base from the telephone wall jack, and plug in a different telephone. If you still hear other calls, the problem is probably in your wiring or telephone service. Call your telephone service provider (charges may apply).

I subscribe to a nontraditional telephone service that uses my computer to establish connections, and my telephone doesn't work.

- Make sure your computer is powered on.
- Make sure your Internet connection is working properly.
- Make sure that the software is installed and running for your nontraditional telephone service.
- Make sure to plug your USB telephone adapter into a dedicated USB port on your computer. Do not plug into a multiple port USB hub (USB splitter) that is not powered.
- In a few rare instances, the USB port on your computer may not have enough power. In these instances, try using a USB hub with its own external power supply.
- If you are using a firewall, it may prevent access to your nontraditional telephone service. Contact your service provider for more information.

Important safety information

 This symbol is to alert you to important operating or servicing instructions that may appear in this quick start guide and the online user's manual. Always follow basic safety precautions when using this product to reduce the risk of injury, fire, or electric shock.

Safety information

- **Read and understand all instructions in this quick start guide and the online user's manual. Observe all markings on the product.**
- **Avoid using a telephone during a thunderstorm.** There might be a slight chance of electric shock from lightning.
- **Do not use a telephone in the vicinity of a gas leak.** Under certain circumstances, a spark may be created when the adapter is plugged into the power outlet, or when the handset is replaced in its cradle. This is a common event associated with the closing of any electrical circuit. The user should not plug the phone into a power outlet, and should not put a charged handset into the cradle, if the phone is located in an environment containing concentrations of flammable or flame-supporting gases, unless there is adequate ventilation. A spark in such an environment could create a fire or explosion. Such environments might include: medical use of oxygen without adequate ventilation; industrial gases (cleaning solvents; gasoline vapors; etc.); a leak of natural gas; etc.
- **Do not use this product near water, or when you are wet.** For example, do not use it in a wet basement or shower, or next to a swimming pool, bathtub, kitchen sink, or laundry tub. Do not use liquids or aerosol sprays for cleaning. If the product comes in contact with any liquids, unplug any line or power cord immediately. Do not plug the product back in until it has dried thoroughly.
- **Install this product in a protected location** where no one can trip over any line or power cords. Protect cords from damage or abrasion.
- **If this product does not operate normally, read the Troubleshooting section starting on page 19 in this quick start guide.** If you cannot solve the problem, or if the product is damaged, refer to the **Limited warranty** section starting on page 27. Do not open this product except as may be directed in this quick start guide and the online user's manual. Opening the product or reassembling it incorrectly may expose you to hazardous voltages or other risks.
- **Replace batteries only as described in Battery installation on page 4 in this quick start guide.** Do not burn or puncture batteries — they contain caustic chemicals.
- **The power adapters are intended to be correctly oriented in a vertical or floor mount position.** The prongs are not designed to hold the plug in place if they are plugged into a ceiling, under-the-table or cabinet outlet.

 **CAUTION:** Use only the power adapters provided with this product. To obtain a replacement, visit our website at **www.telephones.att.com**, or call **1 (800) 222-3111**. In Canada, dial **1 (866) 288-4268**.

Especially about cordless telephones

- **Privacy:** The same features that make a cordless telephone convenient create some limitations. Telephone calls are transmitted between the telephone base and the handset by radio waves, so there is a possibility that your cordless telephone conversations could be intercepted by radio receiving equipment within range of the cordless handset. **For this reason, you should not think of cordless telephone conversations as being as private as those on corded telephones.**

- **Electrical power:** The telephone base of this cordless telephone must be connected to a working electrical outlet which is not controlled by a wall switch. **Calls cannot be made from the handset if the telephone base is unplugged, switched off or if the electrical power is interrupted.**
- **Potential TV interference:** Some cordless telephones operate at frequencies that may cause interference to TVs and VCRs. To minimize or prevent such interference, do not place the telephone base of the cordless telephone near or on top of a TV or VCR. If interference is experienced, moving the cordless telephone farther away from the TV or VCR will often reduce or eliminate the interference.
- **Rechargeable batteries:** This product contains nickel-metal hydride rechargeable batteries. Exercise care in handling batteries in order not to create a short circuit with conductive material such as rings, bracelets, and keys. The battery or conductor may overheat and cause harm. Observe proper polarity between the battery and the battery charger.
- **Nickel-metal hydride rechargeable batteries:** Dispose of these batteries in a safe manner. Do not burn or puncture. Like other batteries of this type, if burned or punctured, they could release caustic material which could cause injury.



The RBRC™ Seal means that the manufacturer is voluntarily participating in an industry program to collect and recycle nickel-metal hydride rechargeable batteries when taken out of service within the United States. These batteries may be taken to a participating local retailer of replacement batteries or recycling center. Or you may call 1 (800) 8-BATTERY for locations accepting spent Ni-MH batteries.

Precautions for users of implanted cardiac pacemakers

Cardiac pacemakers (applies only to digital cordless telephones): Wireless Technology Research, LLC (WTR), an independent research entity, led a multidisciplinary evaluation of the interference between portable wireless telephones and implanted cardiac pacemakers. Supported by the U.S. Food and Drug Administration, WTR recommends to physicians that:

Pacemaker patients

- Should keep wireless telephones at least six inches from the pacemaker.
- Should NOT place wireless telephones directly over the pacemaker, such as in a breast pocket, when it is turned ON.
- Should use the wireless telephone at the ear opposite the pacemaker.

WTR's evaluation did not identify any risk to bystanders with pacemakers from other persons using wireless telephones.

Especially about telephone answering systems

Two-way recording: This unit does not sound warning beeps to inform the other party that the call is being recorded. To ensure that you are in compliance with any federal or state regulations regarding recording a telephone call, you should start the recording process and then inform the other party that you are recording the conversation.

SAVE THESE INSTRUCTIONS

FCC Part 68 and ACTA

This equipment complies with Part 68 of the FCC rules and with technical requirements adopted by the Administrative Council for Terminal Attachments (ACTA). The label on the back or bottom of this equipment contains, among other things, a product identifier in the format US:AAAEQ##TXXXX. This identifier must be provided to your telephone service provider upon request.

The plug and jack used to connect this equipment to premises wiring and the telephone network must comply with the applicable Part 68 rules and technical requirements adopted by ACTA. A compliant telephone cord and modular plug is provided with this product. It is designed to be connected to a compatible modular jack that is also compliant. An RJ11 jack should normally be used for connecting to a single line and an RJ14 jack for two lines. See Installation Instructions in the online user's manual.

The Ringer Equivalence Number (REN) is used to determine how many devices you may connect to your telephone line and still have them ring when you are called. The REN for this product is encoded as the 6th and 7th characters following the US: in the product identifier (e.g., if ## is 03, the REN is 0.3). In most, but not all areas, the sum of all RENs should be five (5.0) or less. For more information, please contact your telephone service provider.

This equipment may not be used with Party Lines. If you have specially wired alarm dialing equipment connected to your telephone line, ensure the connection of this equipment does not disable your alarm equipment. If you have questions about what will disable the alarm equipment, consult your telephone service provider or a qualified installer.

If this equipment is malfunctioning, it must be unplugged from the modular jack until the problem has been corrected. Repairs to this telephone equipment can only be made by the manufacturer or its authorized agents. For repair procedures, follow the instructions outlined under the Limited Warranty.

If this equipment is causing harm to the telephone network, the telephone service provider may temporarily discontinue your telephone service. The telephone service provider is required to notify you before interrupting service. If advance notice is not practical, you will be notified as soon as possible. You will be given the opportunity to correct the problem and the telephone service provider is required to inform you of your right to file a complaint with the FCC. Your telephone service provider may make changes in its facilities, equipment, operation, or procedures that could affect the proper functioning of this product. The telephone service provider is required to notify you if such changes are planned.

If this product is equipped with a corded or cordless handset, it is hearing aid compatible.

If this product has memory dialing locations, you may choose to store emergency telephone numbers (e.g., police, fire, medical) in these locations. If you do store or test emergency numbers, please:

- Remain on the line and briefly explain the reason for the call before hanging up.
- Perform such activities in off-peak hours, such as early morning or late evening.

Industry Canada

Operation is subject to the following two conditions: (1) this device may not cause harmful interference, and (2) this device must accept any interference, including interference that may cause undesired operation.

The term "IC:" before the certification/registration number only signifies that the Industry Canada technical specifications were met.

The Ringer Equivalence Number (REN) for this terminal equipment is 0.1B. The REN is an indication of the maximum number of devices allowed to be connected to a telephone interface. The termination on an interface may consist of any combination of devices subject only to the requirement that the sum of the RENs of all the devices does not exceed five.

This product meets the applicable Industry Canada technical specifications.

FCC Part 15

This equipment has been tested and found to comply with the requirements for a Class B digital device under Part 15 of the Federal Communications Commission (FCC) rules.

These requirements are intended to provide reasonable protection against harmful interference in a residential installation. This equipment generates, uses and can radiate radio frequency energy and, if not installed and used in accordance with the instructions, may cause harmful interference to radio communications. However, there is no guarantee that interference will not occur in a particular installation.

If this equipment does cause harmful interference to radio or television reception, which can be determined by turning the equipment off and on, the user is encouraged to try to correct the interference by one or more of the following measures:

- Reorient or relocate the receiving antenna.
- Increase the separation between the equipment and receiver.
- Connect the equipment into an outlet on a circuit different from that to which the receiver is connected.
- Consult the dealer or an experienced radio/TV technician for help.

Changes or modifications to this equipment not expressly approved by the party responsible for compliance could void the user's authority to operate the equipment.

This device complies with Part 15 of the FCC rules. Operation is subject to the following two conditions: (1) this device may not cause harmful interference, and (2) this device must accept any interference received, including interference that may cause undesired operation. Privacy of communications may not be ensured when using this telephone.

To ensure safety of users, the FCC has established criteria for the amount of radio frequency energy that can be safely absorbed by a user or bystander according to the intended usage of the product. This product has been tested and found to comply with the FCC criteria. The handset may be safely held against the ear of the user. The telephone base shall be installed and used such that parts of the user's body other than the hands are maintained at a distance of approximately 20cm (8 inches) or more.

This Class B digital apparatus complies with Canadian ICES-003.

Limited warranty

The AT&T brand is used under license - any repair, replacement or warranty service, and all questions about this product should be directed to our website at

www.telephones.att.com or call **1 (800) 222-3111**. In Canada, dial **1 (866) 288-4268**.

1. What does this limited warranty cover?

The manufacturer of this AT&T branded product warrants to the holder of a valid proof of purchase ("CONSUMER" or "you") that the product and all accessories provided in the sales package ("PRODUCT") are free from defects in material and workmanship, pursuant to the following terms and conditions, when installed and used normally and in accordance with the PRODUCT operating instructions. This limited warranty extends only to the CONSUMER for products purchased and used in the United States of America and Canada.

2. What will be done if the PRODUCT is not free from defects in materials and workmanship during the limited warranty period ("materially defective PRODUCT")?

During the limited warranty period, the manufacturer's authorized service representative repairs or replaces at the manufacturer's option, without charge, a materially defective PRODUCT. If the manufacturer repairs the PRODUCT, they may use new or refurbished replacement parts. If the manufacturer chooses to replace the PRODUCT, they may replace it with a new or refurbished PRODUCT of the same or similar design. The manufacturer retains the defective parts, modules, or equipment. Repair or replacement of the PRODUCT, at the manufacturer's option, is your exclusive remedy. The manufacturer returns the repaired or replacement products to you in working condition. You should expect the repair or replacement to take approximately 30 days.

3. How long is the limited warranty period?

The limited warranty period for the PRODUCT extends for ONE (1) YEAR from the date of purchase. If the manufacturer repairs or replaces a materially defective PRODUCT under the terms of this limited warranty, this limited warranty also applies to repaired or replacement PRODUCT for a period of either (a) 90 days from the date the repaired or replacement PRODUCT is shipped to you or (b) the time remaining on the original one-year limited warranty; whichever is longer.

4. What is not covered by this limited warranty?

This limited warranty does not cover:

- PRODUCT that has been subjected to misuse, accident, shipping or other physical damage, improper installation, abnormal operation or handling, neglect, inundation, fire, water, or other liquid intrusion; or
- PRODUCT that has been damaged due to repair, alteration, or modification by anyone other than an authorized service representative of the manufacturer; or
- PRODUCT to the extent that the problem experienced is caused by signal conditions, network reliability or cable or antenna systems; or
- PRODUCT to the extent that the problem is caused by use with non-AT&T accessories; or
- PRODUCT whose warranty/quality stickers, PRODUCT serial number plates or electronic serial numbers have been removed, altered or rendered illegible; or
- PRODUCT purchased, used, serviced, or shipped for repair from outside the United States of America or Canada, or used for commercial or institutional purposes (including but not limited to products used for rental purposes); or

- PRODUCT returned without a valid proof of purchase (see item 6 below); or
- Charges for installation or setup, adjustment of customer controls, and installation or repair of systems outside the unit.

5. How do you get warranty service?

To obtain warranty service in the United States of America, visit

www.telephones.att.com or call **1 (800) 222-3111**. In Canada, dial

1 (866) 288-4268. NOTE: Before calling for service, please review the online user's manual. A check of the PRODUCT's controls and features might save you a service call.

Except as provided by applicable law, you assume the risk of loss or damage during transit and transportation and are responsible for delivery or handling charges incurred in the transport of the PRODUCT(s) to the service location. The manufacturer will return repaired or replaced PRODUCT under this limited warranty. Transportation, delivery or handling charges are prepaid. The manufacturer assumes no risk for damage or loss of the PRODUCT in transit. If the PRODUCT failure is not covered by this limited warranty, or proof of purchase does not meet the terms of this limited warranty, the manufacturer notifies you and requests that you authorize the cost of repair prior to any further repair activity. You must pay for the cost of repair and return shipping costs for the repair of products that are not covered by this limited warranty.

6. What must you return with the PRODUCT to get warranty service?

You must:

- a. Return the entire original package and contents including the PRODUCT to the service location along with a description of the malfunction or difficulty; and
- b. Include a "valid proof of purchase" (sales receipt) identifying the PRODUCT purchased (PRODUCT model) and the date of purchase or receipt; and
- c. Provide your name, complete and correct mailing address, and telephone number.

7. Other limitations

This warranty is the complete and exclusive agreement between you and the manufacturer of this AT&T branded PRODUCT. It supersedes all other written or oral communications related to this PRODUCT. The manufacturer provides no other warranties for this PRODUCT. The warranty exclusively describes all of the manufacturer's responsibilities regarding the PRODUCT. There are no other express warranties. No one is authorized to make modifications to this limited warranty and you should not rely on any such modification.

State/Provincial Law Rights: This warranty gives you specific legal rights, and you might also have other rights that vary from state to state or province to province.

Limitations: Implied warranties, including those of fitness for a particular purpose and merchantability (an unwritten warranty that the PRODUCT is fit for ordinary use) are limited to one year from date of purchase. Some states/provinces do not allow limitations on how long an implied warranty lasts, so the above limitation might not apply to you. In no event shall the manufacturer be liable for any indirect, special, incidental, consequential, or similar damages (including, but not limited to lost profits or revenue, inability to use the PRODUCT or other associated equipment, the cost of substitute equipment, and claims by third parties) resulting from the use of this PRODUCT. Some states/provinces do not allow the exclusion or limitation of incidental or consequential damages, so the above limitation or exclusion might not apply to you.

Please retain your original sales receipt as proof of purchase.

Technical specifications

RF frequency band	1921.536MHz — 1928.448MHz
Channels	5
Operating temperature	32°F — 122°F 0°C — 50°C
Telephone base voltage (AC voltage, 60Hz)	96 — 130Vrms
Telephone base voltage (DC adapter output)	6VDC @400mA
Handset voltage	2.4 — 3.2VDC
Charger voltage (AC adapter output)	6VAC @300mA
Operating times*	Talk time (handset): up to seven hours Talk time (speakerphone): up to four hours Standby: up to five days

* Operating times vary depending on your actual use and the age of the battery.



www.telephones.att.com